

2023



Jindřich Neruda et al.

## Cableways in forestry

- MENDELU
- Faculty of Forestry
- and Wood
- Technology



prof. Ing. Jindřich Neruda, CSc. (the head of the author's team)  
Ing. Pavel Nevrkla  
prof. Ing. Vladimír Simanov, CSc.  
Ing. Luboš Staněk  
Ing. Tomáš Zemánek, Ph.D.

---

## **Cableways in forestry**

- **MENDELU**
- **Faculty of Forestry**
- **and Wood**
- **Technology**



### **Acknowledgment**

This publication was created with the financial support of the Erasmus+ project “European Forest Machine Operators Certification” 2019-1-UK01-KA202-061846.



Co-funded by the  
Erasmus+ Programme  
of the European Union

### **Author’s address:**

prof. Ing. Jindřich Neruda, CSc.  
Mendel University in Brno  
Faculty of Forestry and Wood Technology,  
Department of Engineering,  
Zemědělská 3, Brno 613 00 Czech Republic  
jindrich.neruda@mendelu.cz

### **Reviewers:**

prof. Ing. Valéria Messingerová, CSc., Technical University in Zvolen, Slovakia  
prof. dr hab. inż. Józef Walczyk dr h.c., Agricultural University of Cracow, Poland

### **English language proofreading:**

Ing. William Robb, BSc (Hons), Mendel University in Brno, Czech Republic

© prof. Ing. Jindřich Neruda, CSc. et al., 2023

© Mendel University in Brno, Zemědělská 3, Brno 613 00, Czech Republic

© ABA International

**ISBN 978-80-7509-960-0**

**<https://doi.org/10.11118/978-80-7509-960-0>**



Open Access. This book „Cableways in forestry“ is licensed under  
[Creative Commons Attribution 4.0 \(CC BY 4.0 DEED\) International License](https://creativecommons.org/licenses/by/4.0/)

**Contents**

1. Technical development of cable transport installations.....	4
2. Terminology of cable transport installations .....	6
3. Classification of cable transport installations .....	17
3.1 One-cable installations .....	17
3.2 Two-cable installations.....	18
3.3 Three-cable installations.....	20
3.4 Four-cable installations.....	22
3.5 Other ways of cableway classification .....	22
4. Main parts of cable transport installations .....	26
4.1 Cables, chains and chokers.....	27
5. Work technique at timber yarding by means of CTIs.....	36
5.1 Ways of unloading timber at CTI.....	40
5.2 Repair, maintenance and occupational safety.....	43
5.3 Algorithm of CTI choice .....	44
6. Designing CTI.....	44
7. Cable transport installations of the Křtiny research station (Czech Republic).....	47
8. References.....	51

## TIMBER HAULING BY CABLE TRANSPORT INSTALLATIONS

### 1. Technical development of cable transport installations

India, Japan, and China can be considered a cradle of cableways, where the indigenous people have been using primitive cables woven from climbing vines to overcome obstacles since ancient times. First entries of cableways and their use at transporting material or even people fall into the period from 1411 to 1440 in western countries.

Faustus Verantius designed a technically more sophisticated type of equipment in 1617. It was equipment with a skyline stretched between two towers, on which a carriage rode on blocks. The carriage was attached to an endless line that was powered by hand. Ladders attached to the towers were used to get on and off the carriage. Minimal attention was paid to cableways in the 17<sup>th</sup> and 18<sup>th</sup> centuries and they saw almost no development.

**Beginnings of cable timber skidding** can be found in the mid-19<sup>th</sup> century. Simple cable (wire) chutes were used first with a cable or wire stretched between the loading station and the site in the valley, along which the load hung on a hook, wire, chain or a simple block was lowered down to the landing. So it was a method of log sliding, which could only be used in sloping terrains. Cableways have undergone a significant expansion also during the World War I (1914 - 1918) when they were used on the Austrian-Italian front because the terrain of alpine areas required the construction of cableways to supply the army. These cableways were sold to timber traders at the end of the war. The cableways spread into Austria, Switzerland, Italy, and France.

A forest cable crane Wyssen was built in Switzerland in the first half of the 20<sup>th</sup> century, part of which was a technically perfect carriage equipped with a device for anchoring in any place of cableway route and with a possibility to secure the load in full suspension. The whole equipment consisted of a single-drum winch with its own engine that was pulled up by the chute to the working position at the upper route end. The drum with the skyline formed a separate unit. The skyline was drawn by means of an anchored winch and pre-tensioned by means of a tackle. Wyssen type cableways belonged to the most proven long-distance cableways in the nineties. They were used in mountain areas where slope roads and ridge paths were missing for economic reasons or due to inaccessibility of road construction in protected landscape areas.

Mayr-Melnhof Company that designed the first tower cable system in the second half of the 20<sup>th</sup> century contributed to **increased cableways mobility** and reduced time needed for assembling and dismantling cableways at the same time. Attention was paid to cable carriages at the development of cableways, too. The system of the ejection of mainline was however a problem. Initially, the mainline was ejected spontaneously using gravitation and manual pulling into the stand. An auxiliary line began to be used later, which ejected the mainline from the carriage. Designing self-propelled systems is currently a developmental trend in the area of cableway carriages, which has its pros and cons. The con may be a higher load of skyline, which can be solved e.g. by installing light electric motors powered by energy recharged by alternator during the operation.

Beyond the issue of improving cableway carriages, **a number of other issues** has been addressed. The problem of different drum speeds in systems with two and several drums belongs among the most frequently discussed ones. For example, it is necessary to brake and induce pulling force simultaneously in systems that work with the operating line and haul-back line to keep the load in semi-suspension, which causes different tensions in the lines, uneven jerky movement of carriage with the load and waste of energy. A waste of energy generates heat that has to be removed, which brings considerable design problems. These problems have been addressed by a so-called interlock recuperation system. The essence of the interlock system is such an interconnection (mechanical, hydraulic) of pulling and haul-back drums that allows a perfect synchronization of winding one drum simultaneously with unwinding the second one regardless of the changing number of cable layers that are wound on the drum. In other words, the system eliminates the change of winding radius.

At present, we meet quite often also with **cable tower systems** installed on automotive chassis, with the turning hydraulic crane and grapple which facilitate the handling of skidded timber. The crane is often

provided with a processor head instead of a grapple. In this case, the cableway can be successfully deployed at full tree harvesting when the skidded whole trees are cross-cut and classified to required assortments right at the cableway control station.

So-called **unconventional cableways** can be probably considered the more recent news. A separate autonomous movement of the carriage, in which all technological elements of activity are integrated (motor, lifting, downhill/uphill movement, control unit, fuels etc.) is the basic principle of these cableways. Two basic variants of these cableways have been developed in principle. The first variant works with one cable which represents a track as well as a driving cable at the same time. The second variant works with two cables. The skyline serves as a route only; the driving cable mediates the movement and serves at the same time as a safety device in the case that the skyline would break.

The foundation machine of cable transport installations (CTIs), their drive station, does not drive into the stand (logging site); this is why CTIs are applicable even where steep slopes, terrain obstacles, and grounds of low bearing capacity do not allow ground-based timber yarding. Timber yarding by means of CTIs awaits development because it features the following **advantages**

- yarding distance corresponds to the slope length, whereas slope roads needed for the movement of tractors on above-limit slopes extend the ideal yarding distance by up to 4 times.
- tractor (forwarder) weight and load ratio is usually 1:1 (up to 1:1.5 at dragging downhill); however, the weight of CTIs moving parts (carriage and cable) does not exceed 1/10 of the load weight.
- fuel consumption per 1m<sup>3</sup> is almost by a half lower in CTIs compared to wheeled tractors due to a shorter yarding distance and a more favourable ratio of displaced timber.
- CTIs do not require such a dense forest road pattern as yarding by tractors, which results in lower disturbance to area's geomorphology and in the lower removal of timber land from production.
- CTI operator controls the machine from the cab of standing machine or remotely. He is thus less exposed to vibrations, noise, and exhaust gases than when driving tractor across the terrain. As the risk of overturning can never be completely ruled out in machines travelling across the terrain, work safety of CTIs is higher than at tractor timber yarding.
- CTI drive station stands still and only the cableway carriage drives to the workplace. Thus, the physical wear of CTI is lower than that of tractor for timber yarding and its service life is longer.
- the speed of timber yarding by CTI does not depend on the terrain surface condition; this is why the CTI performance is balanced in practice irrespective of rainfall, while the performance of tractors is significantly impaired in muddy terrains.
- CTI advantage is friendliness to the transported timber as well as to the environment – the soil is not compacted and the soil surface disturbance has a superficial character. The scope and cost of post-production workplace treatment tend to be significantly lower than after timber yarding by tractors.

Despite its advantages, timber hauling by cable transport installations remains rather stagnant. However, the reason is not the principle as such, but above all the failure of the human factor consisting of the following manifestations:

- special-purpose forest wheeled tractors were fascinating in practice with their field accessibility, which reflects in their deployment under all production conditions, in which their terrain passability still proves well regardless of the damage caused. In other words, environmental aspects are underrated when choosing means for timber yarding.
- demand for CTIs went down due to the overestimation of special-purpose forest wheeled tractors, which led to their reduced development and moral obsolescence. After the renewal of demand, unsuccessful purchases of various CTIs types from the international market followed. Trust to domestic products is being restored at present that have not only succeeded in catching up with the loss at the technical level, but stand currently at the European top in a number of parameters.
- deformation of economic indicators is the overrating of the significance of direct costs for yarding 1m<sup>3</sup> of timber, which are 1.2 - 1.8 times higher for CTIs than for tractors. However, this indicator says nothing about the different extent and costs of post-production workplace treatment, different costs of building and maintenance of forest road patterns, risks of work, follow-up silvicultural operations and different extent of negative effects on forest ecosystems. Thus, a holistic perception

of forest management economics is missing and only isolated economic evaluation of individual production stages or even operations prevail.

- in terms of production preparation and control, timber hauling by cable transport installations is the most demanding of all timber yarding ways, that is why the easier looking methods suppresses it. Difficulties in obtaining qualifications for the operating and service staff also contribute to this – the qualification of a rigger cannot be obtained in any training centre and there are only few accredited organisations for training riggers. The fact that there is no legal regulation requiring certain special qualifications for CTI operators contributes to this situation, too. Thus, the minimum level of knowledge and ability to control and use CTIs properly are based on general regulations only, which is e.g. Act No. 22/1997 Sb., on Technical Requirements for Products (obligation of the manufacturer to place only safe products on the market and equip them with appropriate documentation including operating instructions, which the operator of the product is obliged to follow) and Government Decree No. 339/2017 Sb. laying down work and work procedure organisation methods that employers have to ensure in the forest and workplaces of similar nature.

## 2. Terminology of cable transport installations

An **adapter** (short tractor) **cable system** is a modification of double-drum tractor winch that works with or without the skyline, with or without the high outlet of cables (tower). In the simplest variant without the skyline, one cable (acting as a haul-back line) retracts the other cable (acting as a mainline) over the block back to the stand so that it is not necessary to retract the mainline to the stand manually. It must be borne in mind when using this system that an effective route length may be only one half of haul-back line length. The range of these systems is up to 150 m because the drum sizes of tractor winch are limited.

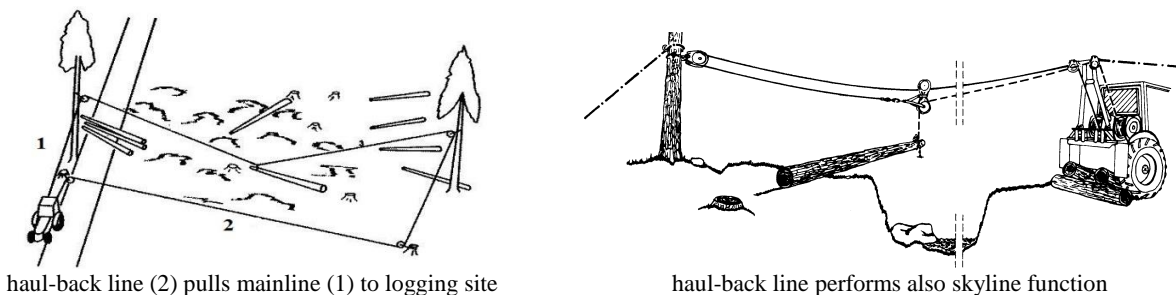
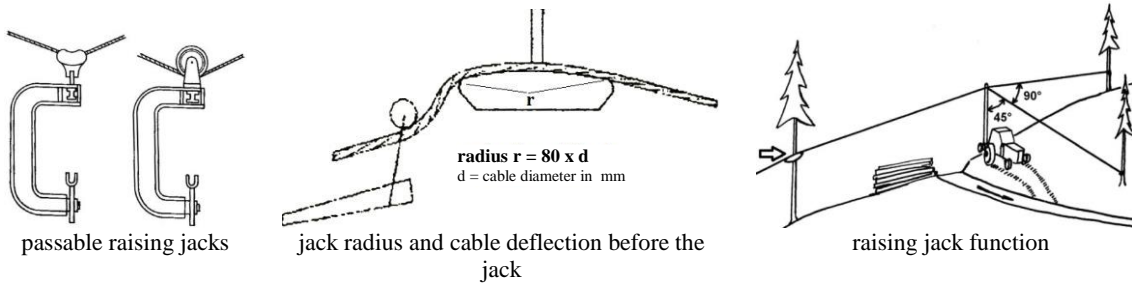
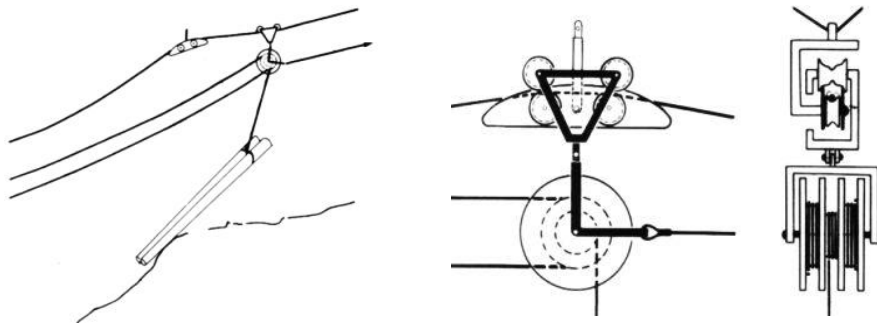

Fig. 1. Examples of adapter cable systems

A **jack** is a part of the support system of skylines. It is hung on **natural supports** (trees), **semi-artificial supports** (a combination of trees and reinforcing supports), and **artificial supports** by means of cables at a height specified by the project. A **raising jack** is used for increasing the terrain clearance (positive gradient change of route) and a **lowering jack** is used for decreasing the terrain clearance (negative gradient change) - for practical reasons we try, however, to select cableways route so as to avoid using the lowering jack. The jack consists of a web (ended usually with a pulley for transverse cable at the top) and swinging arm with a bearing channel. Its shape must facilitate a two-sided passage of cableway carriage, a minimum radius of its curvature  $r$  must be  $r = 80 \times d$ , where  $d$  is skyline diameter in mm. To be used as a raising jack, the arm turns the channel upwards and the skyline is inserted to the channel from above; to be used as a lowering jack, the arm turns the channel downwards and the cable is inserted to the channel from below. The arm is fitted with catches against cable falling out from the bearing channel. At the end of the route, an **impassable jack** is used that keeps the cable at a required height, but the carriage does not pass over it. The point of cable deviation on the impassable jack must not be acute.



**Fig. 2. Passable raising jack and its function**



**Fig. 3. Cableway carriage passing over raising jack**

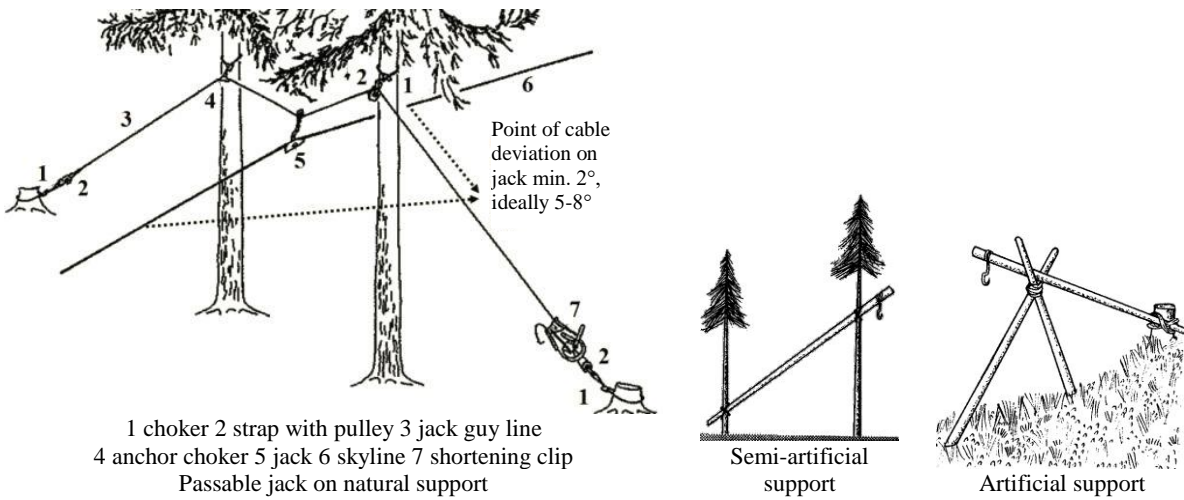

**Fig. 4. Supports – natural, semi-artificial, artificial**

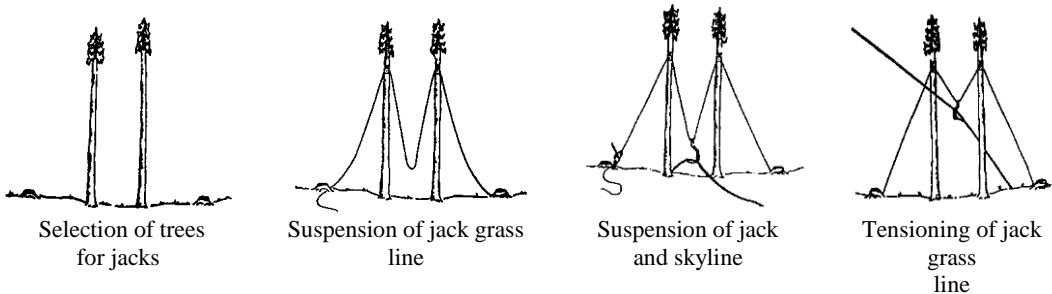

**Fig. 5. Sequence of operations in the construction of a passable natural support**



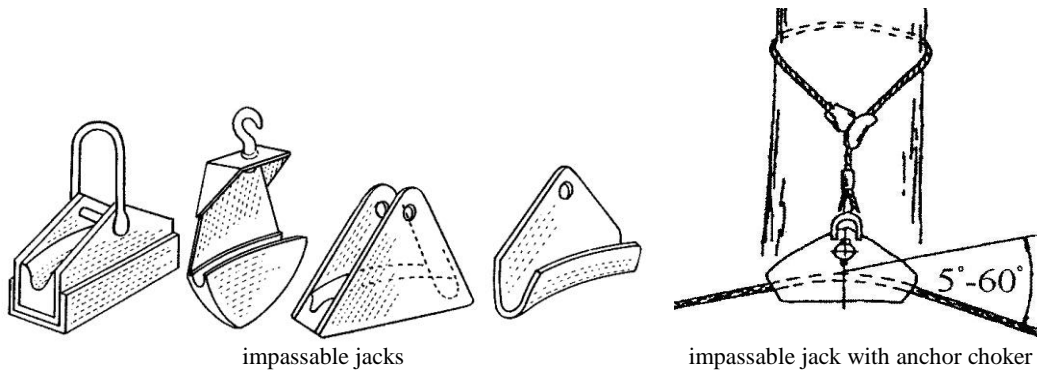

Fig. 6. Impassable jacks

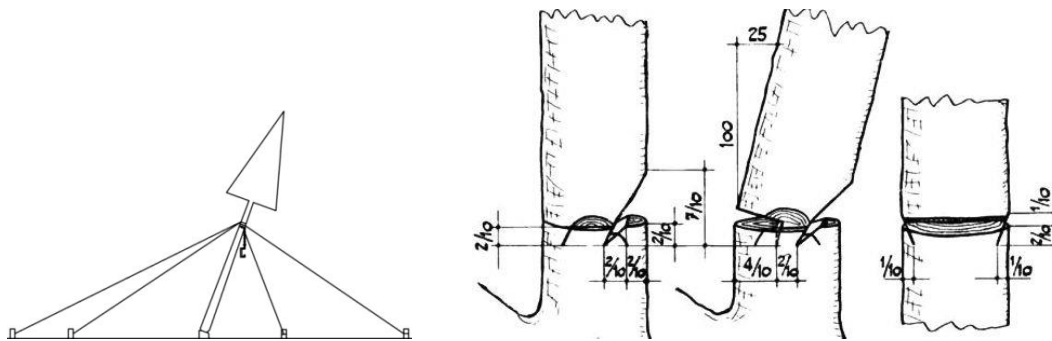

Fig. 7. Construction of a semi-artificial support from a notched tree

**Allowable cable stress**  $S_{Dov}$  is the magnitude of force (in N) that we can strain a cable by construction and project design without exceeding the prescribed level of safety.

**Wire and cable chutes** allow the gravity transport of stacked timber after the manual hanging of loads on a wire (cable). The used chokers must be transported back to the workplace.

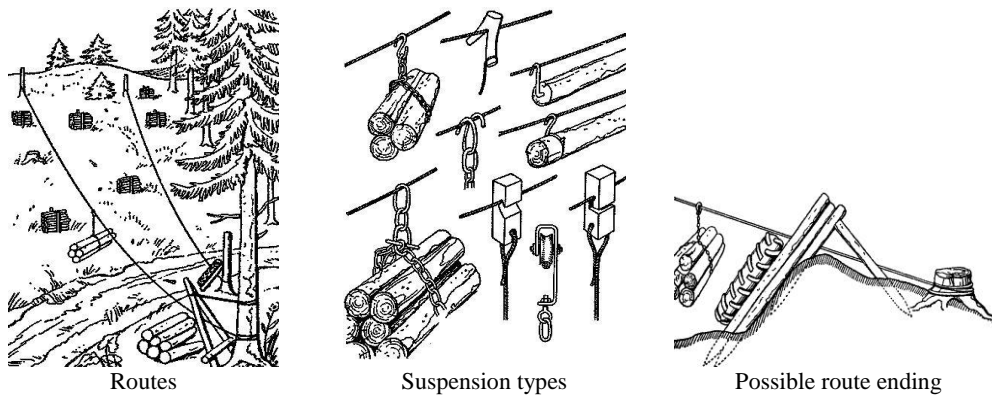

Fig. 8. Cable (wire) chute

A **pulley** is a rotating disc, on the circumference of which there is a groove for cable guiding. Since the groove width should be 1.06 - 1.08 of cable width, there must be a larger number of pulleys of different widths available for work with cables of different widths (too narrow pulley deforms the cable elliptically in height, too wide pulley deforms the cable in width).

A **fall pulley** is a free pulley provided with a hook for fastening choker hung on the mainline. Its weight ensures that it is lowered along with pulling out the mainline via carriage pulley embracing the fall pulley and ending on the carriage. The fall pulley performs a function of power pulley when the load is removed from side and lifted. Its pulling to the logging site is strenuous due to its weight which must pull down also the free end of the mainline.

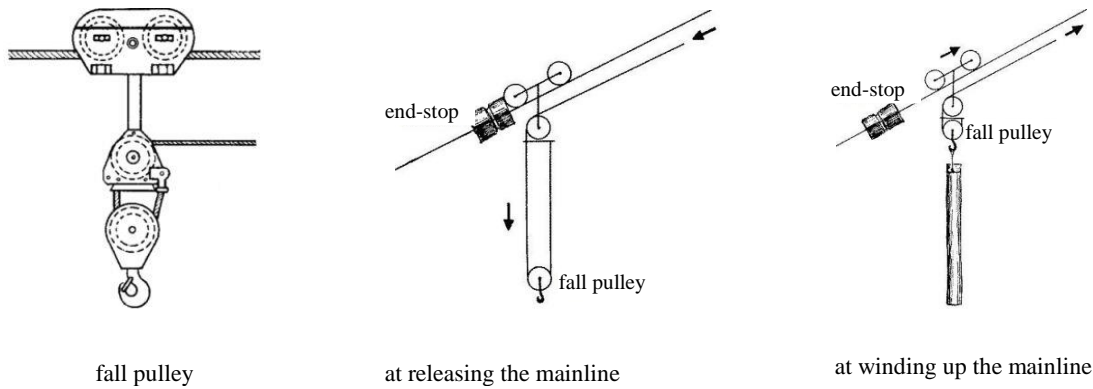
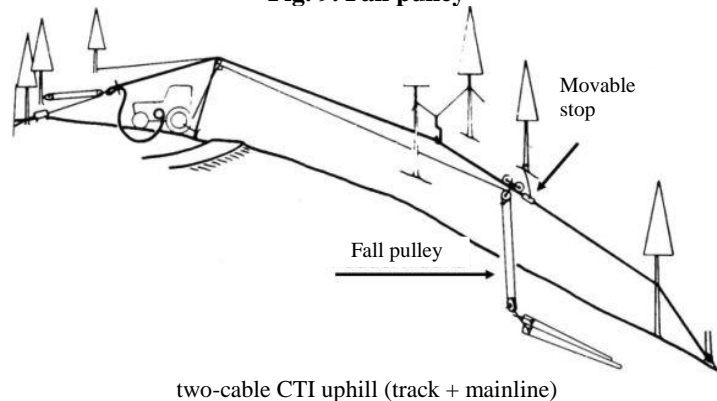

Fig. 9. Fall pulley

two-cable CTI uphill (track + mainline)  
Fig. 10 Using a fall pulley at timber yarding

An **anchor tree** is a tree of adequate dimensions serving to anchor CTI cables. Its stability for the skyline is verified by calculation. In order to prevent damage to trees by the cable at least temporarily, a protective collar should be used at anchoring. To tie the cable to a live tree is possible if the tree is marked for felling. (The lifespan of trees used as anchors is limited anyway because alternating forces acting on them during the CTI operation usually disturb their root systems). It is possible to anchor to several trees (if anchoring just to one tree would be insufficient), to stumps and to artificial anchors. In such a case, the first tree carries a load of 100%, the second and the third tree 10-40% and 1-10%, respectively. This rule should govern the selection of trees according to their diameters. The first to be assessed in selecting the trees is their health status. If possible, solid trees that can be uprooted by wind are excluded. An evaluation of the root system and direction of main roots against the assumed direction of traction should be made. The guy line should be led as low as possible above the ground and should not stress the anchor by torsional forces. **Fresh cut stumps** are more appropriate as anchors because forces caused by the tree crown are eliminated after the tree felling and it is possible to make a notch to the stump for cable fastening. Out of caution, **older stumps** must be larger than fresh stumps.

An **anchor** is a place in the terrain to secure (anchor) the ends of CTI guy lines (skyline and cables carrying jacks). **Natural anchors** (adequately sized stumps and trees) and **artificial anchors**, logs stuck between trees, bored anchors (anchor spikes), concrete blocks (on permanent polygons), anchor logs embedded in trench (so-called "dead men"), and ballast loads (braked machines of adequate weight – e.g. dozer) are usual. A "dead man" has the following parameters: log length  $b = 4$  to  $6.5$  m, log diameter  $30$ - $45$  cm, burying depth  $h = 1.5$ - $1.8$  m.

**Anchoring of supports** stabilise the supports by means of cables against deflection. The number of cables and their location must be verified by calculation or in a graphical form so that the pressure on the support passes through its axis and acts on buckling rather than on bending.

Criterion	Favourable conditions f = 2	Normal conditions f = 3	Bad conditions f = 5	Very bad conditions f = 8
Operating time	1-3 days			
vitality	healthy trees	healthy trees and stumps	stumps with falling bark	old stumps
roots	healthy root system going deep	good, roots with high bearing capacity	dead fine roots, root system holds weakly	
type of roots	flat roots under favourable conditions, deep roots under normal conditions	heart-shaped and flat roots under normal conditions		
angle of anchoring	up to 15°	30°	30-45°	
soil	deep, fresh*	soil class 6-10	stony, water-logged, sandy, gravel, old disaster areas	terraces of gravel, sands, weathered rocks, smooth rock platforms, water-logged soils, fresh disaster areas
weather	favourable, without intensive precipitation		rainfall, snow melting, gust wind	thaw, storms, large precipitation totals, wetting of the soil
checking		regular	continuous	continuous
others			frequent shocks on anchors, red rot	very strong rot

\* Attention – roots tend to be weak in very good soil classes!

**Table 1. Conditions affecting the choice of the correction empirical factor of bearing capacity in trees and stumps**

d <sub>1,3</sub> cm	Bearing capacity of trees and stumps depending on conditions (t)			
	Favourable conditions factor 2	Normal conditions factor 3	Bad conditions factor 5	Very bad conditions factor 8
20	2.0	1.3	0.8	0.5
25	3.1	2.0	1.2	0.75
30	4.5	3.0	1.8	1.1
35	6.0	4.0	2.4	1.5
40	8.0	5.3	3.2	2.0
45	10.0	6.7	4.0	2.5
50	12.5	8.3	5.0	3.0
55	15.0	10.0	6.0	3.7
60	18.0	12.0	7.0	4.5
65	21.0	14.0	8.0	5.2
70	24.5	19.0	9.5	6.0

**Table 2. Indicative values of the bearing capacity of anchor trees and stumps under different conditions**

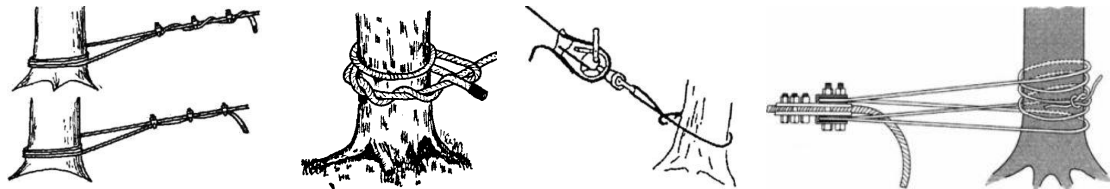

**Fig. 11. Different ways of anchoring on individual trees**

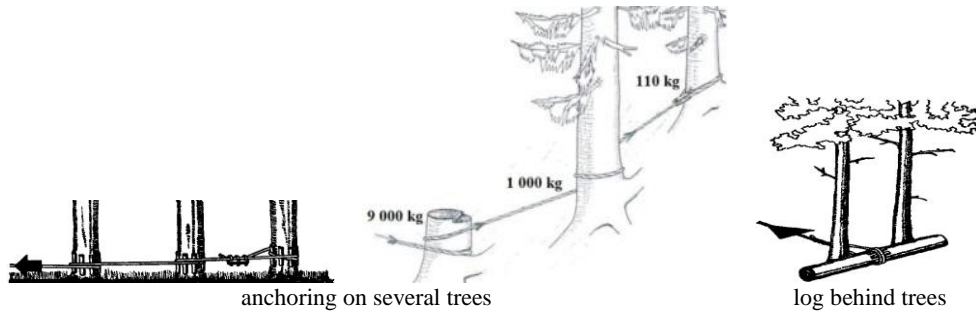

**Fig. 12. Different ways of anchoring on several trees**

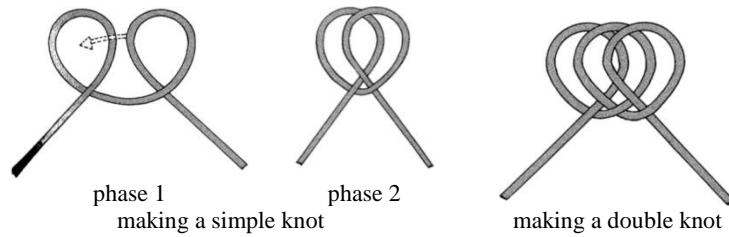

**Fig. 13. Making simple and double knots for anchoring to stumps**

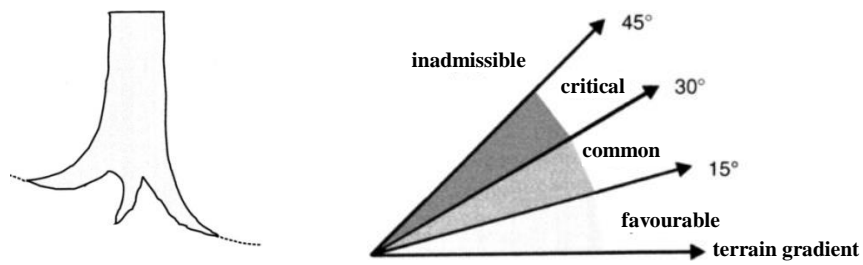

**Fig. 14. Anchor stress directions**

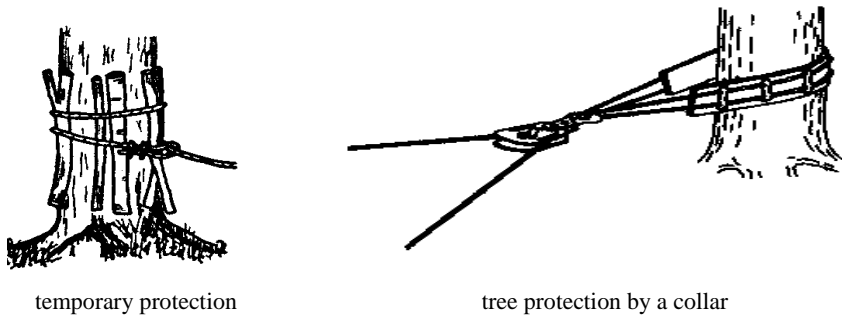

**Fig. 15. Protection of anchor trees**

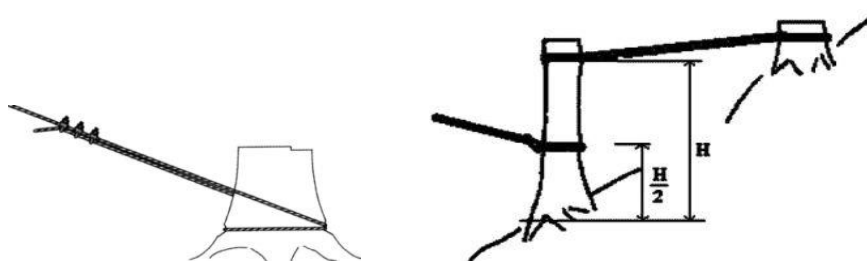

**Fig. 16. Anchoring on stumps**

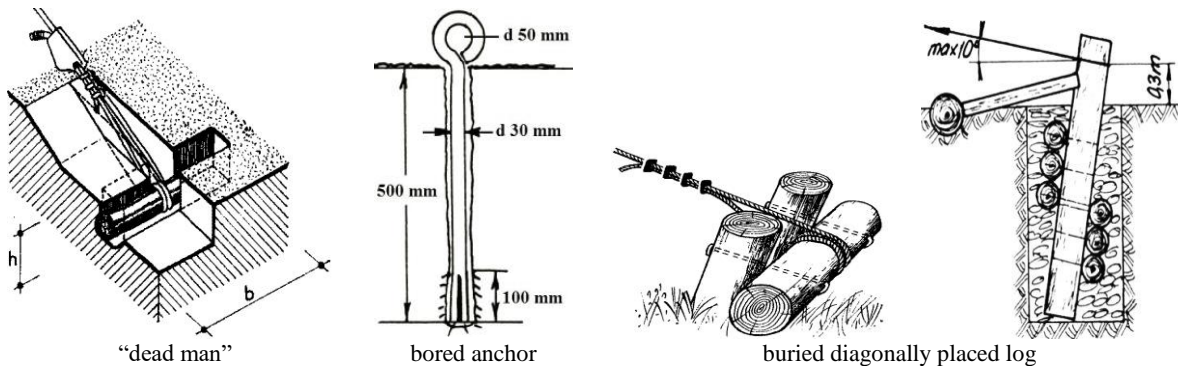

Fig. 17. Ways of anchoring to artificial anchors

A **Capstan** transferring the circumferential force from the drum to the cable is a drum encircled with the endless line which is set into alternating two-way motion by changing the sense of drum rotation, which changes the direction of the endless line movement.

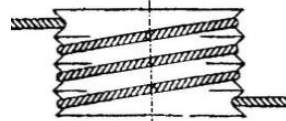

Fig. 18. Capstan

**Cable transport installation (CTI)** is the broadest term in meaning, since it also refers to the equipment transporting timber by dragging on the ground, and therefore without a skyline.

The term **cableway** should be formally used for equipment with the transport function only, because cableway does not skid the timber nor lifts it under the skyline. This is why it must have a loading and unloading platform. However, the term cableway is commonly used in forestry without matching the superior technical terminology of cable and lifting equipment.

**Cableway cranes** transport a load on routes with several spans, skid timber from the logging site to the route, lift load to the skyline and lower it at the landing.

**Cable cranes** perform the same technological functions as cableway cranes but on the route with one span only.

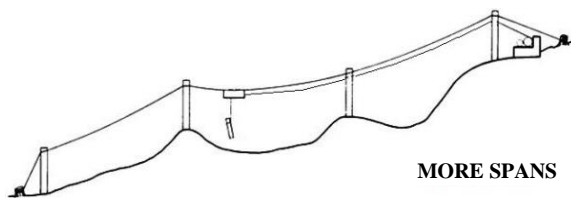

Fig. 19. Cableway crane

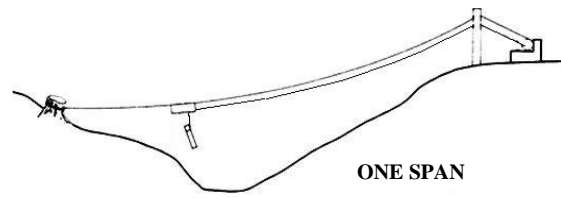

Fig. 20. Cable crane

**Cableway carriages** are used only in systems with the skyline and they are simple, automatic, both remote controlled and motor driven. They move on travelling rollers on the skyline onto which they are inserted from above by sliding through movable latches which hold the carriage on the skyline during the movement, jump inside when passing over a jack and then return back again. This is why the cableway carriages are relatively long so that a carriage is secured by one pair of latches at least when passing a jack. Even so it may happen that the carriage breaks free from the cable when passing the jack. That is why it is necessary to adhere to the prohibition of the movement of persons in the endangered area. A **carriage with the motor driven extension of mainline** is based on the three-cable (track + operating + haul-back) CTI. It moves on the skyline that is anchored at both ends and tensioned. To grasp the free end of the mainline is made possible by the motor which is located in the carriage and connected with the mainline pulley via centrifugal clutch. This connection is open when the motor is idling and the pulley is free for a two-way cable movement. The clutch engages when the motor speed increases (by radio remote control) and spins the mainline pulley outwards – by which it extends the cable free end to the logging area. The motor speed is reduced again after a sufficient cable length is extended; the pulley then becomes released and is used for skidding timber under the skyline. Unlike in

the system with the free end of the mainline extended using an auxiliary wire, the auxiliary wire does not move under the skyline, which complicates the operation. It is logical that this carriage can be used on CTIs only with the motorised skyline shutdown. Refuelling and carriage adjustment would mean too much work in manually tensioned cables.

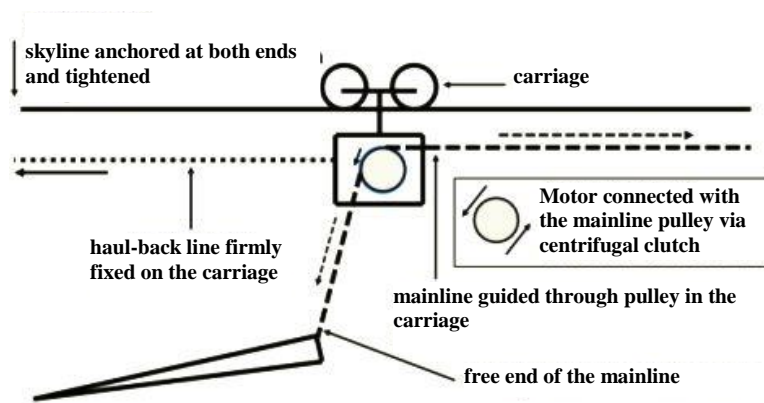

Fig. 21. Carriage with motorised extension of mainline

**Cable clip** (screw cable clip), a “blajchrtka” in rigger slang, is used for non-destructive shortening and connecting of cables if they do not pass over the pulleys (see Chapter 16.8).

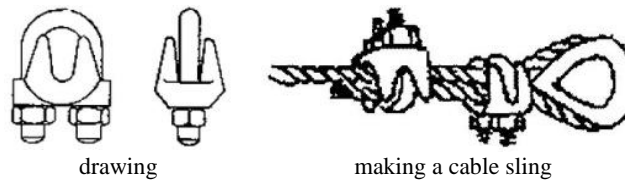

Fig. 22. Cable clip and its use

**Cable jaw winch**, an equipment originally intended e.g. for freeing vehicles, is used for manual tightening of cables (a “hupcuk” or a “tirfor” in rigger slang – according to one of the manufacturers). Small portable winches driven by power saw engine (e.g. Hit Trac 16 type) also exist.

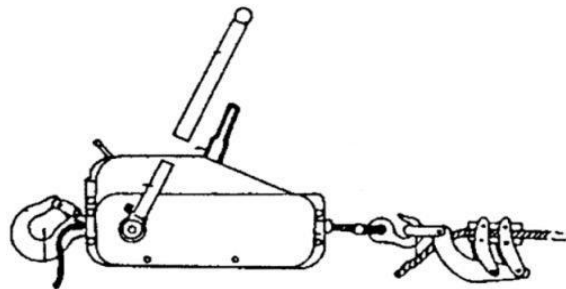

Fig. 23. Manual jaw cable winch

**Maximum tension**  $S_{Qmax}$  is the greatest force (in N) in the skyline axis induced by the weight of load and cables, by the assembly force and by environmental influences. It must not be greater than the allowable cable stress  $S_{Qdov}$ . The maximum tension is verified by calculation that comprises allowable cable stress and maximum load weight.

**Jack grass line** is used to hang jacks. It is usually provided with a steel hook at one end and shortening clasp is slid at the other end.

**Assembly stress**  $S_m$  is a force (in N) in the cable axis, by which the cable is tightened for a specific operation.

**Assembly stress of skyline** is determined by calculation and depends on the cable nominal carrying capacity, allowed cable load, route length and number of spans.

**Skyline stress** is a magnitude of force acting in perpendicular direction to the cross-sectional area of skyline. We distinguish an assembly stress that is permanent and a maximum stress that arises as a result

of dynamic effects of the movement of laden cableway carriage. The maximum stress can reach to 300 - 600 % of assembly stress value.

**Tension pliers** consist of a pair of self-locking jaws, between which a tensioned cable is inserted. The cable end of cable jack (slack adjuster) is hooked into the eye of pliers, by the shortening of which the cable held by self-locking jaws is gradually tightened. To achieve the required cable tension, the tension pliers usually have to be shifted several times (after the cable has been secured). The cable is preferably prestressed by winch cable pull and then stressed by the cable jack.

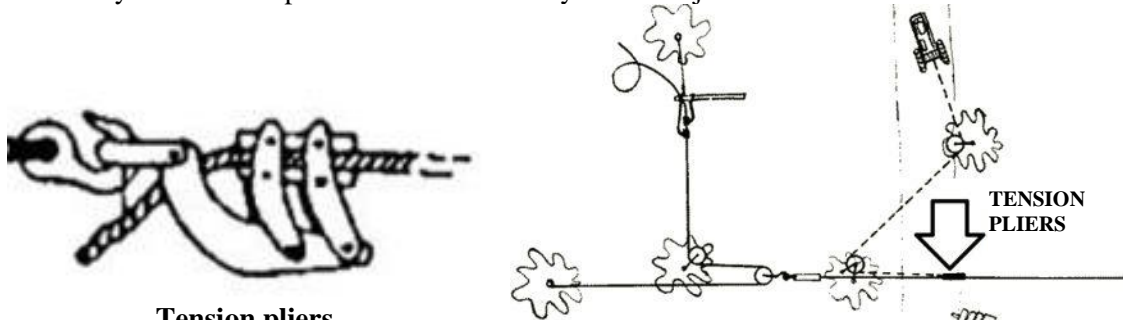

**Tension pliers**

**Fig. 24. Tension pliers and their use for cable prestressing by means of tractor winch**

**Winding spiked roller** is intended for storage and transport of all types of auxiliary lines. Each auxiliary line is wound separately and held together by straps.

**Endless anchor choker** is a braided cable used as a connecting link between the skyline end-piece and the tensioning pulley block.

**Skyline** is used for cableway carriage travelling and keeps the load above the terrain.

**Endless line** is set into motion by the capstan and is used for the movement of loaded or empty cableway carriage in CTI with the fixed cable.

**Towing from the skyline** (rolling away) is used when the timber cannot be stored under the CTI skyline or the number of trees and logs does not allow it. The skidded timber is towed by a tractor (rolled away manually) to landings outside the skyline. A disadvantage is that another machine (tractor) must be included; an advantage is that it is not necessary to shut down the CTI operation at loading timber on haulage means. This is used at whole tree harvesting when trees are delimited during the towing (using processor, branch-trimming unit).

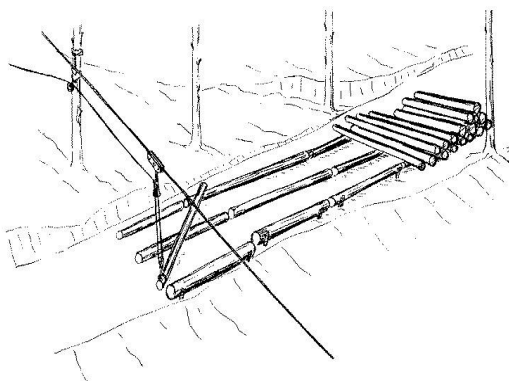

**Fig. 25. Rolling away from the skyline**

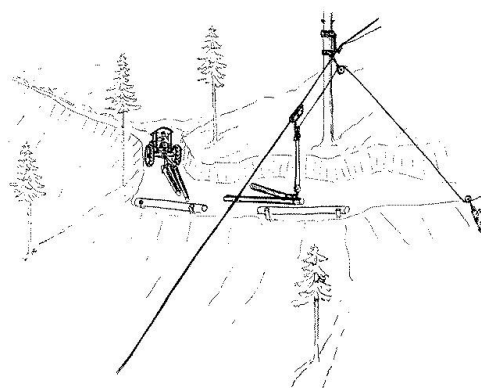

**Fig. 26. Towing away from the skyline by tractor**

**Support tree** is a tree, on which a raising jack including cables for its fastening is located.

**Power aggregate** includes a power supply and equipment for the transmission of driving and braking forces onto working cables.

**Auxiliary line** performs auxiliary functions in the system, e.g. releases actively the end of the mainline or shortens/extends the sling of the endless line in running systems.

**Cable sag** is the size of line (in meters) drawn in vertical direction so that marginal points of the line are an arbitrary point of the field chord and an intersection point with the skyline which is loaded with a burden in that point. The maximum cable sag occurs when the burden is in the middle of the span. The magnitude of cable sag is verified by calculation or graphically.

**Cable deflection** is the size of line (in meters) drawn in vertical direction so that marginal points of the line are an arbitrary point of the field chord and an intersection point with the cable loaded by its own weight only. The maximum deflection is in the middle of span.

**Distributor of anchoring forces** is a simple equipment consisting of three pulleys, which allows the distribution of axial force in the cable onto four (two) anchor points. If the distributor is used only for two points, one cable is drawn over both pulleys.

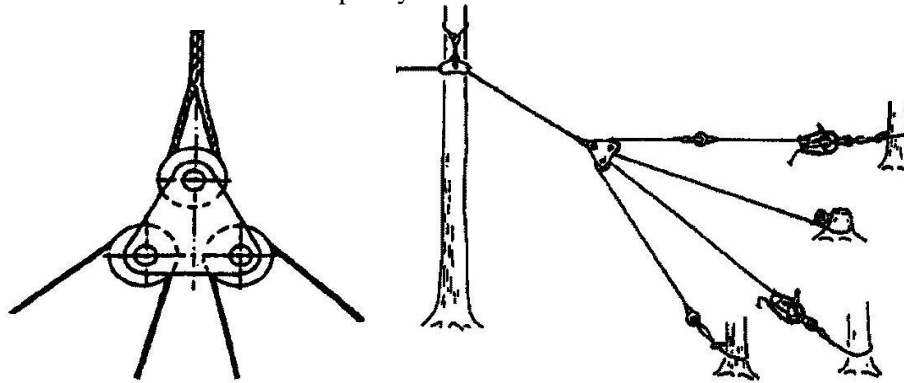

Fig. 27. Distributor of anchoring forces and its use

**Cable guider** is a device for regular cable winding all over the winch drum width. The cable guider can be replaced by a corner block upstream the drums at a distance at least 30 times greater than the drum width.

**Mast tree** is a tree with the last, impassable jack, the location of which is determined by the difference between the effective route length and the assembly route length. Corner blocks of operating and haul-back line circuits are hung on it, too.

**Trees for guiding the working cable circuits** are trees on which the corner blocks of operating and haul-back line circuits are hung.

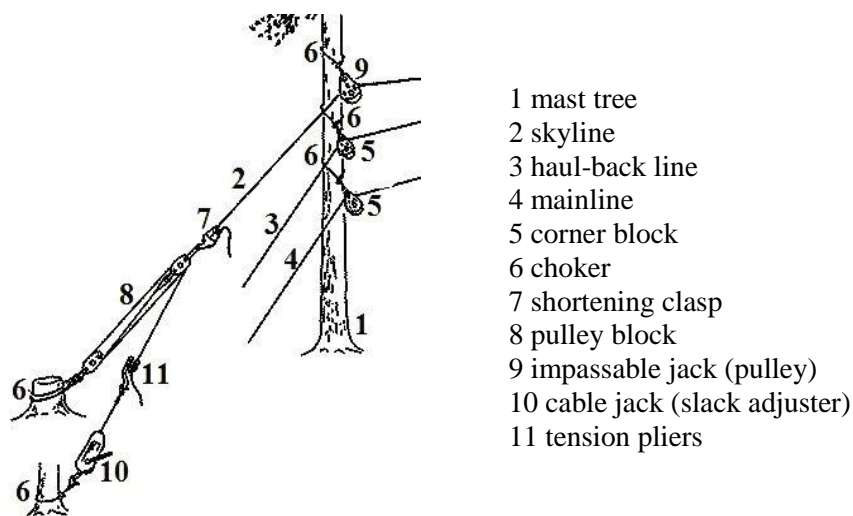
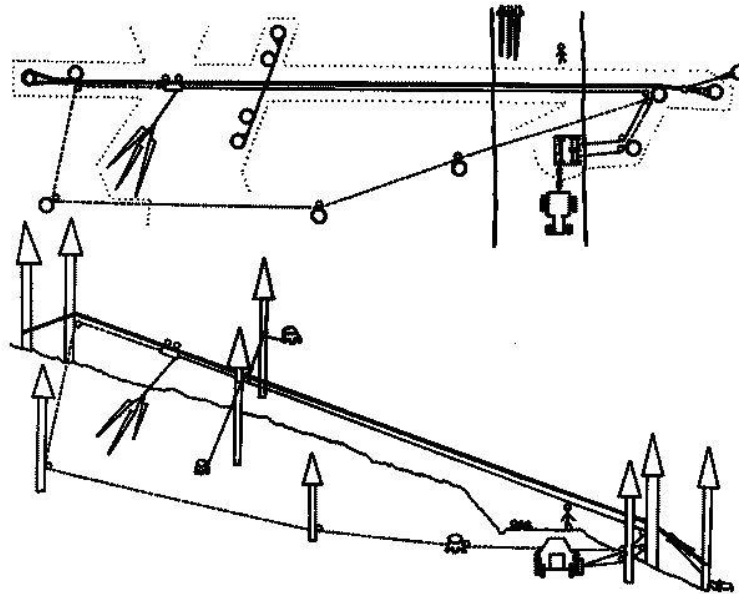

Fig. 28. Mast tree with impassable jack





Whole-stem (logging) method, downhill timber hauling, towing timber off the skyline. Cables, trees for guiding working cable circuits, support, mast, and anchor trees are illustrated.

**Fig. 29 Plan and view of universal CTI model route (track, operating, haul-back lines)**

**Mainline** is intended to clear the load from the working span to the skyline and for the movement of laden cableway carriage from the place of load assembly to the unloading place.

**CTI route** is a 1.5 - 4 m wide transport corridor making the stand interior accessible.

**Laying-out** is a set of works related to the terrain survey, CTI route alignment, elaboration of longitudinal route profile, and transfer of data on the longitudinal profile back into the terrain.

**Point of cable deviation on the jack** is an angle, the arms of which are tangents of the cable immediately before the jack and behind it. The point of deviation at a jack  $\gamma$  (angle of the deviation of chords of two neighbouring spans) should be at least  $2^\circ$  at least,  $5 - 8^\circ$  ideally, so that the skyline is pushed to the groove at the jack constantly and does not tend to fall out. Being calculated or graphically plotted, the maximum angle of cable deviation at a jack may be theoretically  $17^\circ$ ; in practice, it is higher in operation being laden with the carriage and its load.

**Haul-back line** stabilizes the cableway carriage position on the skyline at extracting timber and is used to transport the carriage back to the logging site after it has been unloaded.

**Back-stop** is used especially in simple CTIs for uphill haulage, at which it demarcates the range of cableway carriage motion on the skyline. the back-stop guy line is anchored against the direction of skidding to stabilize lateral deviation of the skyline. The back-stop must be constructed so that it glides freely on the skyline and allows pulling over jacks.

**Shortening clip**, usually designed as a **wedge clip** with the self-locking function, is used for non-destructive shortening of the cable if variable lengths are needed, and as a connecting link between the cable and tensioning equipment. The clip is not symmetrical and this is why the guidance of the operating and free cable parts must be respected otherwise they are deformed.

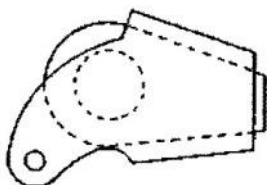

**Fig. 30. Shortening wedge clip**

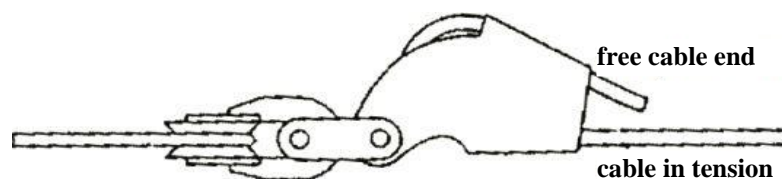

**Fig. 31. Shortening wedge clip between cable and tensioning equipment**

### 3. Classification of cable transport installations

Technological properties are important at deciding on CTI operational deployment. As it closely depends on the structural design, it is necessary to classify the CTI into groups informing about the structural design and practical applicability. The following classification criteria are used in practice:

#### Method of load suspension

- **dragging on the ground**, at CTIs without the skyline (O+HB)
- **semi-suspension** at which one stem end is lifted to the carriage and the other end is slipped on the ground (carrying capacity is dimensioned to half load weight ( $Q/2$ ) because a half of the load weight leans on the ground)
- **full suspension** - carrying capacity is dimensioned to full load weight ( $Q$ )
  - **simple full suspension (hanging position)**, at which the log (stem) hangs vertically on one choker
  - **horizontal full suspension**, at which the stem is hung on two chokers parallel with the skyline, therefore this transport method requires special cableway carriages.

#### Number of cables

##### one-cable installations

- wire and gravity cables
- endless line systems
- CTIs consisting of skyline and cableway carriage powered by motor of its own

##### two-cable installations

- system of skyline and mainline (T+O)
- system of skyline and endless line (T+R)
- system of mainline and haul-back line (O+HB)
- system of mainline and haul-back line functioning as a skyline (O+HB/T)

##### three-cable installations

- system of skyline, mainline, and haul-back line (T+O+HB)
- system of skyline, running, and auxiliary line (for the shortening and extension of endless line sling), (T+R+A)

##### four-cable installations

- system of skyline, mainline, haul-back line, and auxiliary line (for the forced extension of mainline from the carriage), (T+O+HB+A)

##### multi-cable installations

- Some manufacturers declare their CTIs as multi-cable installations. This signals that such a CTI has other cables tensioned by motor in addition to the above-mentioned cables, e.g. various numbers of guy lines. These affect only the speed and convenience of CTI assembly and dismantling and are not functional in timber yarding.

#### 3.1 One-cable installations

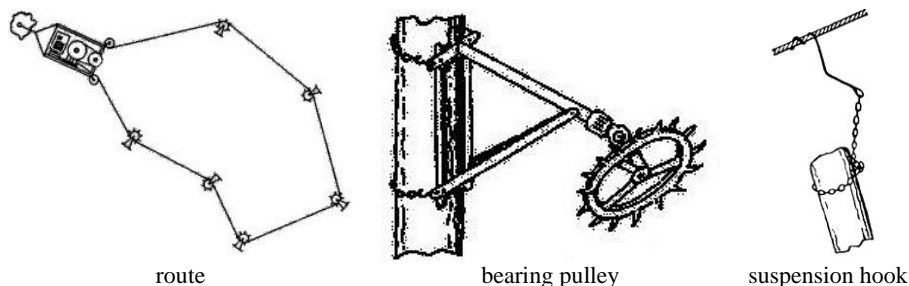

Fig. 32. Lasso-Cable running one-cable system

The Lasso-Cable running systems with one cable that are historical today (even though they are used occasionally – e.g. in Slovakia) were intended for hauling stacked timber (1 m) only. Their routes had to be low above the ground (needed a large number of bearing pulleys), because bolts were hung upon the moving cable by hand and were taken down on the move at the landfill as well. Bolts on chokers were hung on the cable by means of suspension hooks with a spiral end-piece (so-called pig tail), through which the cable was running when relieved (hanging and taking down) and which tightened on the cable under the action of bolt weight (at suspension) and the bolt was carried on by the endless line. Bearing pulleys and corner pulleys were of finger type on the points of route gradient changes to facilitate the passage of the spiral end-pieces of suspension hooks.

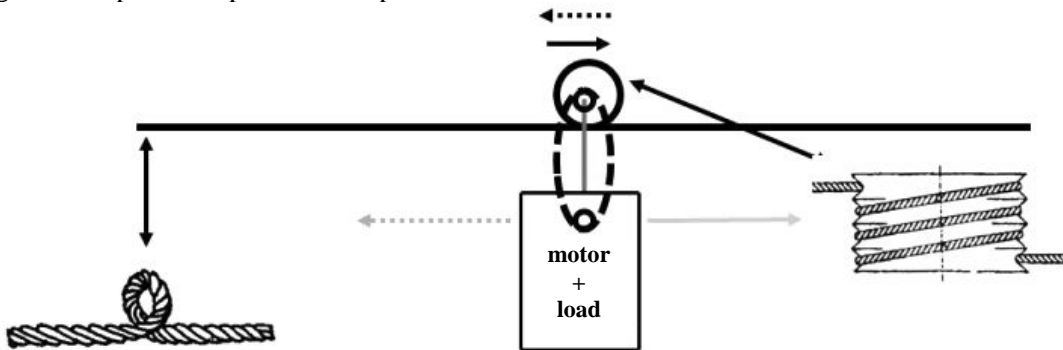

Fig. 33. One-cable system with the skyline and cableway carriage powered by its own motor

**One-cable CTI** with motor powered carriage movement has a loosely tightened skyline anchored at both ends wrapped around the motor-powered pulley (capstan) which “is shifted” on the skyline in both directions by changing the direction of rotation (together with the motor and the load). These systems are used for timber haulage exceptionally only at intermediate felling, more frequently for transporting transplants in mountain areas and most often for supplying mountain huts and settlements.

### 3.2 Two-cable installations

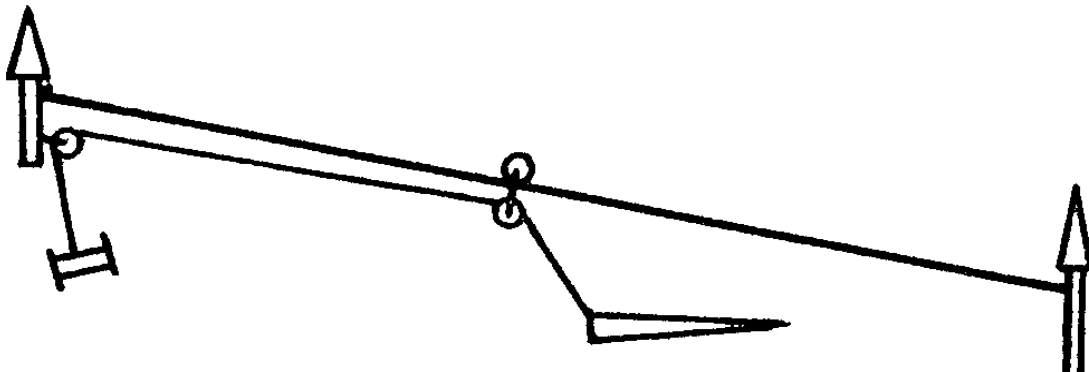

Fig. 34. Cable transport installation T+O (skyline + mainline)

In the **track and mainline system** (T+O), only the uphill timber hauling is possible because the carriage driving downhill to the logging site is made possible only by gravitation. To achieve a reasonably fast carriage, return to the logging site (the carriage pulls also the mainline from the drum by gravitation), the route inclination must be 15 % and more. As to the construction and operation, it is the simplest cable system with only one winch being controlled. The operation can be simplified by using a drop pulley and a movable back-stop. The carriage hits the back-stop at the end of the route and the drop pulley pulls the mainline to the ground. However, as the load assembly with the drop pulley is strenuous, various tricks are used to get the mainline to the ground even without it. To prevent “jumping” of the load during transport, a “pear” can be used, which holds the load at the same height after it is lifted to the skyline. On the landing, the carriage drives into the back-stop, which releases the “pear” and the load falls to the ground. In selective felling, the carriage has to be arrestable at any distance so that the angle of skidding does not change.

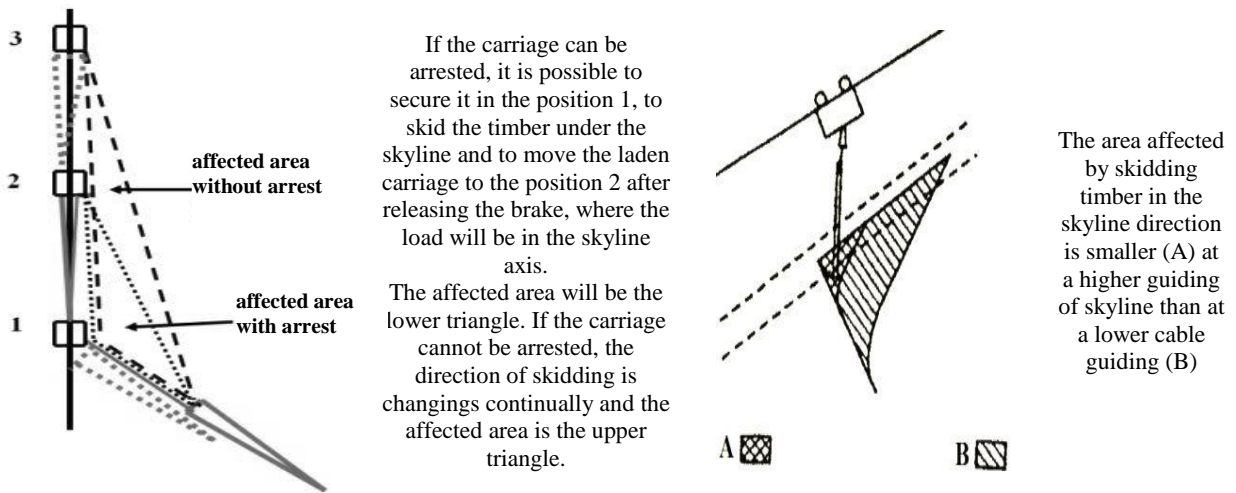

Fig. 35. Area affected by timber skidding in selective felling

Using directional pulleys for timber skidding under the skyline in selective felling is an exceptional procedure because it is very demanding and labour-intensive.

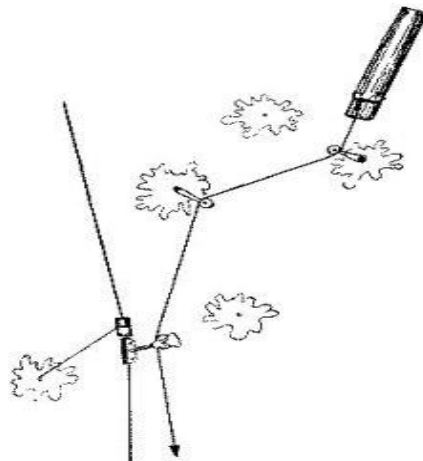

Fig. 36. Skidding under the skyline using directional pulleys

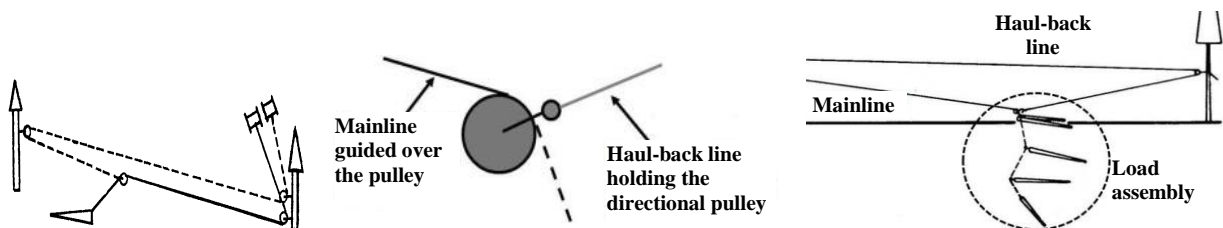

Fig. 37. Cable transport installation O+HB (operating + haul-back), pulley detail and load assembly

In the simplest case of a **system of operating and haul-back lines (O+HB)**, ends of both cables may even be connected firmly by coupler, a so-called “C”, into which chokers will then be snapped, too. However, skidding timber from the side of the route is very limited by that. The illustrated solution is more usual, at which the mainline enabling timber skidding from the side of route passes through the end (directional) pulley of the haul-back line. As the timber cannot be lifted above the ground level, it is in both cases dragged on the soil surface. Pulling out the end of the mainline is strenuous and while winding-up one drum, the operator must brake off the other drum.

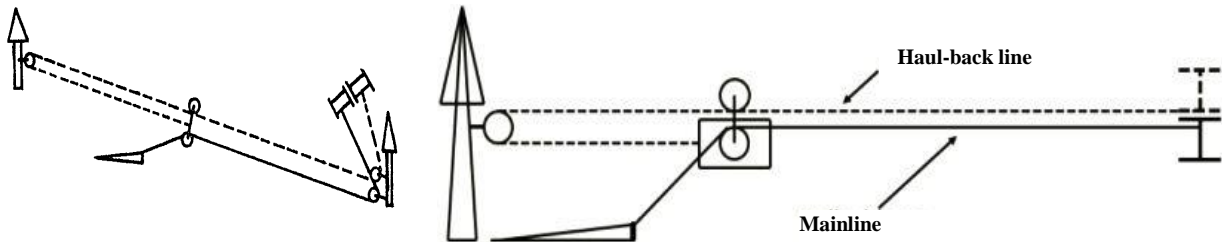

Fig. 38. Cable transport installation O+HB/T (mainline + haul back line in the function of skyline)

The haul-back line is guided over the pulley, and the cableway carriage is carried through its branch between the winch and the route end. Thus, the haul-back line performs the function of the skyline while maintaining the function of the haul-back line, i.e. returning the carriage to the logging site. Terrain slope does not influence the system functionality. This system is mainly offered in cable systems adapted from a double-drum tractor winch. Route construction is simple but operation is difficult because pulling out the end of the mainline is strenuous and the final braking of the haul-back line is demanding. The drum of the haul-back line has to be braked-off when winding-up the mainline; however, the drum must be braked slightly “by feeling” so that the drum does not start to turn and the cable “does not fluff” on the drum (because a tangled mass would arise upon the next tightening). It is therefore impossible to keep the load above the ground permanently (it jumps up and down) and it happens that cables “swop” over one another. This system is not favoured by cableway crews.

### 3.3 Three-cable installations

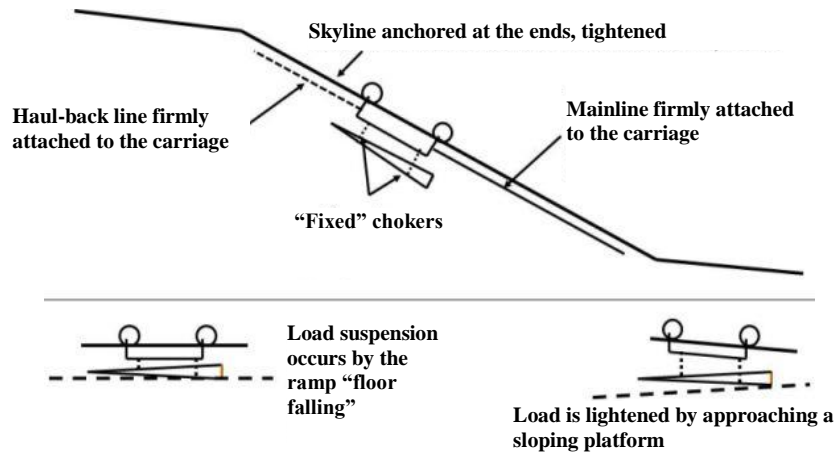

Fig. 39. Hauling cableway Valtelina, system with track, operating and haul-back lines

The main function of **hauling cableways** (Valtelina type in the 1950s in the Czech Republic) was transport and therefore they were used in areas with insufficient transport network and for timber haulage across watercourses. **They do not skid timber from a stand and do not lift it to the skyline.** That is why they must have loading and unloading platforms.

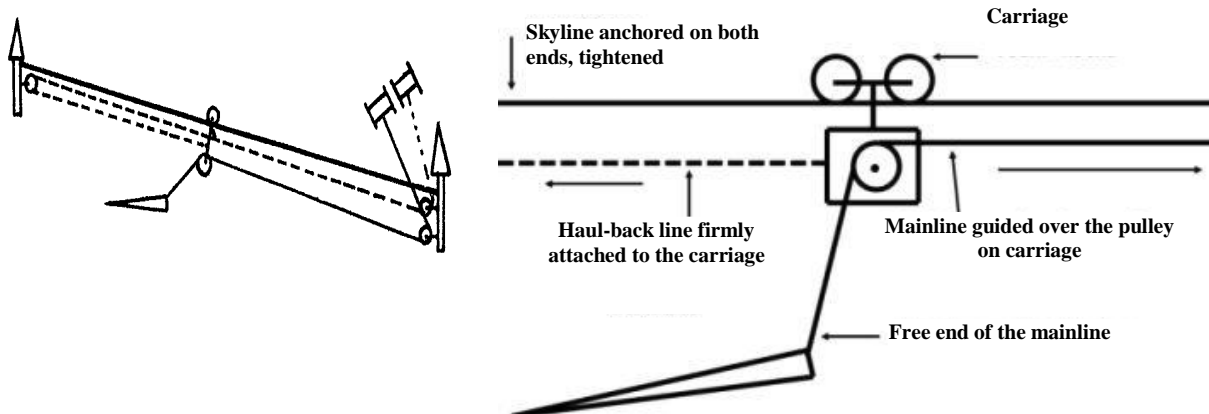

Fig. 40. Cable transport installation T+O+HB (track + operating + haul-back)

**Cable systems with the track, operating and haul-back (T+O+HB) cables** are **universal** because they are capable of operating uphill, downhill as well as on a flat terrain. Operating and haul-back lines ensure the carriage movement on the skyline, whereas one drum winds and the other is braked off, but slightly braked. The skyline is anchored at both ends and tensioned; the end of the haul-back line is attached firmly on the carriage. It is difficult to get the end of the mainline. It is a trick of riggers to fasten the mainline end to a landing and pull the carriage to stand with mainline braked-off creating thereby a long mainline sling. At the moment when the carriage goes past a linesman, he signals stop of winding-up the haul-back line, and the operator unfastens the mainline from the landing. Then, he begins to wind the mainline that gets on the ground up to the linesman. The operator stops winding-up of the mainline at his instruction and lowers the carriage by releasing the haul-back line to the level of the linesman. He gains thus a sufficiently long free end of mainline for assembling a load.

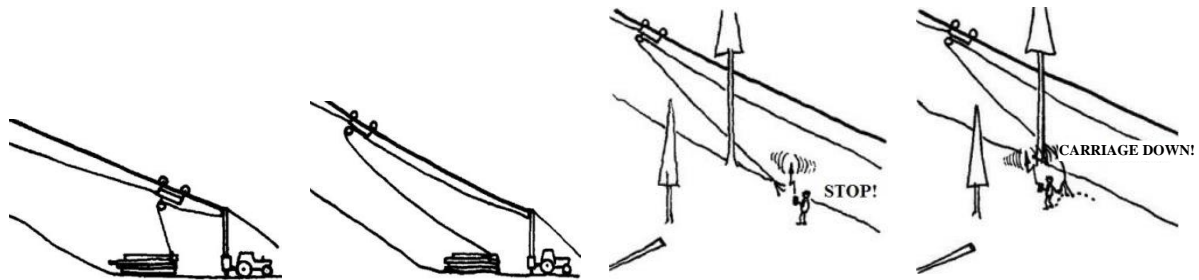

Fig. 41. Obtaining the free cable end

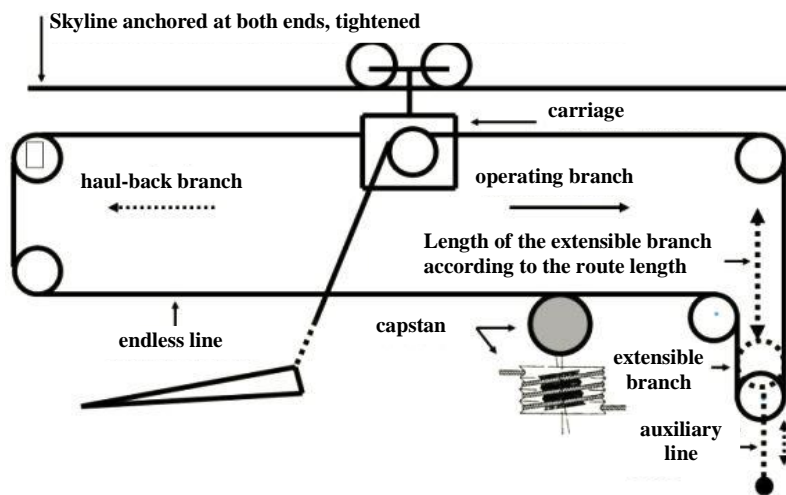

Fig. 42. Three-cable system T+R+A (track + running + auxiliary)

In a **system with the track, running and auxiliary lines**, the skyline is anchored at both ends and tensioned. The carriage which has one end of the running line firmly attached, while the other end of the running line passes through the carriage pulley functioning as a free end of the mainline. The carriage movement is derived from the rotational direction of the capstan. The endless line sling must be shortened by means of variable extensible branch length so that it is possible to pull out the free end of the endless line. At that, the auxiliary line is extended by half of the pulled out free cable. The load is then skidded under the skyline by extending the extensible branch length. – i.e. by pulling the loose part of the endless line inside again. Transport to the landing is done by turning the capstan afterwards. Extension and shortening of cables are coordinated by the computer unit. If it fails, the system operation is impossible. The advantage of cable systems with the endless line lies in their easy operation while the more complex construction (extensible branch) is their disadvantage. The carriage direction is controlled by changing the capstan sense of rotation and final braking of does not exist.

### 3.4 Four-cable installations

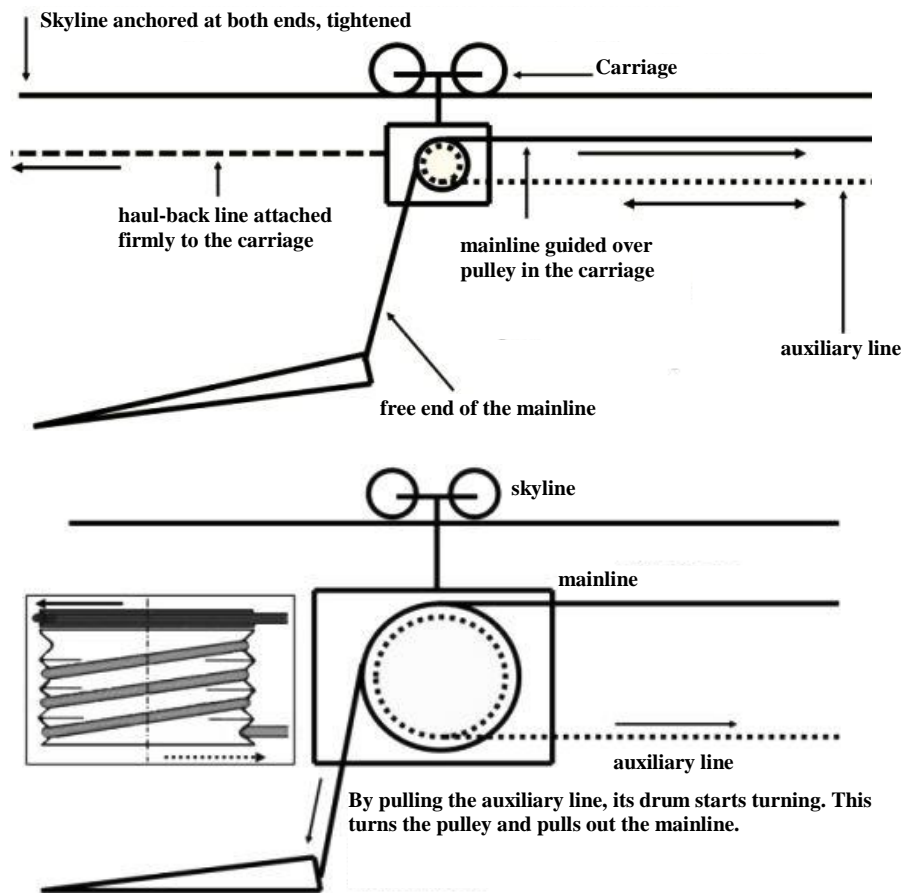

Fig. 43. Four-cable system T+O+HB+A (track + operating + haul-back + auxiliary)

**Four-cable system with track, operating, haul-back and auxiliary lines** work similarly as the T+O+HB system. The skyline is anchored at both ends and tensioned. The carriage runs on it, which has the end of the haul-back line firmly attached at one end. In the carriage. The mainline is guided over the pulley in the carriage, on the axis of which there is also a drum with the auxiliary line. By winding up the auxiliary line, the drum starts turning, carrying the mainline pulley which ejects the free end of the mainline. In the slang of riggers, this is called a forced release of the mainline (also "spitting out"). Working with this system is faster than with the T+O+HB system.

### 3.5 Other ways of cableway classification

#### Route length

The range of length route in the groups can be considered indicative because opinions on borders between the respective groups vary:

- **adaptation (short tractor) cable systems** with a route length up to 150 m
- **short route length CTI** with a route length up to 300 m (500 m)
- **medium route length CTI** with a route length 300-700 m (800 m)
- **long-route CTI** with a route length over 700 m (800 m).

The route length and the number of spans is affected by **topography**. The **terrain** can be **straight**, i.e. with a relatively uniform slope where the number of spans is given mainly by skyline deflection and sag; **"S" shaped** that enables anchoring uphill under certain circumstances, but lowering jacks may be needed; **convex shaped**, in which the number of jacks is given by the number of terrain gradient changes; and **concave shaped** which allows anchoring uphill, too, lowering jacks may be also needed so that the route is not overladen due to load hanging instead of being semi-suspended. In mild concavities, the number of jacks is given mainly by skyline deflection and sag.

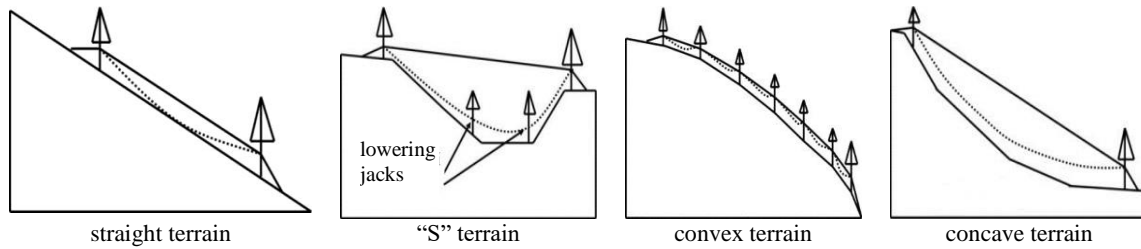

Fig. 44. Terrain shapes

**Skyline height** above the terrain (maintained by jacks) must not be so high that the load dragging in semi-suspension would be changed into the hanging position. The carrying capacity of CTI would be exceeded by that. On the other hand, the skyline must not be led so low that it would touch the terrain surface. A minimum jack height is given by the relation

$$\text{jack height} = \text{deflection} + \text{sag} + 1.5 \text{ m}$$

In designing a CTI, skyline **deflection** due to its own weight as well as skyline **sag** due to carriage and load weight are calculated. Safety height given by the choker length, butt end diameter of hauled log and safety margin are added as a lump sum of 1.5 m.

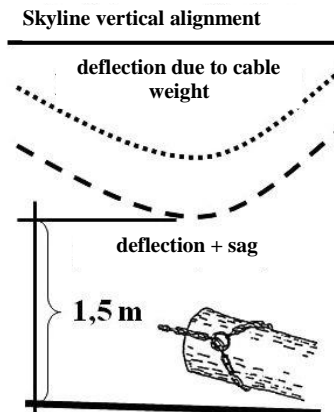

Fig. 45. Rule for minimum jack height (skyline)

### Carrying capacity

The range of carrying capacities in groups is also indicative as opinions about the carrying capacity range of CTIs are inconsistent, too.

- **light-tonnage** up to 1 500 kg (up to 1 000 kg)
- **medium-tonnage** up to 3 000 kg (up to 2 000 kg)
- **high-tonnage** over 2 000 kg, up to 5 000 kg

### Movement of cables (carriage)

- **endless line systems** in which the endless line is set to motion by **capstan** rotation with the direction of the endless line movement changing with the changing sense of capstan rotation. As the radius of cable winding on the drum is constant, the speed of the cable is constant at the constant speed of the capstan. In terms of operation, this is the simplest system in which only the sense of capstan rotation changes.
- **shuttle cable systems** (cycle transport), at which the cable (carriage) movement results from one cable being wound on the drum and the other cable being unwound from the second drum. In CTIs for timber haulage up the hill, the function of the haul-back line can be replaced by gravitation which returns the carriage to the logging site. In view of the fact that the radius of cable winding on the winch drum is variable, the speed of cable winding changes during the winding. In simple carriages, differences between the peripheral speeds of wound and unwound cables are resolved by manual braking of one of the drums. Therefore, the operator must have a view of the whole route and brake by feeling. This causes shocks in the cable and its higher wear as well as the non-uniform movement



of the load and its "jumping" in the simplest carriages without arrest of load height. A technical solution in more advanced and expensive CTIs is recuperation - an interlock system that compensates the disparate cable speeds using different principles (capstans, differentials, hydraulics) without any intervention of the operator.

- **cable transport installations with the motor driven carriage**, in which the carriage moves on the skyline by means of a sling on the free skyline and pulleys set to motion by engine. These CTIs are built as one-span installations (with the effective route length delimited by end-stops on the skyline) and have limited effective weight; this is why they are used for transport of transplants in inaccessible terrain and exceptionally in intermediate felling.

### Type of cable driving equipment

- **winch** corresponds to shuttle cable system
- **capstan** corresponds to **endless line** system

### Sense of transport

- **downhill**, wire and cable chutes making use of gravitation
- **uphill**, a simple two-cable CTI system T+O (track + mainline), O+HB (operating + haul-back line) and one-cable CTIs with motor driven carriage
- **universal**, for haulage downhill as well as uphill and on flat terrains with low bearing capacity, where the carriage cannot be returned using gravitation, O+HB system, three-cable systems, four-cable systems, running systems

### Method of skyline tightening

- **with firmly anchored skyline ends**, where the skyline is firmly anchored at one end and is tensioned manually at the other end by means of tackle and anchored as well.
- **with the skyline (live cable) tightened by motor**, where one cable end is firmly anchored but the other end stays on the winch. Motor driven tightening speeds up the skyline tension by up to 1/3, allows to correct the cable tension during operation as well as fast cable dropping to the ground (for carriage repairs or in emergency situations), and re-tightening. Some CTIs are equipped with a friction, hydraulic or electro-pneumatic safeguarding of permissible skyline load, which excludes its accidental overloading. Some types have an emergency button on the remote control, by pressing of which the tightening drum is braked-off and the cable is released in controlled manner. The skyline is always tightened to the same value calculated by the designer. Winches for motor driven tensioning have two sections. The whole cable length is wound on the storage section and only a part of the cable length needed for tightening moves to the tensioning section through a cut-out in its sidewall. In this section, the cable is wound in one layer only. If the cable length in the tensioning section is not sufficient for cable tightening, the partly tightened cable must be secured with pliers, the cable from the tensioning section is rewound to the storage section and the procedure is repeated. In order to prevent cable deformation, tightening must be carried out on the drum core only.



skyline tightening by manual winch



motor driven cable tightening

**Fig. 46. Skyline tightening**

## Equipment with tower

- **tower systems**, power supply stations of which are equipped with a folding, collapsible or retractable tower; thus, they have the first available support independent of the surrounding stand, which facilitates and speeds up the route construction. Pulleys built in the tower are used as guiding pulleys for winding on drums (without the cable guider). Other pulleys on the tower are for anchoring. The tower height should allow the passage of a truck-and-trailer unit under cables when the CTI is located at the roadside landing.
- **systems without the tower** requiring a mast tree, in case of which it is sometimes difficult to find a location for the power supply station that should be near a suitable mast tree.

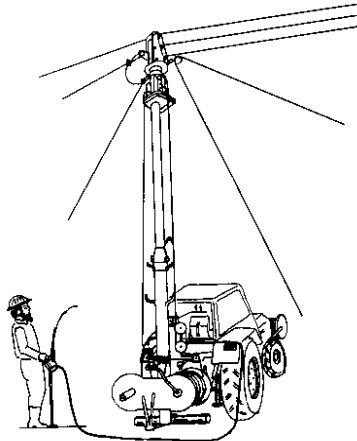
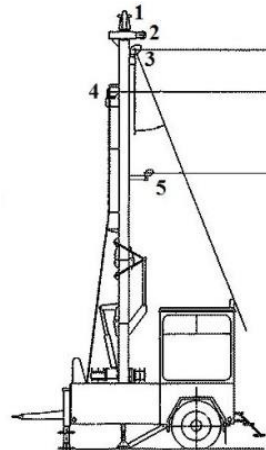

Fig. 47. Tower CTI on 3-point suspension of tractor hydraulics



- 1 skyline pulley
- 2 guy line pulley
- 3 mainline pulley
- 4 haul-back line pulley
- 5 grass line pulley

Fig. 48. Tower CTI on uniaxial chassis

## Chassis type

The type of chassis influences the possibility of constructing a cableway power supply station. CTIs on a vehicle chassis cannot stand anywhere else than on a paved roadside landing; CTIs carried by a tractor can stand on a skidding trail – possibly in the field; CTIs on a sled chassis have the best field accessibility (Wyssen), it can be pulled up using its own cables even to a very difficult terrain.

- CTIs carried on the **three-point suspension of tractor hydraulics**
- CTIs **on a separate chassis** (single-axis, double-axis) drawn by the tractor
- CTIs mounted on the **tractor**
- CTIs **on the forwarder**
- CTIs **on the sled chassis**
- CTIs **self-propelled**
- CTIs **on the vehicle chassis**
- CTIs **on the platform container**

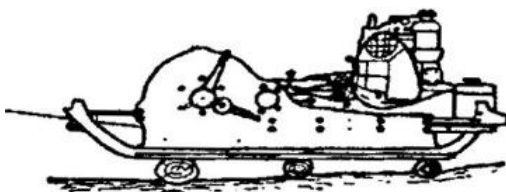

Fig. 49. CTI on the sled chassis

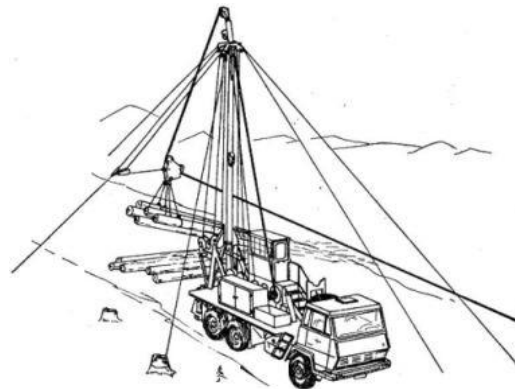

Fig. 50. CTI on the vehicle chassis

## Drive unit actuation

CTIs can be

- powered by the **motor of their own**
- powered by the **PTO shaft** (cardan) from the tractor
- powered by the **motor of basic machine** (tractor, vehicle).

## 4. Main parts of cable transport installations

The power supply station is a subject of delivery just exceptionally, because a functional CTI consists of a **power supply station** or a **power supply unit** (sled winch with a motor, winch powered by cardan from the tractor), **cables** (track, operating, haul-back, running, grass, auxiliary lines), **supports** (natural, semi-artificial, artificial), **cableway carriage**, **accessories**, and auxiliary equipment (e.g. holders of cable drums on the front of general-purpose wheeled tractor for skyline transportation, transport carriages, and caravans). The complete equipment is transported on transport carriages.

CTI accessories include **jacks** (support - raising, lowering; passable jacks and impassable – end jacks), **pulleys** (fixed, opening), **end stops**, **anchor chokers**, **distributors of anchor forces**, **tensioning equipment** (tackles, cable jacks), **protective collars**, **endless textile chokers**, **ladders**, **sets of climbing irons**, **shortening clips**, **signalling equipment** (civil radio stations), **fast-acting clips** and **auxiliary tools**. Sets of climbing irons are used when climbing up trees and simple textile cables from synthetic fibres of 10-16 mm in diameter are used for safeguarding persons. Static cables with elongation 3-5% are used more often than dynamic cables. Fall absorber must be used in any case and at a possible fall, energy has to be distributed so that no part of safeguarding chain is overloaded.

**Winches** differ by

- the number of drums
- the propulsion method (mechanic, hydraulic)
- the brakes of drums winches (band, disk brakes)
- the ways of inducing brake force (mechanic, pneumatic, and hydraulic).

**Capstans** are classified according to propulsion methods (mechanic, hydraulic).

Cables are classified as follows depending on their function

- **skylines** carrying a laden cableway carriage
- **mainlines** drawing a laden carriage on the skyline; in systems without the skyline, they draw the load
- **haul-back lines** returning an empty carriage to the logging site on the skyline; in systems without the skyline, they return the mainline to the logging site over a pulley
- **grass lines** serving the purpose of system construction, i.e. cables for anchoring supports, for tensioning and anchoring the skyline, for hanging jacks, for retracting cables to stand during the assembly
- **auxiliary lines** for ejecting the free end of the operating (running) cable from the carriage
- **endless lines** functioning as operating as well as haul-back lines in CTIs with the endless line.

**Supports** hold the skyline at a required height over the ground. The first and last supports are called **end supports**.

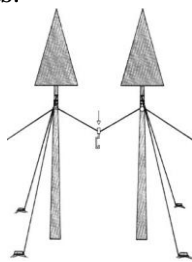

Fig. 51. Suspension of jack on the natural “M” support

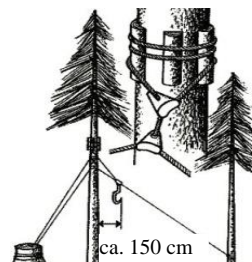
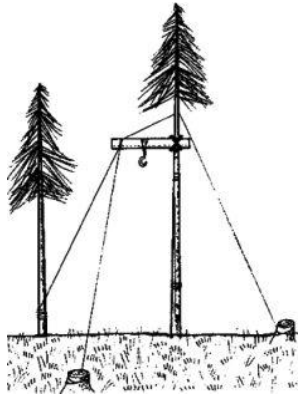

Fig. 52. One-sided natural support

- **natural supports** are sufficiently sized **support trees** in the close proximity of route. If they carry an impassable jack, they are **mast trees**. Jacks are hung on supports by means of cables in such a way that the cable with the jack and trees create an “M” shape. An ideal angle of cable deflection at the top of “M” is 60-100°.
- **semi-artificial supports** are supports of trees that must be reinforced; or there is just one tree near the route and the function of the other tree is substituted artificially; or the support tree has to be inclined after its previous partial cutting and anchoring.
- **artificial supports** are laborious and costly; this is why they are used in extreme cases only.



3

Fig. 53. Semi-artificial supports

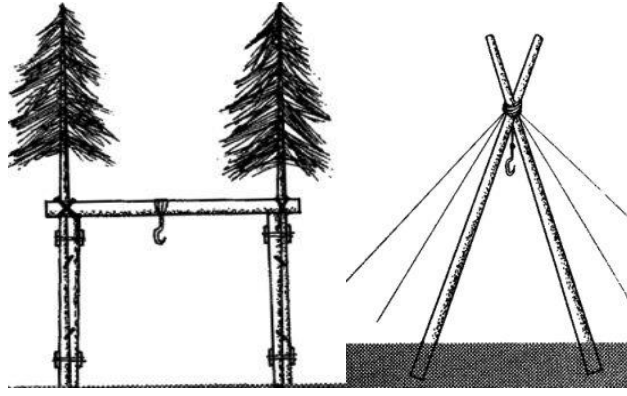

Fig. 54. Artificial supports

The height of hook or pulley suspension for the suspension of jack is governed by the 2:1 rule; i.e. the jack suspension cable is to be placed on a tree 1 m above the skyline per two meters of distance between the jack tree and the skyline axis. The final jack height is adjusted then by tightening the jack cable. At that, it is necessary to respect the scheme of the distribution of forces from the skyline onto the jack cable so that its overloading is avoided. If the deflection point angle on the jack has reached 90-100°, it is necessary to hang the jack to a greater height. At suspension on two trees, the assembly time is significantly extended.

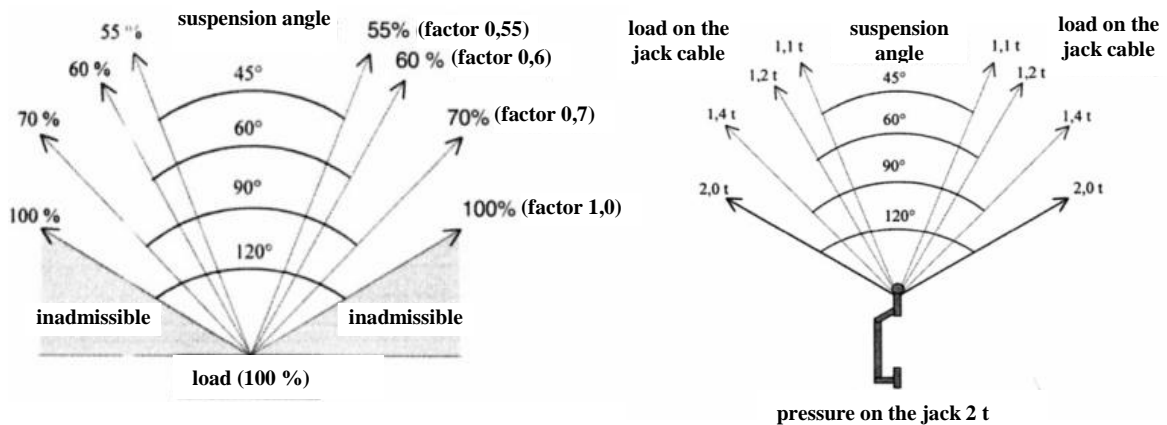

Fig. 55. Distribution of jack load onto jack cables

#### 4.1 Cables, chains and chokers

Cables are made of various materials - steel, artificial fibres, hemp etc. **Steel cables** are used most frequently. Steel cable is a very articulated machine element from the given number of bare or zinc plated steel wires twisted in bundles of uniform diameter – strands – that are stranded into cables.

##### Basic structural properties of cables

- Cables can be stressed only by pull and bend

- steel cables have a high carrying capacity and small diameters compared to cables from other materials
- flexibility and capability of being wound on drums and passing over pulleys
- relatively low weight
- good abrasion resistance
- capability of extension, splicing, termination, etc.

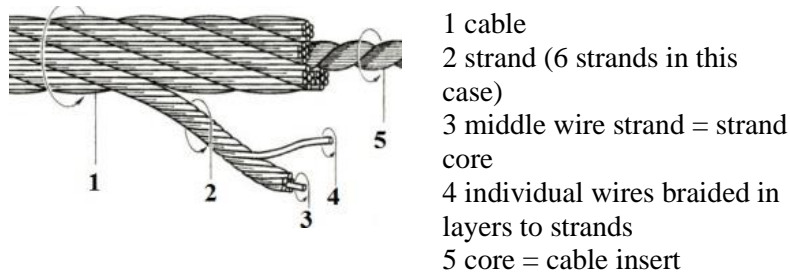

Fig. 56. Basic parts of cable

### Basic structural properties of cables

- **material**
  - steel of 1270, 1570 and 1770 MPa nominal strength (but also 1960 and 2160 MPa for skylines and guy lines of cable transport installations), steel cables are made of special cold profiled wires, of circular cross-section usually, the wires are either bare or zinc plated
  - hemp (natural materials)
  - artificial fibres.
- **purpose and area of application (skylines, mainlines, guy lines, grass cables, auxiliary lines, steering cables, etc.)**
- **structure** (the way of winding and arranging wires and strands, number of strands, number of wires, nominal cable diameter, nominal diameter of wires, etc.)
- **surface treatment (bare, zinc plated, semi-closed, closed, rolled)**
- **rolled strands and rolled cables;** cables compacted by rolling individual strands or whole cables are stronger with their cross-section being smaller than in common cables. The smooth rolled surface increases the service life of cables thanks to lower abrasion, and the lower friction on the soil makes the load dragging easier.
- **adjustment of internal stress** (non-deadened, deadened)
- **strength characteristics** (nominal strength MPa, allowable loading kN)
- **number of strands** (most frequently six-strand cables)
  - one-strand cables
  - multi-strand cables
  - cable lines (twisting several cables)
- **design** (most often standard design)
  - twisted cables – rigid twisting cables, without core, they are not used in the forestry practice because they require pulleys and cable drums of large dimensions, they cannot be braided – jointing is possible using pressed couplers only
  - standard - all wires of the same cross-section
  - Seal - there are wires of the same diameter in each layer while diameters in different layers differ (the external layer consists of larger-diameter wires). Each layer has the same number of wires and thus also the same height of stranding so that wires of the external layer fit well into the furrow of the internal layer. The contact area between wires of both layers is greater than in case of cables of standard design, therefore the specific pressure is smaller and the cable durability is higher. It is more resistant to abrasion compared to Warrington cables.
  - Warrington - the contact area between the wires of neighbouring layers is larger, thin and strong wires alternate in the second layer. They are more flexible than Seal.
  - Warrington-Seal – is a combination of the two designs. Strands have more wire layers; external wires have a larger diameter. They are very flexible and resistant to abrasion.

- Filler – the space between the large-diameter wires of internal layers is filled with low-diameter wires.
  - **cable core (insert)** improves cable flexibility and lubrication. It can be a **textile core** ( hemp, synthetic fibres) which is lighter than the steel one, and this is why cables with textile cores are suitable as binding, guy, and suspension lines; **compact plastic core** from fibres closed in the plastic has a lower elongation at break than the textile core; cables with such core are suitable as mainlines of long-route cable transport installations; **steel core** consists of one single steel strand or cable; cables with a steel core are crush resistant and have a strength by 15-20 % higher than cables with the textile core; they are used where high strength at a limited capacity of drums is required – i.e. as mainlines of tractor winches and operating and haul-back lines of cable transport installations; **steel core with plastic** indicates that the steel core is closed in a polypropylene packaging, by which the spatial placement of the core and external strands is fixed. In cable samples, the core is designated with capital letters: FC - textile insert (NF natural fibre, SF synthetic fibre), SC - steel core (W central wire, WS strand, WR cable).
  - **internal stress in cables** causes their twisting. Cables relieved of internal stress (**deadened cables**) are not inclined to twisting after having been unrolled. Cable deadening can be made by the supplier to order or achieved by multiple pulling through a set of pulleys.
  - **factor of cable filling** is a ratio between the supporting cable cross-section and circular area related to the cable diameter. It varies within a range of 0.5-0.8.
  - **openness of cables**
    - open cables – made of wires of circular cross-section only (most common in forestry)
    - semi-closed cables
    - closed cables
- External layers of semi-closed and closed design cables have the outer layer formed by alternating wires of circular cross-section and profile wires that fit together well and prevent water to enter the cable. They are used as guy lines or skylines in cable cranes and cable transport installations.
- **direction of cable winding** – clockwise and counter-clockwise. Connected can be only cables with the same winding direction. If cables of unequal direction of winding are connected, the shorter or thinner cable becomes untangled by pulling. The selection of cable winding direction depends on the design of drum winch – the cable is led to it from above or from below, the place of cable fastening in the drum – right or left, and the sense of cable winding onto the drum – from left to right or from right to left.
  - **way of cable winding, Lang lay cable** – directions of winding wires in strands and strands in the cable are identical; cables are more flexible, more resistant to wear, they make loops, and may be only under a small permanent tension to prevent their untangling; **ordinary lay cables** – directions of winding wires in strands and strands in the cable are opposite (cables are more rigid, they wind well, untangle less); **parallel cables** from wires of different diameters (Seal), wires do not cross, contact area is large; **regular-lay cables** have wires in the strand wound in the opposite direction than the strand – they are crossed, they have a better resistance to twisting, but a lower service life. Only cables with the same strand winding length in the cable can be braided.
  - **differentiation of cables according to their use**
    - moving cables (mainlines of lifts, cableways, winches) must be properly flexible
    - stationary cables (guy cables, skylines of cable cranes) can have lower flexibility

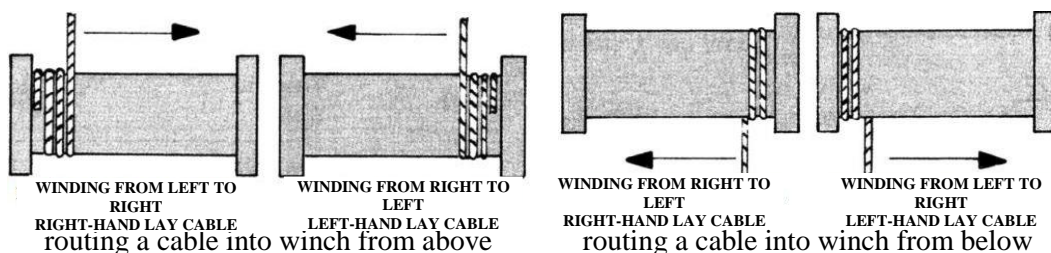
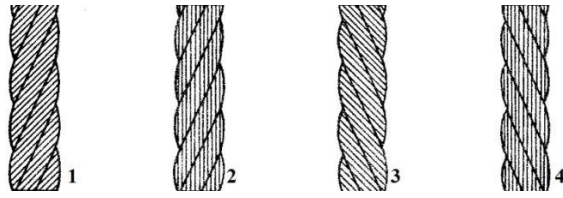

Fig. 57. Selecting direction of cable winding according to winch design

The **measurement of cable diameter** is carried out using a sliding gauge with wide jaws in two points of cable distant from each other 1 m in two planes that are perpendicular to each other. Mean value of these 4 measurements gives the cable diameter. Allowable diameter tolerance of a new cable that has not been stretched by operation yet is only of plus character, in cables over 8 mm in diameter ranging from +4 to +1 %.



1 right-wound Lang lay, 2 right-wound ordinary lay,  
3 left-wound Lang lay, 4 left-wound ordinary lay

**Fig. 58. Ways of cable winding**

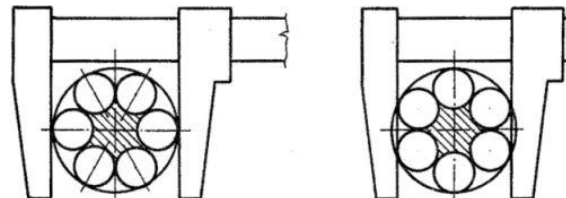

correct wrong

**Fig. 59. Measurement of nominal cable diameter**

The **capacity of the winch drum** can be a limiting factor at skidding timber over long distances (on soils of low bearing capacity, in areas of natural regeneration, from ravines, over a water course etc.) and a limiting factor at adapting the tractor winch to a short cable system. In general, more expensive cables of smaller diameters are preferred in cable transport installations which maintain good carrying capacity.

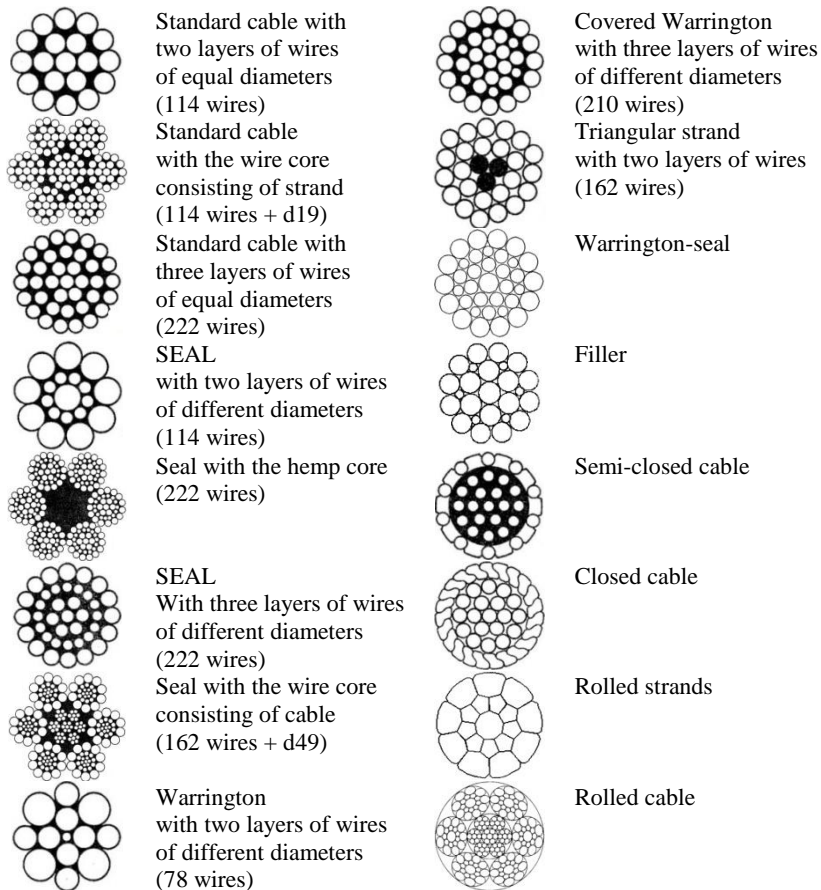

**Fig. 61. Examples of cable design**

**Numerical designation** (formula) of cable design: digit before the bracket = number of strands. Quantities of wires in individual layers are specified in brackets, v letter after the brackets = textile core (wire core – d letter with the number of wires in the core, e.g. +d19).

$$6 (1+9+9) + v$$

$$6 (1+9+9) + d14$$

Cable type	Technical standard	Number of wires (usual number)	Cable design (cable formula)
standard six-strand	ČSN 02 4322	114	6 (1+6+12) + in
standard six-strand	ČSN 02 4324	222	6 (1+6+12+18) + in
Seal six-strand	ČSN 02 4340	114	6 (1+9+9) + in
Seal six-strand	ČSN 02 4342	162	6 (1+6+10+10) + in
Seal six-strand	ČSN 02 4344	222	6 (1+6+15+15) + in
Seal six-strand	ČSN 02 4346	330	6 (1+6+12+18+18) + in
Warrington six-strand	ČSN 02 4348	210	6 (1+6+ (6+6) +16) + in

Table 3. Commonly used cables

**Structural parameters of steel cables** are important for cable users who define basic cable application properties according to them

- formula of cable
- nominal weight of cable  $m$  [kg.m<sup>-1</sup>] – weight of 1 m of cable
- nominal strength of wires  $\sigma_i$  [MPa] – the smallest guaranteed tensile strength of wires
- nominal diameter of cable  $D$  [m] – diameter of circle circumscribed around the cable
- carrying cable cross-section  $S$  [m<sup>2</sup>] – the sum of cross-sections of individual wires
- nominal carrying capacity of cable  $F_{max}$  [N] – cable loading at its ultimate strength, the product of nominal strength of wires and carrying cable cross-section
- allowable cable loading  $F_{dov}$  [N] – force by which the cable can be laden safely depends on the level of safety expressed by the coefficient of safety  $k$  (*cables of tractor winches 2–3, cables of forest cableways 3–5*)
- required cable properties (specified in the order) are represented by the number of CSN with ciphers specifying the material and surface treatment, cable diameter and length; common values of nominal diameters for cables of tractor winches are within the range of 10–14 mm.

Diameter of cable mm	Weight of 1 m of cable kg	Carrying capacity of cable (kN) at nominal strength (MPa)	
		1570	1770
8	0.25	39.6	44.6
10	0.37	63.5	71.6
12	0.54	87.0	98.1
14	0.73	124.5	140.3
18	1.16	197.0	222.1

Table 4. Example of Seal cable diameter, weight, and carrying capacity parameters

**Interconnection of cables** is a great advantage of this machine element since it is possible to select (permanently or temporarily) the cable length as needed optimally, possibly to connect the cable again after its breakage or to connect its remaining parts again after cutting out a damaged or excessively worn cable segment. Only cables with the identical direction of winding can be connected. If cables with the unequal direction of winding are connected, the shorter or lower-diameter cable untangles due to tension. Connecting cables using only spliced eyes or a ring only is inappropriate because the cables would “cut off” each other due to the cable pull. A method popular in the forest practice is tying two cables using a weaver’s knot, into which a log is inserted so that the cables are bent over the largest possible radius. Only cables with the same strand winding length in the cable can be spliced.

Connecting cables using either short splicing (similar to termination, cable diameter in the joint increases, splicing length min. 40 d, i.e. threading each strand through min. 4 times) or long splicing (cable diameter in splicing does not change, splicing length is min. 1000 d, example: cable Ø 10 mm, splicing length 10 m, is spliced from ½ of strands number only, removed strands replace each other in the opposite cable part)



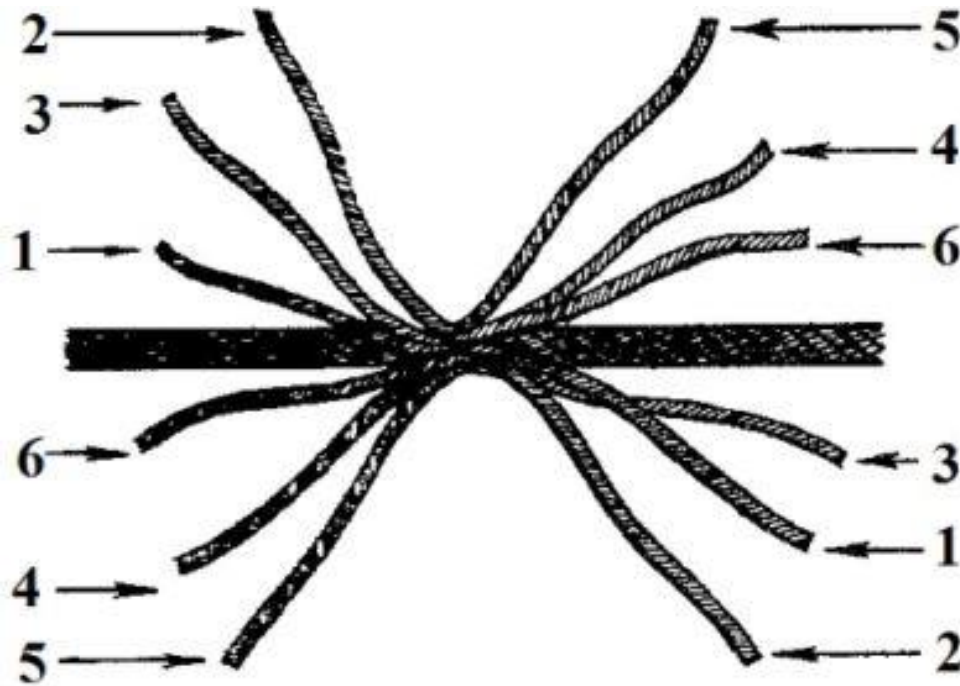

Fig. 62. Connecting cables by splicing

		by flat clamps
		by entwined eyes (not appropriate)
		by rings (coupler) (not appropriate)
		by extending end-pieces ("c- pieces")
		using weaver's knot with inserted log

Fig. 63. Connecting cables – other methods

**Cable terminating** is a modification of cable end using pressed end-pieces, conical end-pieces or an eye. When using cable clamps (often referred to as "blajchrtyky" in operating jargon), individual clamps are fastened to the cable at a spacing equal to at least clamp width and 3-8 of them are used on cables of normal diameters (4-5 must be on the most often used cables of 11-13 mm in diameter and they must be tightened by torque of 33 Nm). Clamps must be tightened again after a short operation period at full load. If clamps are used to connect cables – a full number of clamps must be on each side of a joint, which means that as compared with the cable termination, cable extension requires a double number of

clamps. Clamp strap should be on the side of cable end. In extending cables of different diameters, clamps for a larger diameter are used and the lower-diameter cable is folded as many times as to fill in the clamp space.

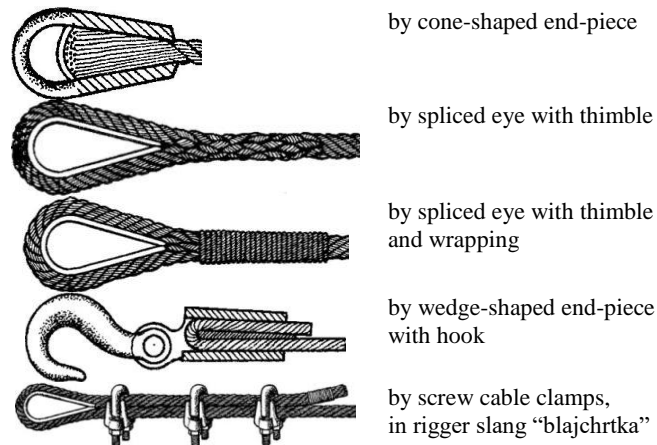

Fig. 64. Methods of terminating cables



clamp strap is always at the side of cable end, the full number of clamps is on each side

Fig. 65. Connecting cables using screw cable couplers

**Dividing and shortening of cables** is carried out in the workshop by burning with the burner or by cutting with the cutter, in the field then most often by using a chisel and hammer. Prior to dividing a cable, it is necessary to wrap the point of division on both sides with the wire to prevent spontaneous untangling of strands. A common binding wire of 1.5-2.0 mm in diameter is used for wrapping, the bandage is tightened as firmly as possible, the length of wrapping is at least three times the cable diameter, and the wrapping begins at all time from the future cable end.

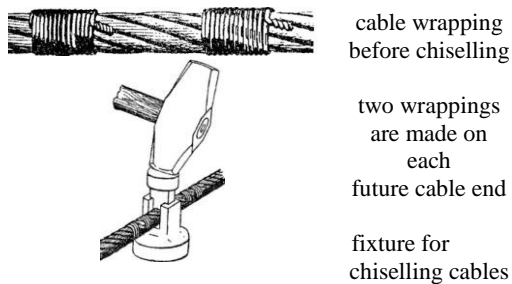

Fig. 66. Cable chiselling in the field

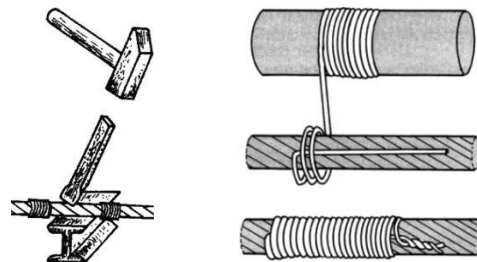

Fig. 67. Wrapping procedure

### Care of steel cables

- regular cleaning and lubrication with a suitable oil to decrease friction and to prevent moisture entering into the cable. Regular lubrication of cables can extend their service life by up to 1/3. The rope core is saturated with lubricating grease during cable manufacturing so that the grease is pushed through from the cable core to middle layers due to cable loading. Greasy, sticky layer should not stay on the cable surface after lubrication because it can influence the function of self-locking jaws of the tensioning equipment of cable transport installations.
- storage in dry areas wound on spools (min. spool diameter = 40 times cable diameter)
- turn cables occasionally if they are stored on spools for a longer time so that preservative grease does not drip down from them but stays inside the cables
- unwind cable properly and prevent looping
- minimize cable "breaking" due to sharp bends and limit its contact with hard objects (stones) when pulled.

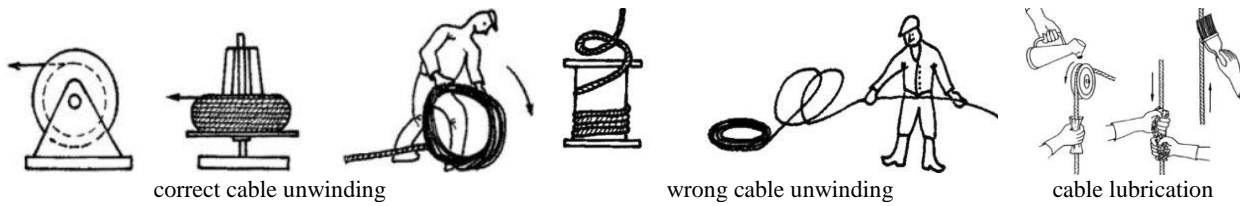

Fig. 68. Care of cables

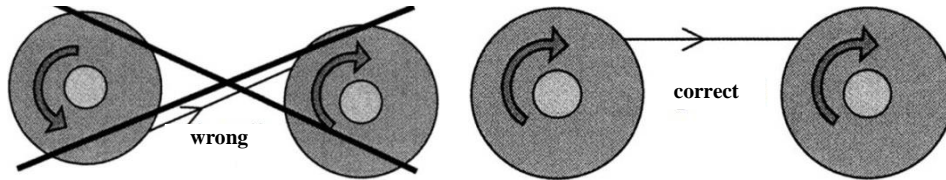

Fig. 69. Wrong and correct cable rewinding from drum to drum

**Symptoms of cable damages leading to their discarding** consist in a strand rupture, reduction of nominal diameter by more than 15% of nominal diameter, wear of external wires by more than ½ their cross-section, rupture of more than 15% of visible wires in one lay length, strong deformation (flattening to elliptical cross section) or loosening of cable strands, knot or loop, cable fracture, strong corrosion, conspicuous cable extension, blue colouration due to hardening.



Fig. 70. Some damages of cables leading to their discarding

**Chokers** are used for binding the load (tree, stem, log) and its fastening to the mainline of winch (splinter bar at yarding timber by horses). **Cable** and **chain chokers** are used for dragging timber, **textile chokers** are used for gentle attachment of corner blocks to standing trees.

**Cable chokers** are suitable under conditions when the choker is tensioned permanently so that it does not loosen and slip off the stem. Permanent tension of chokers is best ensured by skidding in semi-suspension or uphill under favourable field conditions (chokers get loose when the load hits obstacles), on non-abrasive subgrades and at short-range dragging. They are made of six-strand cables with strength characteristics similar to cables of winches. Choker length of 1 m will be sufficient for thinning; a length of 1.5-2.0 m is used for main felling. There is usually a hook, a sliding hook, or a cylindrical sleeve at one choker end; at the other end, there is an entwined eye, metal eye etc. to make a self-locking loop for fastening the. Chokers with the cylindrical sleeve have a glide slid on, into which the sleeve is inserted. They are used in the method of choker line.

Number of holding wires in cable external layer (without wires of filling)	Number of visible wire breaks			
	regular-lay		Lang lay	
	in 6 d length	in 30 d length	in 6 d length	in 30 d length
up to 50	4	8	2	4
51 - 75	6	12	3	6
76 - 100	8	16	4	8
101 - 120	10	19	5	10
121 - 140	11	22	6	11
141 - 160	13	26	6	13
161 - 180	14	29	7	14
181 - 200	16	32	8	16
201 - 220	18	35	9	18
221 - 240	19	38	10	19

241 - 260	21	42	10	21
261 - 280	22	45	11	22
281 - 300	24	48	12	24
more than 300	0.08 n	0.16 n	0.04 n	0.08 n

6 d = six times cable diameter, 30 d = thirty times cable diameter, n = number of holding wires in external cable layer  
According to FRAUENHOLZ, 2008

**Table 5. Some damages of cables leading to discarding**

**Chain chokers** are heavier compared to cable chokers; however, they are applicable in stony terrains, on routes with reverse slopes (they do not tend to loosening) and at longer distances. They are made of link chains from standard, high strength, abrasion resistant, alloy and heat-treated steels. The strength characteristic of a high strength chain is in the order of 50 kN, safety coefficient is 2. A circular shape of eye material cross-section is most often used in our conditions. an angular (square) shape is used, too, which has strength increased by 8 - 9 %, a significantly better grip of the stem, higher abrasion resistance, higher service life and puts a little more resistance only at timber dragging. There is an eye at one chain choker end and there is a hook or a profiled eye at the other end that is narrowed to the chain width at least at one end. The profiled eye is usually slid also on the end eye. The length/weight of chokers is 1.6 m/3.5 kg; 2.0 m/4.2 kg; 2.5 m/5.1 kg. The tight stem grip is the advantage of chain chokers (with inserting the chain link to the profiled eye so that the choker cannot slip even when the tension is released), they can be shortened easily when a profiled eye or an opening on the sulky or on tractor are used; the shape of chain links allows for high chain extensibility (chain extension at overloading) and warns operators against approaching rupture, some chain kinds display extensibility of 20% (elongation by 20 cm per 1 m length), and chain chokers act as a brake at skidding downhill.

Nominal link diameter (mm)	Link width (mm)	Weight (kg/m)	Carrying capacity (kN)
6	20.0	0.74	13.3
7	23.0	1.00	18.2
8	26.5	1.30	23.9
9	30.0	1.65	30.2
10	33.0	2.00	37.3

**Table 6. Parameters of standard chains for chokers**

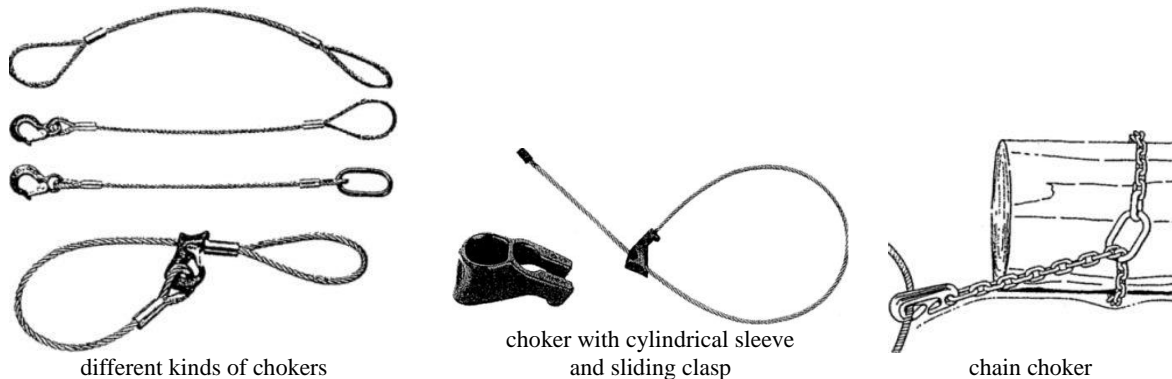

**Fig. 71. Chokers**

**Textile chokers** are made of an endless bundle of high-strength polyester or another fibre laid in the protective enclosure. They are light, have a high carrying capacity and a wide range of thermal use (-40 to +100 °C); they protect the surface of tree, to which they are fastened; they are delivered in endless design or with eyes; the basic carrying capacity is 500 - 30 000 kg and it can be increased by the method of binding (simple, to a sling, parallel – twin); the length of endless choker = circumference, commonly supplied lengths are 1.0 m, 2.0 m, 3.0 m to 20 m; the carrying capacity for chokers is shown in colour and by inscription on the choker packaging; they are suitable for fastening pulleys and guy lines of cable transport installations to trees; they are not suitable as chokers for dragging timber!

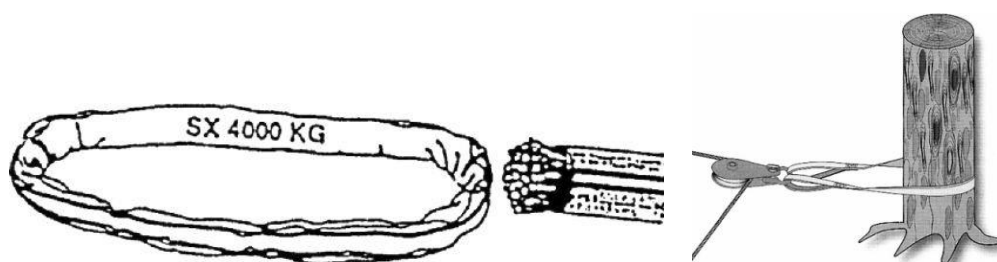

Fig. 72. Textile choker and its use at tying corner block to tree

Nominal carrying capacity in tonnes	Ways of choker tying		
	straight	sling	parallel
1	1	0.8	2
2	2	1.6	4
5	5	4	10
8	8	6.4	16

Table 7. Allowable loading of textile chokers in different methods of tying

**Textile cables** (from hemp and artificial fibres) are not wound to drums usually; they are folded to scrolls – see Fig. No. 16.96.



Fig. 73. Procedure of folding textile cables to scrolls

## 5. Work technique at timber yarding by means of CTIs

Timber yarding by means of CTIs is applied mainly in felling on steep slopes with obstacles. It is still underestimated in flat terrains on soils with the low bearing capacity and generally in the improvement felling. While valley roads are suitable for yarding timber by horses and tractors because the transport takes place downhill, yarding timber using CTIs is more appropriate uphill for a number of reasons, to which ridge and contour roads correspond logically. The spacing of roads of approx. 800 m suits well because the space between them can be covered by short-route and medium-route CTIs at alternative timber yarding uphill and downhill enabled by universal CTIs. Working fields are usually situated alternately against each other, one time downhill, and the other time uphill, with one field being left out to prevent clearcut area. A working field width up to 60 m (80 m exceptionally) is suitable. The route length depends on the CTI type. It is reasonable to distribute the slope length to two working fields also in order to limit the risk of water erosion. The catchment area is smaller and on a shorter slope the surface water might not achieve carrying speed.

As at uphill yarding the transported timber is constantly under control, does not move spontaneously and “astray” behind trees standing next to the route as it happens at downhill transport, it should be given priority. However, this requires a change of the whole transport solution. While the timber transport was designed exclusively as gravity cable logging with the use of valley roads at snubbing and skidding by animals, **using contour slope roads** is more suitable for anti-gravity timber yarding by means of CTIs. In mountain areas, slopes are made accessible most appropriately by running a contour slope road below the slope ridge where a steep slope falling into the valley passes into the slope top of gentler gradient that can be managed by tractor technologies of timber yarding. This is why a transition to cableway technologies of timber yarding requires a fundamental **change of forest transport**

**network.** The uphill timber yarding by CTIs is advantageous also in terms of acquisition costs and easier operation because CTIs capable of uphill transport only can be just of two-cable (skyline and mainline) design. This has a positive effect on their lower purchasing costs and assembly speed. Even the operation of such an equipment is substantially easier than the three-cable systems (requiring to slow down the released drum of haul-back line simultaneously with winding-up the mainline). The uphill timber yarding is also **more environment friendly** than the downhill yarding because with the same affected area, rills developed by sliding load ends on the ground fork to infiltration, while in the downhill yarding they converge under the skyline, thus creating preconditions for a concentrated surface runoff of rainwater. In forest road location and construction, all plateaus and places of lower gradient should be used for establishing landings and spaces for CTI power supply stations. Later establishment of such spaces disrupts the road body and is more expensive. It is advantageous to lead the roads on the verge between the “tractor and cableway terrains” and thus to make use of tablelands and floodplains for tractor yarding and to make steep slopes accessible using only the CTIs. This principle (economically conditioned) does not apply in water management areas and in terrains of low bearing capacity.

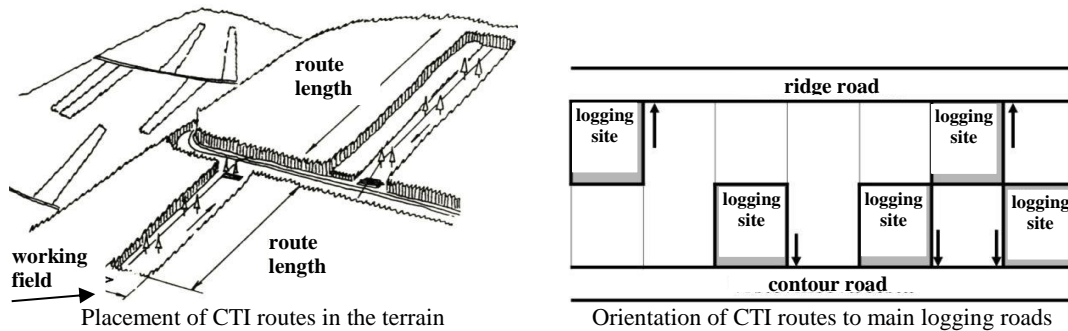

Fig. 74. Examples of CTIs routes

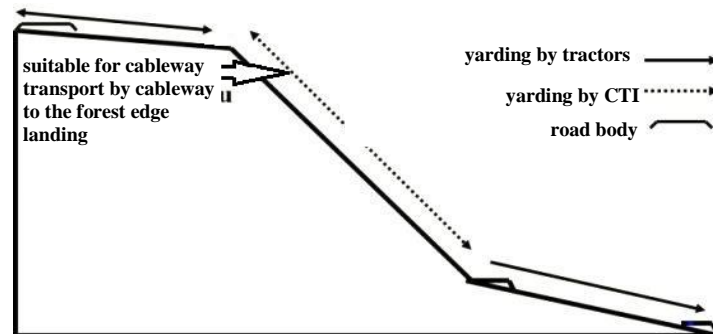
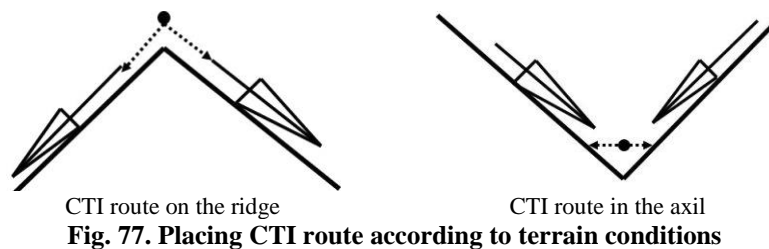
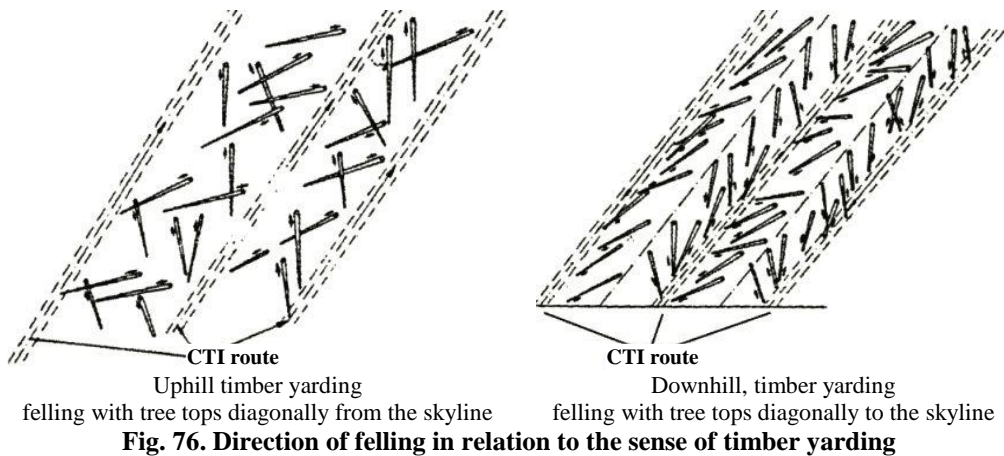

Fig. 75. Placement of logging roads on terrain faults and the corresponding technologies of timber yarding

The sense of transport decides on the **direction of felling**. Although the felling is done downhill in both cases due to occupational safety, at yarding the timber uphill, tips point from the skyline so that rhizomes are directed diagonally to it, while at yarding the timber downhill, the felling is done with tips pointing to the skyline. If the timber is yarded parallel to harvesting, there is a danger that a tree top may hit the skyline because sometimes even an experienced wood cutter does not estimate the tree height properly. In rugged terrains, CTI routes cannot be placed schematically but it is necessary to follow the relief. If a harvesting operation is placed on both sides of ridge, we place the route on the ridge line (not to have to bring the mainline uphill). If the ridge line is not suitable for CTI construction (boulders, low trees), there is no choice but the place the route through the axil. Trees usually “slide down” to it after felling by themselves or they are snubbed over a short distance and it is not necessary to bring the mainline far uphill. The route can be located in the axil too, if the timber is skidded by horses towards the skyline.



In view of the fact that CTI is a linear structure, a longitudinally oriented strip with a working field width of 60-80 m is the most suitable shape of the workplace in terms of its effective use. In forestry terms, it is therefore strip clear felling or strip shelterwood felling. As to technology, clear felling is logically the least demanding and allows the highest timber concentration to be felled for one route. A theorem still applies for acceptable economy of cableway timber yarding that at least 1 m<sup>3</sup> of volume felled should fall to 1 m of skyline length. Selective felling requires carriages that can be arrested at any place of the route so that stems are skidded towards the skyline in the ideal direction and at the same angle along the entire length of skidding or that it is possible to change the angle of skidding during the timber movement, if needed. Skidding perpendicular to the skyline is inappropriate because it overloads the skyline. At **strip felling**, the working field width usually equals the width of strip and the CTI route is located in the longitudinal strip axis. In the **felling by the wedge system**, which is characterised on the slopes by wedges cut out in the stand margin, with a base of 20 – 40 m and a length equal to one or two bases with the tip pointing downhill, the procedure of skyline timber yarding is similar as in the strip felling – the CTI route is located in the wedge axis.

The placement of felling measures by the forest manager (organizer) should allow route construction not only in the current decade but also in the next one. It means that groups of trees should be left on the sides of roads so that a route can be anchored in the coming years or at felling in the neighbouring stand. Regeneration measures should be principally placed so that their narrower side is adjacent to a logging road or a slope road. It is inappropriate to place these measures parallel to roads because it would require the construction of more routes. Operations at right angles to the contour are most frequent, although the oblique downhill skidding or exceptionally also the skidding along the contour is possible using CTI. However, in such a case and at greater transverse gradients, the dragged timber rolls sideways, the cableway carriage snags on the jack when passing it (at multi-span CTIs), and trees standing on the lower route edge must be protected by fenders. In these cases, the CTI route is not in the middle of strip width but approximately in its upper third so that the mainline is retracted downwards for a larger part of timber.

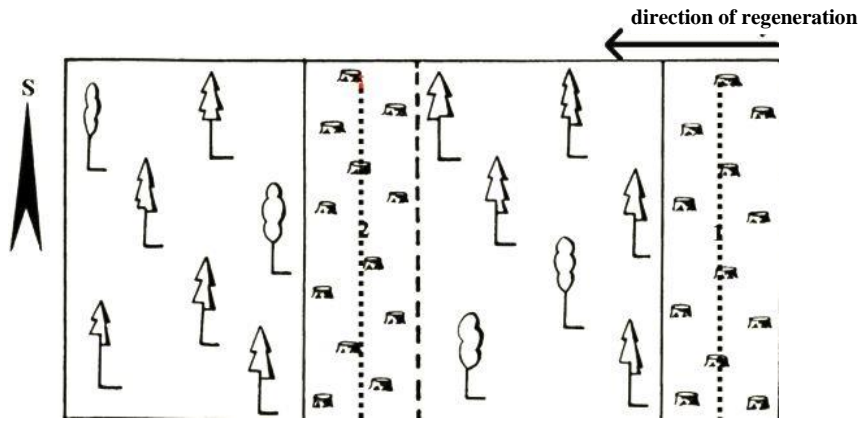

Fig. 78. Strip felling

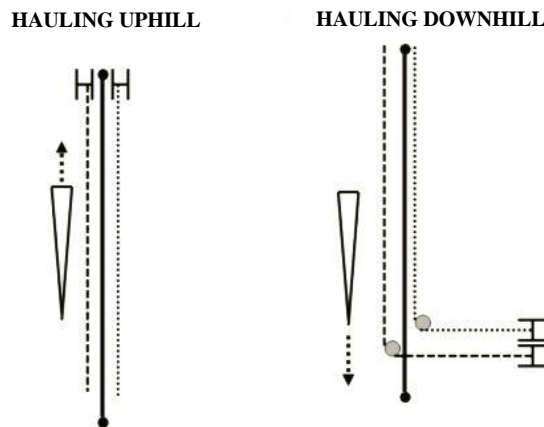

Fig. 79. Location of CTI power supply station in dependence on the sense of timber haulage

If there is a choice, skidding **uphill** is more expedient because the cheapest CTI types with track and mainlines can be used, there is one cable less in the route construction as “there is nothing to brake” at winding-up the mainline, the power supply station can stand in the skyline axis (advantageous in tower systems), cables are retracted downhill in building the route, the carriage returns by gravitation to the stand and the load is permanently under control at yarding timber uphill. Hauling timber **downhill**, it is difficult to maintain the load in semi-suspension (it falls down), the load gets running spontaneously, its final braking is more difficult, the load can “stray” behind the standing trees and it is hard to free it using reverse gear and the power supply station must not stand in the skyline axis (because of safety). The risk of spontaneous timber movement can be reduced effectively by yarding whole trees!

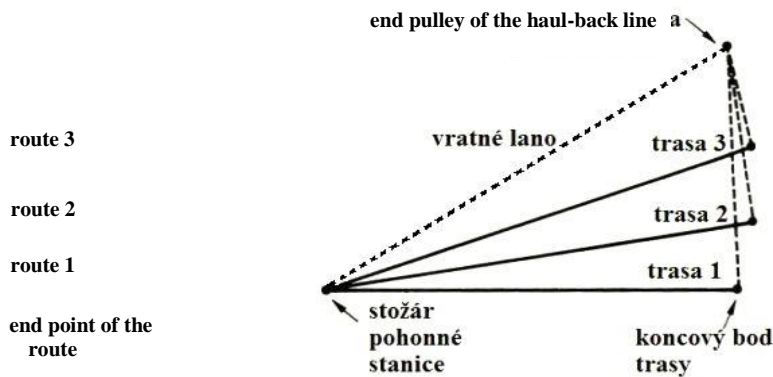

Fig. 80. Fan-like route reconstruction

It should be noted that not all CTI types are suitable for the selective harvesting. To prevent damage to standing trees by timber yarded under the skyline, it is necessary that the angle of timber skidding does



not change from the moment of skidding start up to skidding under the skyline. This can be ensured only by such CTIs or such cableway carriages that can be safely fixed during the whole time of skidding in a single point of the route. It should be also noted that the angle of skidding under the skyline should not exceed  $45^\circ$  because at a greater angle, the permitted skyline stress may be exceeded due to the distribution of forces acting in the mainline.

Each reconstruction of CTI route is laborious and strenuous. Unfortunately, in conditions of Czech Republic, the haul-back branch can be left in place and the route can be carried over in a fan-like manner only under certain circumstances (in areas affected by natural disasters). Internationally, this procedure is common in extensive felling.

### 5.1 Ways of unloading timber at CTI

- **under the skyline**
  - **without turning the load**
  - **with turning the load in the direction of haulage**
- **with pushing (pulling) away from the skyline**

**Unloading under the skyline without turning the load** can be used, if the CTI route follows the road in parallel (in the turning point) and there is enough space to deck timber at one landing or more landings. Continual haulage is necessary because CTI is out of operation when the vehicle is being loaded. Another possibility is when the CTI route crosses the road at a sufficient height which allows the passage of trucks and working with the hydraulic crane. In such a case, timber is placed below the road in perpendicular direction thereto so that butt ends are within the reach of the loading device. On the lower landing edge, logs must be placed transversally so that timber does not slip downhill. If the terrain and the cable height allow timber unloading even above the landing, a similar method is used, only the timber is placed with small ends pointing towards the road. **Unloading under the skyline with turning the load in the direction of haulage** can be used, when the CTI route cuts the road but the load has to be turned to the direction parallel with it. If the terrain allows, timber is decked below as well as above the road. A transverse log must be placed below the road to prevent the load slipping downhill when the winding-up is stopped. As soon as the log small end overcomes the transverse log, the winding-up stops and a skidded log which is in a labile position (leaning on the ground with the small end and having the butt end suspended on the mainline) is guided to the direction of unloading using a pole (hookaroon) and the load is then braked-off. To prevent its rolling down the hill, the landing must be situated behind the standing trees. Continual haulage is necessary because CTI is out of operation when the vehicle is being loaded. **Unloading with pushing (pulling) away from the skyline** is used in full tree harvesting most often when delimiting follows after the tree removal. The yarding capacity is higher compared to the above-described ways. Continual haulage is not necessary because the CTI operation is not restricted during the loading. However, the costs of means removing the timber (hydraulic crane or tractor) increase the costs of timber yarding.

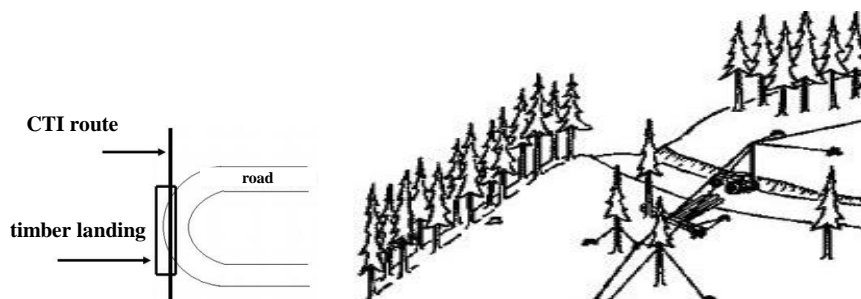

Fig. 81. Options of timber unloading under the skyline

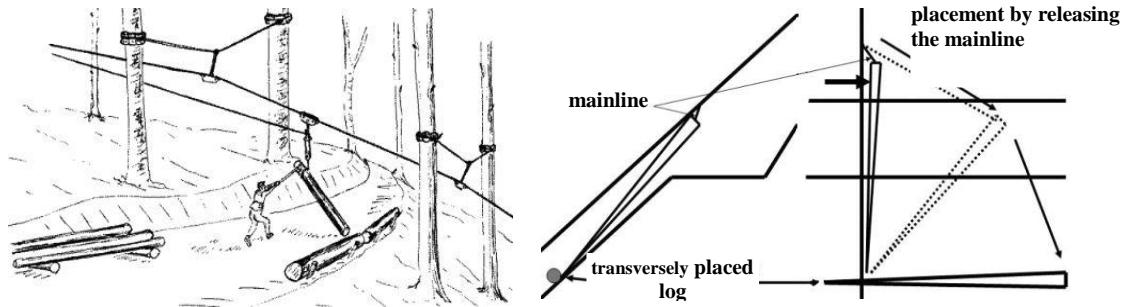

Fig. 82. Timber unloading with turning the load in the haulage direction

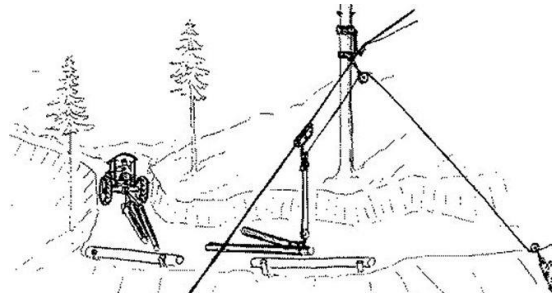

Fig. 83. Pulling the load away by tractor

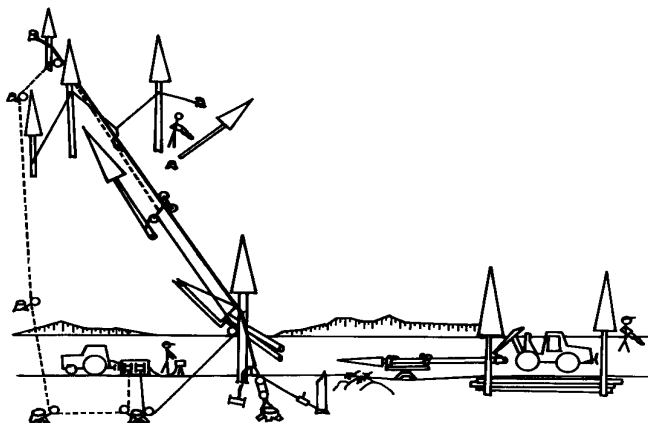

Fig. 84. Pulling trees away from the skyline integrated with delimiting using the branch-trimming unit

Universal CTI  
 – skyline,  
 mainline,  
 haul-back  
 line,  
 whole tree  
 harvesting  
 with hauling  
 down the hill

The width of CTI route ranges between 2 to 4 m in dependence on the logging method and the height of skyline course. The higher the skyline is suspended, the narrower the route can be because the area diminishes, on which the timber turning under the skyline takes place. Placing the CTI route at right angles to the contour is most frequent; however, a diagonal placement is technically possible as well. If the route is led diagonally, however, a one-span CTI should be given preference because passing jacks may cause difficulties at the diagonal route placement. The whole-stem logging method has been the most frequently applied method in cableway logging as yet, at which those stems are cross-cut only that would exceed the CTI carrying capacity by their weight. Using the whole-stem logging allows to free up one wood-cutter and brings a significant increase of occupational safety because the riskiest operation – delimiting by means of a chain power saw in difficult terrains does not take place. Clearing the brush from the logging site at the same time with the logging is a benefit, too. If the terrain configuration requires to pull timber away from the skyline, it is just perfect to use the whole-stem logging because a combination of timber pulling away and delimiting (by processor) is very useful. If the logged trees with crowns exceed the CTI carrying capacity, their rhizome parts can be cut off, delimited and transported as finished round timber.

The construction and operation of CTI in improvement felling have some specificities due to the low volume of trees to be felled and the low timber concentration for harvesting per one route. The working

field width can be enlarged only by skidding from the side using other means (horse, reel). Since it would not be possible to manage harvesting and skidding from the side simultaneously with harvesting and skidding in spans, it is carried out in advance. An option is to process the whole span in advance so that in Stage 2 only the route is constructed and timber skidded.

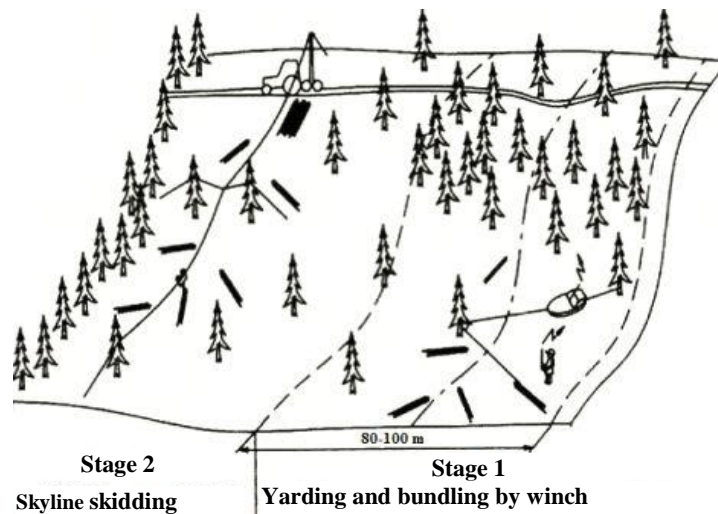

**Fig. 85. Extending the working span in improvement felling using a mobile winch**

The essential requirement for environmentally-friendly logging and timber yarding puts high demands on the directional felling (stands are difficult to pass, branched, and usually also with a high number of fractures and died individuals). The frequent requirement for an as narrow as possible CTI route (up to 2 m) is not quite rational, because a working span width of 40-80 m is usually chosen in order to have an acceptable timber concentration for felling. At such a spacing of routes, forest soil taken is by no means extraordinary and efforts on a narrow route can lead to increased damage to border trees that occur at turning the load towards the skyline. Support systems are assembled and skylines are anchored on the trees of smaller dimensions. Accordingly, jacks cannot be high above the ground and thus this is why there must be more of them. Anchoring must be on several trees or stumps after the previous stand. In some cases, support trees and mast trees usually must be reinforced and anchored multiple times. It is appropriate to use tower CTIs in which one route end is resolved. Labour intensity of building CTI is higher than in the main felling. For this reason, in traditional cableway regions, a sufficient number of trees from previous stands is left to “get engaged” in the subsequent stand, serving the purpose of CTI construction at the stage of subsequent intermediate felling. Trees from neighbouring stands can be used as mast and anchoring trees, too. With respect to the low stem volume of trees in the improvement felling, it is usually not necessary to dimension the CTI route to the full carrying capacity and presuming that the theoretical carrying capacity of CTI will not be utilized, the sag calculation can be modified in the sense of not using  $Q_{max}$  or  $Q/2$ . The requirement for directional skidding under the skyline is strict; extraction lines should lead to the skyline at a maximum angle of  $45^\circ$ . In selective felling on slopes a rule applies that the steeper the slope, the sharper the angle of extraction should be to reduce a possible timber rolling to sides and thus the risk of damage to standing trees. A carriage has to be available that can be arrested at any place of the route and it is useful if its angle to the skyline is changed during the extraction. The skyline height above the ground should be preferably maximum possible because the area affected by turning under the cable is thus getting smaller; this however collides with the size of trees. As a general rule, the spacing of CTI routes (working span width) is governed by the used CTI type, by the concentration of timber to be felled, by the method of logging, and by the harvesting system. The spacing of routes is usually 40-80 m, depending on whether the skidding under the skyline is carried out using only the mainline or other means as well (horse, mobile reel). Seeking an optimum spacing of routes is seeking an economically viable sum of costs for the CTI assembly and operation. Although the increased spacing of CTI routes reduces the costs of mounting and dismantling, however, the labour intensity and cost of skidding increases at the same time.

## 5.2 Repair, maintenance and occupational safety

A reliable and safe CTI operation requires professional repair and maintenance. The purpose of maintenance is to prevent unexpected accidents, downtimes, and to endanger occupational safety and the environment; their function is mainly prevention. They can be divided into

- Routine maintenance: carried out by operators daily according to operation and maintenance instructions: cleaning, lubricating, tightening joints, checking the conditions of cables and pulleys, supplementing various media etc.
- Routine inspections: carried out in the maintenance workshop usually once a month. These are larger-scale works prescribed in operation and maintenance instructions: changing oil fillings, adjusting and calibrating various aggregates, replacing filters, checking measurements of operational quantities etc.

Repairs can be divided into

- Routine repairs: carried out upon the occurrence of a failure which shows as damage to the structure, function failures etc.
- Preventive repairs: planned according to recommendations of the manufacturer, e.g. so-called medium repairs, or according to the actual condition of technical equipment – general overhauls.

Individual parts of CTI should be repaired or replaced as soon as their technical conditions jeopardize the function, economy and safety of operation. For example, a steel cable has to be replaced as soon as a conspicuously narrow place occurs on it, a ruptured strand, or a deformation due to tightened sling or a larger number of broken wires. Evaluating the cable condition, corrosion and wear of wires must be taken into account, too. Operation and maintenance instructions represent the most important technical document for operators that must be followed.

**Main principles of occupational safety with CTI** are as follows:

- If cables are moving, staying between them or under them or under the load should be prevented.
- Load may be directed using hand tools only if it is at rest and if cables are at rest, too.
- Load may be accessed from the upper side only.
- It is allowed to fasten and loosen the load only after cables have stopped and their tension has been released.
- Tightened cables must not be stepped over.
- Nobody is allowed to stay within the internal angle of tightened cables and in their extended direction.
- At the end of work, the cableway carriage must be secured against accidental setting into motion.
- Tension in cables must be released at the end of work.
- At climbing trees, workers must be secured by the protective belt.
- The CTI route must be marked with warning signs at road crossings. As the skylines can be easily overlooked against the sky, the roads must be closed for vehicle traffic.
- The felling of trees within a distance of the two height of felled trees is forbidden during the CTI operation.
- Prior to launching the cableway construction and after its disassembly, pulleys, guy lines, grass lines, chokers, and movable parts of CTI must be checked.
- Climbing the skyline and auxiliary lines during the erection and maintenance is forbidden.
- Staying under trees and supports is forbidden during assembly on them.
- The weight of transported load must not exceed the weight of transported load specified by the manufacturer.
- Stepping over or on the dragged stems and transporting of persons by the cableway is forbidden.
- Each CTI operator is obliged to use the prescribed protective equipment.
- Power supply stations must be secured against a possibility of being put into operation by unauthorized persons.
- Manufacturer's instructions must be followed at assembly, dismantling, operation, and maintenance.
- At working outside the cab of skidders, workers must wear helmets.
- Load must not be transported above the persons or in their dangerous vicinity.
- Working near the power line protection zone is not allowed.
- Any works on the distribution lines of hydraulic and pneumatic systems may be carried out, if these are under pressure.

- At skidding, the worker must watch the slope above him because stones, root cakes, stems, etc. may come loose.
- Nobody is allowed to stay on line perpendicular to the contour below the place of skidding.
- Simultaneous felling and skidding of timber are forbidden
- Work must be interrupted during storm, heavy rain and strong wind, at visibility reduced below 100 m and air temperature lower than -20 °C.
- Upon the end of work, the cable carriage must be secured against motion.

### 5.3 Algorithm of CTI choice

Cableway yarding is organisationally and financially more demanding than skidding by wheeled machines. Therefore, such a CTI type should be procured, for which the following slogan would apply: “the worse (cheaper) will not stand up and the better (more expensive) is superfluous”. The algorithm of selecting a suitable type is approximately as follows:

#### **1. Will a short-route tractor adaptive cable system be sufficient?**

*YES* – applies if the system is to be used both seasonally and all year-round on short routes (slopes and terrains of low bearing capacity), for lower stem volumes of felled trees and also if locations for the power supply station on UKT (general purpose wheeled tractor) are accessible. Where other uses are concerned, the answer is **NO** – proceed to paragraph 2.

#### **2. Is a CTI sufficient for hauling timber up the hill?**

*YES* – applies if short routes on slopes that are accessible via ridge roads are used all year round. If selective logging is required, a carriage is necessary that can be arrested at any place of the route. If another case is concerned, the answer is **NO** – proceed to paragraph 3.

#### **3. Will common types of universal CTIs suit? Timber hauling in all directions, usual range, and a common solution of chassis?**

*YES* – applies for year-round usage and required carrying capacity of 1.5 tons, length of routes up to 500 m and if locations of power supply station are accessible for UKT. In another case, the answer is **NO** – proceed to paragraph 4.

**4. If requirements for the carrying capacity of common cableway types (also in the production of short assortments in the stand) are exceeded, it is necessary to select a type with a higher payload. If requirements for route length of common cableway types are exceeded (also at constructing route “in two parts”), it is necessary to select a type with a longer effective route, if it is a long-term requirement! If places for the power supply station are not accessible by road, an off-road chassis type, possibly a sled chassis, has to be chosen.**

### 6. Designing CTI

A suitable location for the CTI power supply station is sought, possibilities are verified for the skyline upper and lower anchoring, working span shape and size are proposed and cardinal route points and place and dimensions of timber landing as well as haulage direction are determined during field works. Map data are compared with actual situation, suitable anchor, support and mast trees are indicated and slanting distances of terrain gradient changes and angles of inclination between them are measured during **rounds in the field**. Data are recorded numerically as well as graphically in the **field book** that is a basis for plotting the route **longitudinal profile**. **Cableway route** is usually a straight line without horizontal deflections, connecting mast trees that are end points of the effective route length. In the terrain, it is set out by means of stakes or compass tacheometer or compass. An inclinometer and builder’s tape are used for sighting the **longitudinal profile**.

If one possible mast tree only is available at one end of the route, while there are several of them at the other end, the route **setting out and sighting begins from** this determining mast tree. Otherwise, it always starts from the place of the future power supply station. The route is usually set out by extending straight line using three stakes that are carried by 2-3 surveyor’s assistants. Individual alignments are

not made longer than 20-40 m, even if the terrain nature would allow that. Each terrain gradient change is carefully recorded by measuring the slanting distance and the angle of terrain inclination from the last measured point. At all measured points, stakes with the point number are driven into the ground. Point numbers, slanting distances and terrain inclinations between them are entered and drawn in the field book. At the same time, all trees suitable as support and anchor trees are drawn, and their dimensions are recorded (at all times, more trees are drawn than estimated as necessary, because this is the only way how to avoid another field round if a need arises during the office work to include a further jack or to anchor on more trees). When the end point of the route has been reached, a control measurement of slanting lengths and angles of terrain inclination is performed on the way back to the starting point with the fitting of measurement errors.

Department			
Workplace			
Point. No.	Inclination (%)	Slanting distance (m)	Assembly description
1	-	-	Anchoring stump, BE diameter 55 cm
1-2	+ 12	22.3	Mast tree, SP d <sub>1.3</sub> 36 cm
2-3	+ 4	8.6	Terrain gradient change
3-4	+ 4	6.8	Terrain gradient change
4-5	+ 14	49.2	Possible support, right 4.2 m SP d <sub>1.3</sub> 30 cm, left 3.9 m, SP d <sub>1.3</sub> 32 cm
5-6	+ 26	14.4	Terrain gradient change
6-7	+ 35	32.3	Possible support, right 3.0 m BE d <sub>1.3</sub> 34 cm, left 3.6 m, BE d <sub>1.3</sub> 32 cm
Date			
Measured by			

Table 8. Example of a field book

The **project design of CTI**, which is the basis for its implementation, is elaborated in the **office**. The route longitudinal profile is plotted first of all and the necessary quantities of support (lowering) jacks, minimum height of jacks above the terrain, inclination of spans of unloaded skyline, maximum skyline sag due to maximum load in the middle of the longest span, assembly and maximum tension of skyline, pressure on supports and dimensions of anchors are then determined mathematically and graphically. The sequence of works is as follows:

- a) plotting the longitudinal terrain profile (usually drawn on the graph paper, on a scale of 1: 1000 or 1:500. For routes over 350 m a paper of A2 format is needed) - plotting the mast trees
  - designing the raising jacks (usual design jack height is 7 m, maximum 10 m).
  - plotting the anchor trees
  - inserting the vertical alignment of skyline
- b) determining the total horizontal route length (L) and total slanting route length, as well as the horizontal length (l) and slanting length (l') of individual spans
- c) calculation of tension increased under load  $S_Q$ , and calculation of maximum sag of the skyline  $f_{max}$  (calculation of both values differs for multi-span and one-span CTI).
- d) graphical representation of load trajectory along the skyline
- e) final determination of the heights of raising jacks, corrected according to the result of the previous point. Minimum height of a jack above the ground is the cable sag value + 1.5 m so that the load remains in semi-suspension, (1 m is the load safety height above the ground and 0.5 m is considered the transported butt end and choker length).
- f) determination of the angles of deflection points on the raising jacks. Vertical angles of the deflection points of two neighbouring spans on the raising jack may be within the range of (1)2-17 ° (ideally 5-8 °). On the lowering jack, the vertical angle of deflection point may be up to 10 ° and should not exceed 60 ° on the impassable jack. That is why further corrections of jack heights can follow even after this point.
- g) determination of forces applied on raising jacks and transmitted onto support trees
- h) verification of the required strength of support and anchor trees, and verification of the strength of artificial supports where applicable.

Note: Special computer applications are already available that facilitate CTI designing including calculations of quantities and drawing of the longitudinal profile of cableway route. However, as these modern methods may not be available at all times, the knowledge of the traditional manual elaboration of CTI project design is desirable.

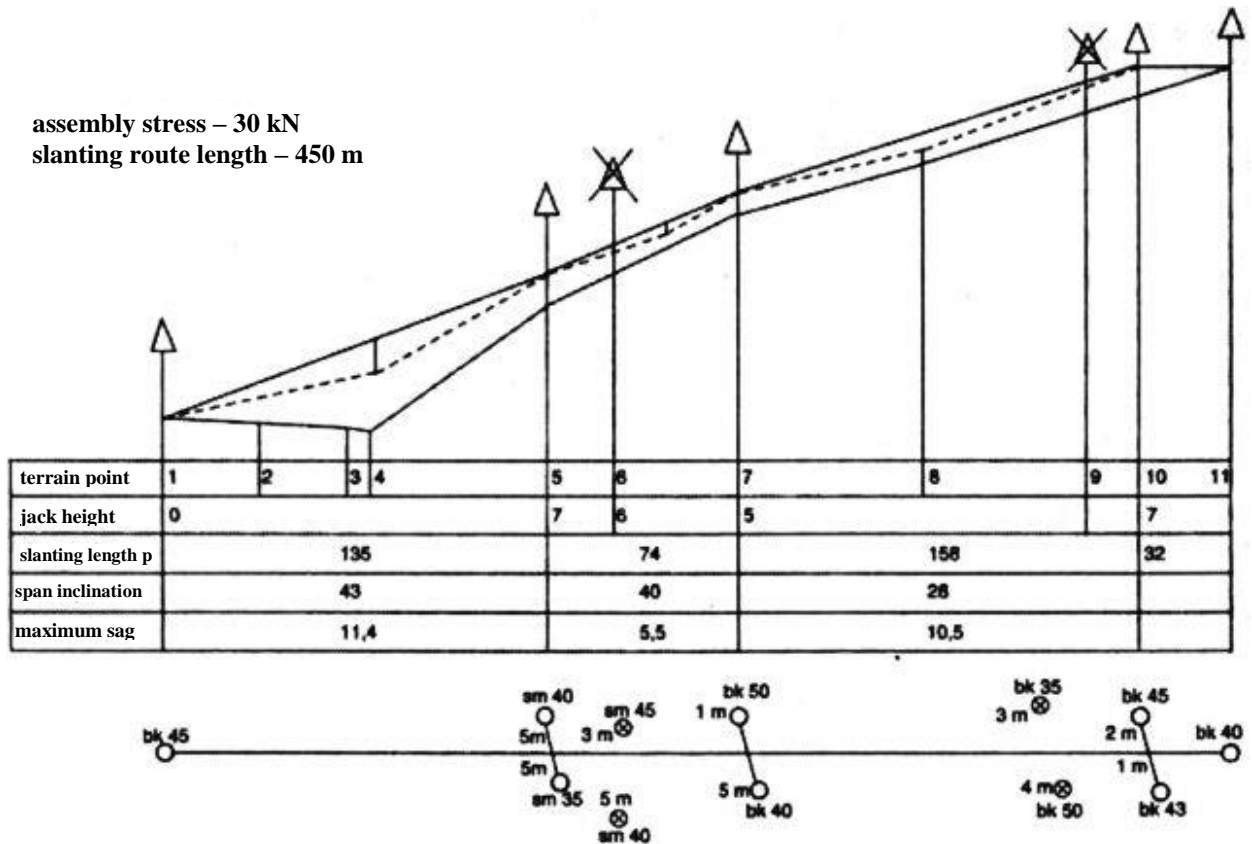

Fig. 86. Example of CTI longitudinal profile arrangement

### Summary of the issue of designing cable transport installations

The project of CTI is a laborious and expertly demanding matter. However, it should be noted that experienced **riggers proceed** at preparing CTI construction **in a simplified way** exploiting experience or various aids, tables and alignment charts **in common operational practice**. In addition, CTI manufacturers have been striving for such a design of equipment in recent years, which would reduce the needed calculations to the necessary minimum (e.g. motor-powered stretching of skyline ensures its constant stress and therefore no need to calculate assembly stress). Instructions for calculations in CTI designs, needed formulas, tables, graphs, and nomograms as well as examples of calculations can be found in manuals for riggers or in specialized literature. However, it should also be emphasized that **CTI cannot be installed responsibly without preparation**. CTI must be installed with a high degree of certainty that the stress of its components including supports and anchors is not exceeded in its operation, that the route will be led in the optimal direction and will be suitably connected to forest roads, etc. Therefore, it is a necessity also for experienced riggers that are familiar with CTI used by them, to lay-out the route of future cableway in the stand, to consider its course with respect to the longitudinal profile, to select the number of spans, anchor points, supports, etc. It is very important (even in case of CTI construction according to a completely elaborated project design) that a visual inspection and if possible, also an instrumental control of parameters is carried out (course of cables, condition of anchors, jacks, cable stress) after the CTI installation before starting its operation.

Designing cable transport installations is a highly professional and time-consuming activity. At the same time, however, it is absolutely necessary for the safe CTI operation (at least in a simplified form).

## 7. Cable transport installations of the Křtiny research station (Czech Republic)

The only manufacturer of forest cableways in the Czech Republic is currently the Research Station Křtiny which has been part of the Masaryk Forest Training Forest Enterprise in Křtiny since 1990, i.e. it is an organizational unit of Mendel University in Brno. Issues of forest cableways research have a rich and long-time tradition at this workplace because cableways have been researched here from 1950s onwards. After 1990, activities of Research Station Křtiny were modified so that development, manufacture and sales of machines were added to the research. In the portfolio of products, cableway timber yarding has become a carrier programme of Research Station Křtiny.

Cable transport installations developed and manufactured since the 1990s include:

**Tower cable system LS 2-500** (1991), four drums, carrying capacity 2000 kg, route length 500 m, motorised skyline tensioning.

**Small forest cableway Alpmobil** (1992), working gear in a steel housing of boat shape, built-in double-drum winch with a pulling force of 17 kN, 180 m capacity of  $\varnothing$  8 mm cable, cables are led out from the housing in reverse direction, which allows to move the machine across the terrain, suitable for intermediate felling and for bundling timber to forest cableway routes.

**Tower cableway Larix 550** (1996) intended for hauling timber uphill, downhill as well as on the flat in semi-suspension and/or in full-suspension. The driving and transport unit of cableway is agricultural tractor on the rear and front 3-point linkage of which a complete superstructure of cableway is suspended. It is a five-cable system that consists of track, running, lifting, auxiliary, and grass lines. Thanks to the endless line system, haul-back line braking is not necessary and thus no loss of energy happens. Cableway reach is 500 m, carrying capacity is 2000 kg. Mechanical drive, motorised skyline tensioning. Endless line assembled from segments of different lengths, out of which it is possible to put together a route length from 100 to 550 m. Auxiliary line is used as a grass line during the cableway construction and for motorised sliding out of extraction cable from the cable carriage during operation. Computer controlled, operated by the command radio-station.

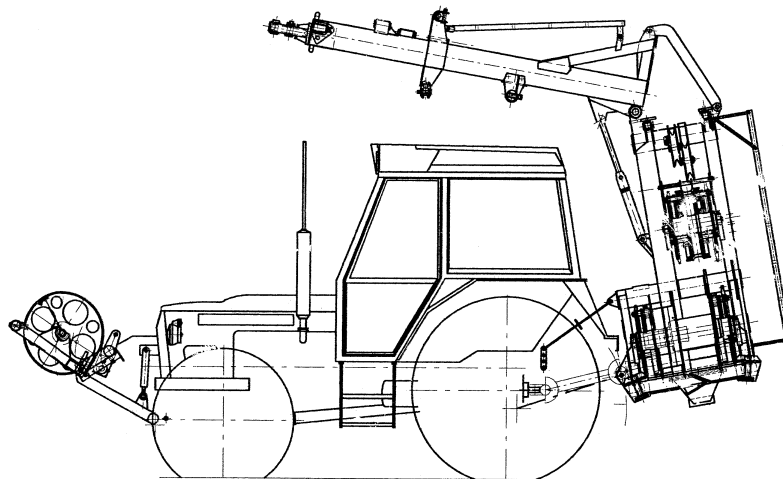
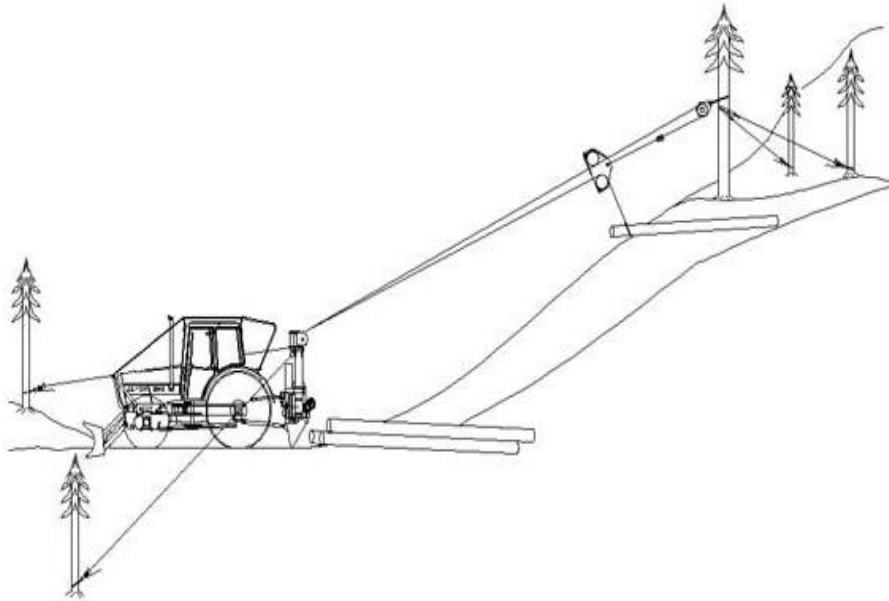

Fig. 87. Larix 550 forest cableway





**Fig. 88. Larix Kombi as a cable system with the main and haul-back lines**

**Larix Kombi Cable system** (1998), is a universal tractor cable system, composed of double-drum large-scale winch with the mechanical drive, connected with the skidding shield and tower. Mounted on the tractor three-point linkage. It can work as a skidding tractor with the forestry superstructure, too. It is also possible to construct a cable system with the operating and haul-back lines of 220 m in reach, or with the track and mainlines of up to 270 m in reach. In 2005, it was additionally equipped with the hydraulically tensioned skyline and hydraulically tilting tower –**Larix Kombi H** type. Thus, it is possible to obtain a cable system with the track, operating, haul-back and grass lines, with a tower of 6 m in height, 350 m in reach, and carrying capacity of 2000 kg.

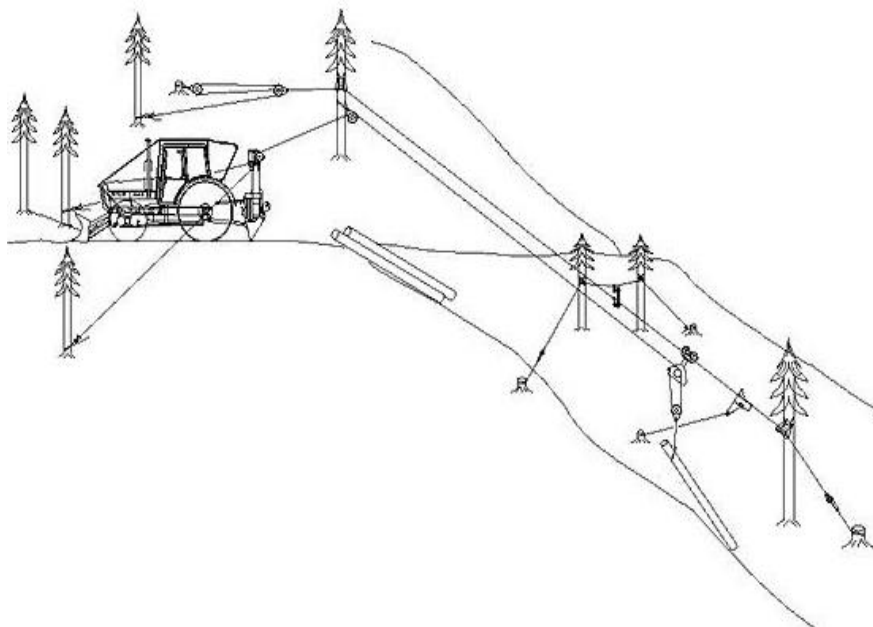

**Fig. 89. Larix Kombi with the track and mainlines, timber hauling uphill**

**Larix 3T (Tower) Forest cableway** (1999) builds on the previous type of Larix 3T. It is intended for hauling timber uphill, downhill as well as on the flat terrain, in semi- or full-suspension. The driving and transport unit of cableway is agricultural tractor, on the rear and front 3-point linkage of which a complete cableway superstructure is suspended. It is a five-cable system that consists of track, running, lifting, auxiliary, and grass lines. High field accessibility of tractor with the mounted superstructure. A

universal cable system for all terrain shapes and skidding directions. Thanks to the endless line system, haul-back line braking is not necessary and thus no loss of energy happens. Radio control from two different places including back-up cable control. Target automation with memory commands for empty and loaded cable carriage movement.

**Standard equipment:**

- skyline 650 m Ø 18 mm
- endless line 1 700 m Ø 12.5 mm
- hoist line 200 m Ø 12.5 mm
- auxiliary line 650 m Ø 6 mm
- grass line 1 100 m Ø 8 mm polypropylene
- mechanical carriage KOS-31.

**Basic technical data:**

Carrying capacity 3 000 kg

Pulling force/speed – skyline 50 kN / 2.2 m.s<sup>-1</sup>

Pulling force/speed – endless line with load 26 kN / 2.1 m.s<sup>-1</sup>

Pulling force/speed – endless line without load 10 kN / 5 m.s<sup>-1</sup>

Pulling force/speed – hoist line 28 kN / 1.5 m.s<sup>-1</sup>

Tower height 6.4 m

Weight – winches + tower 2 500 kg

Weight – drums with endless line 1 300 kg

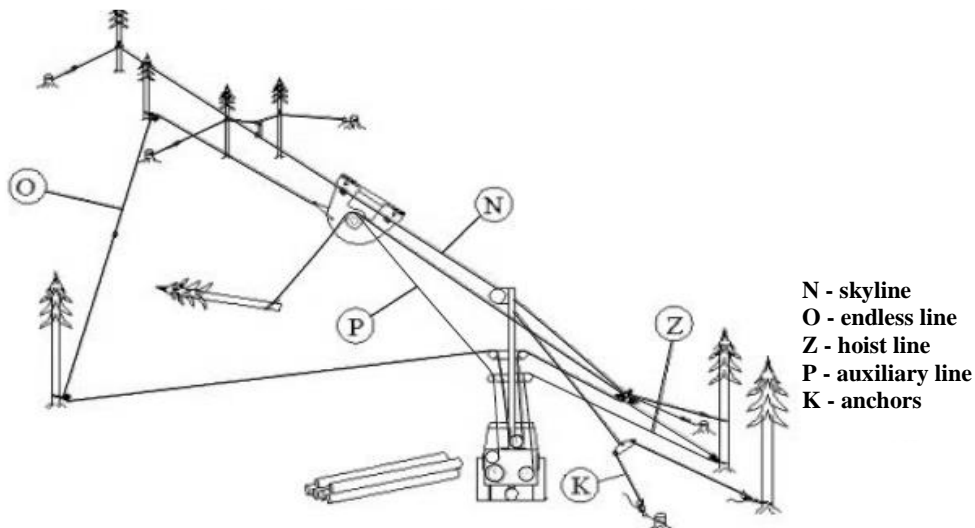

**Fig. 90. Larix 3T Forest cableway – Scheme**

**Larix Hydro 1 Tower cableways** (2001) on the Tatra 815 chassis and **Larix Hydro 2** (2002) on the separate trailer. The forest cableway superstructure – tower winch including the stationary motor is either built in on the platform of an off-road truck or it is mounted on the three-point linkage of tractor min. 70 kW and driven by its power take-off shaft. It is a classic concept with operating, haul-back, track, auxiliary, and grass lines. Auxiliary line ensures extraction of the mainline extending from the carriage (Larix Hydro 1) or the extraction of the mainline extending is ensured by motorised cable carriage (Larix Hydro 2). Hydrostatic drive of drums provides for synchronization of the rotation of operating and haul-back drums, and braking of the haul-back line at skidding downhill is not necessary. Computer controlled; radio operated. Tower height 11 m.

**Larix Lamako Quick-assembly tower cableway** (2008) is intended for lower felling concentrations (Lamako = lanovka malých koncentrací in Czech). It is mounted on the three-point linkage of Zetor 115 Forterra tractor or of a similar type of tractor. The concept includes a three-cable system, a tower of eight meters, track, operating, and haul-back lines. 500 m reach, pulling force 27 kN. Mechanical drive. Computer controlled; radio operated. It is already effective for concentrations of 0.5 m<sup>3</sup>/1 m of cableway route. A new version **Larix Lamako P** was developed in 2013, which is mounted on a separate trailer and driven by its own stationary motor.

**Larix H3-650 Cableway with hydrostatic drives**, has a reach of 650 m, carrying capacity 3000 kg, universal – downhill and uphill, on the flat. Classic concept: tower winch, with the track, operating, haul-back and grass lines. Winch placed on a trailer towed by tractor or truck, powered by the stationary 93 kW motor. Self-acting regulation of drums that are powered by hydraulic motors. The operating and haul-back lines work with braked power recovery. Target automation with programmable speed.

Type	Description	Min. timber concentration on route (m <sup>3</sup> /lin.m) *)	Assembly/ dismantling time (h) *)
Larix Kombi	2-cable system, 200 m reach, 37 kN pulling force	0.5	2/2
Larix Kombi H	2- cable system, 350 m reach, 25 kN pulling force	0.5	2/2
Larix Lamako	3-cable system, 550 m reach, 27 kN pulling force, driving speed 2 – 5 m/s	0.5	3-4/3
Larix Lamako P	3-cable system, 550 m reach, 27 kN pulling force, driving speed 1 m/s and 2 – 5 m/s	0.5	3-4(6)/3
Larix 3T	5-cable system with endless line, 650 m reach, 27 kN pulling force, driving speed 2 m/with and 2 – 5 m/s	1.0	8-14/6
Larix H3-650	trailer, 3-cable system, hydrostatic drive, track, operating, haul-back line, 650 m reach, 32 kN pulling force, driving speed 3 – 5 m/s	1.0	4-6/4
Larix H4-800	trailer, 3-cable system, hydrostatic drive, track, operating, haul-back line, 800 m reach, 40 kN pulling force, driving speed 3 – 5 m/s	1.0	4-6/4

\*) data are indicative only

**Table 9. Larix line cableway types**



**Fig. 91. Larix 3T Forest cableway**



**Fig. 92. Larix Lamako Forest cableway**

## 8. References

- Baadsgaard - Jensen, J. (1988) *Comminution and application of forest residues*. Skovteknisk Institut Denmark.
- Bauer, F., Ryšavý, I. (1985) *Hydraulické systémy mechanizačních prostředků*. VŠZ v Brně, 140 p.
- Bozděch, J., Černák, J. (1986) *Tabulky hmotnosti ihličnatého a listnatého dřeva*. Alfa Bratislava.
- Černý, Z., Neruda, J. (2001) *Příprava půdy v lesním hospodářství*. IVVMZE, Praha.
- Černý, Z., Neruda, J., Lokvenc, T. (1995) *Zalesňování nelesních půd*. IVV MZe ČR.
- Douda, V. et al. (1974) *Mechanizační prostředky lesnické*. SZN Praha.
- Drápal, D. et al. (1980) *Hydraulická ruka v lesním hospodářství*. Praha.
- Dressler, M. (1982) *Význam a uplatnění limitujících faktorů pro těžební technologie*. Lesnický průvodce, č. 2/. Praha, VÚLHM.
- Dressler, M., Adámek, I. (1960) *Vyklizovací lanovky*. Praha.
- Ericsson, L. G. (1994) *Amount of tree residues following harvesting of wood fuel*. Project Skogskrift Rapport nr. 20, Vattenfall, Stockholm, Sweden, Report U (B) 1993/28
- Erler, J. et al. (2012). *Forsttechnik*. TU Dresden.
- Fojtík, V. a kol. (1985) *Soustředování dříví lanovkami*. Praha.
- GUV. (2005) *Seilarbeit im Forstbetrieb*. GUV-I 8627 Bundesverband der Unfallkassen, München. Kostrůň, L. a kol. (1971): *Lesní těžba a dopravnictví*. Praha.
- Havlíček, J. a kol. (1989) *Provozní spolehlivost strojů*. Státní zemědělské nakladatelství v Praze, 610 p. ISBN 80-209-0029-2
- Horek, P. et al. (1991). *Lesní lanovky*. Křtiny.
- Jasenský, L. (1987). *Lanové systémy v sústred'ováni dřeva*. Bratislava.
- Jurča, V. (2004) *Informační systémy v oblasti údržby*. Učební text pro vzdělávací program ČSPÚ „Manažer údržby“. 64 p.
- Jurča, V., Hladík, T. (2006) Maintenance Data Evaluation. *Exploatacja i niezawodnosc*, 3(31): 15-18.
- Klíma, J. et al. (1982) *Lesář – dřevorubec*. SZN Praha.
- Legát, V. et al. (2007) *Systémy managementu jakosti a spolehlivosti v údržbě*. Česká společnost pro jakost. 192 s. ISBN 978-80-02-01979-7
- Legát, V. et al. (2008) *Jakost, spolehlivost a obnova strojů*. (Učební texty) ČZU, Praha, CD, ISBN 80-813-1514-8
- Löffler, H. (1986) Bodenschäden bei der Holzernte, Ursachen, Folgen, Vorbeugung. *Holz-Zentralblatt*, 149: 2190-2192.
- Lukáč, T. et al. (2001) *Lanovky v lesnictví*. Zvolen.
- Matthies, D. (1998) Möglichkeiten und Grenzen für die Definition einer ökologischen vertredlichen Befahrbarkeit KWF Workshop. *Forsttechnische Informationen*, 3: 29 -36.
- Meng, W. (1978) *Baumverletzungen durch Transportvorgänge bei der Holzernte*. Stuttgart.
- Messingerová, V. (2001) *Lesné dopravnictvo. Návody do cvičenia*. TU Zvolen.
- Mikleš, M. (1999) *Teória mobilných strojov*. TU Zvolen.
- Moudrý, J. et al. (1980) *Práce v komplexních četách*. Praha.
- MZ ČR (1992) *Příručka pro majitele lesa*. Praha, Agrospoj.
- Němec, J. (1959) *Technická příručka lesnická*. SZN Praha.
- Neruda, J., Simanov, V., Klvač, R., Skoupý, A., Kadlec, J., Zemánek, T., Nevřkla, P. (2013) *Technika a technologie v lesnictví. Díl první*. Brno: Mendelova univerzita v Brně. 364 p. ISBN 978-80-7375-839-4
- Neruda, J., Simanov, V., Klvač, R., Skoupý, A., Kadlec, J., Zemánek, T., Nevřkla, P. (2013) *Technika a technologie v lesnictví. Díl druhý*. Brno: Mendelova univerzita v Brně. 300 p. ISBN 978-80-7375-840-0

- Neruda, J., Švenda, A. (2001) *Malé technologie v lesním hospodářství*. Výukový CD ROM. MZLU Brno.
- Neruda, J., Ulrich, R., Vavříček, D., Nevrkla, P. (2011) *Interakce prostředí a parametrů strojů při optimalizaci technologických postupů lesní těžby*. In: Skoupý, A. (ed.). *Multikriteriální hodnocení technologií pro soustředování dříví*. 1. vyd. Praha, Lesnická práce, s.r.o., pp. 1-19. ISBN 978-80-7458-016-1
- Neruda, J., Ulrich, R., Vavříček, D., Nevrkla, P., Fiřo, P., Kadlec, J., Pohořalý, J., Šedivý, V., Skoupý, A., Klvač, R. (2012) *Analýza parametrů a souvisejících faktorů provozu výrobních technologií*. In: Kulhavý, J., Menšík, L. (eds.). *Les a dřevo: podpora funkčně integrovaného lesního hospodářství a využívání dřeva jako obnovitelné suroviny: významné výsledky institucionálního výzkumu Lesnické a dřevařské fakulty Mendelovy univerzity v Brně v období 2005-2011*. 1. vyd. Brno: Mendelova univerzita v Brně, 2012. pp. 262-268. ISBN 978-80-7375-608-6
- Neruda, J., Valenta J. (2004) *Determinace poškození lesních porostů těžebními technologiemi*. Monografie. MZLU v Brně, Folia Universitatis Agriculturae et Silviculturae Mendelianae Brunensis.
- Neruda, J., Vavříček, D., Ulrich, R., Janeček, A. (2011) *Interakce stanoviště a těžebně dopravních strojů*. 1. vyd. Brno: Mendelova univerzita v Brně. 91 p. ISBN 978-80-7375-573-7
- Novák, L. (1982) *Technologie těžby prořezávkového materiálu*. VÚLHM, Závěrečná zpráva výzkumu.
- Petr, J., Bartoš, Z. (1995) *Lanová dopravní zařízení*. Brno.
- Petříček, V. et al. (1984) *Mechanizační prostředky v lesnictví*. SZN Praha.
- Pohořalý, J., Neruda, J., Kleibl, M., Hubálková, I. (2012) *Soil bearing capacity detection according to changing humidity as a damage prevention caused by forest machinery movement*. In: *VII Krakowska Konferencja Mlodych Uczonych*. 1. vyd. Krakow: Grupa Naukowa Pro Futuro, 2012, p. 219. ISBN 978-83-62218-64-6
- Pošta, J. (2002) *Provozní schopnost strojů*. (Učební texty) ČZU, Praha, 95 p. ISBN 80-213-0966-0
- Rónay, E., Bumerl, M. (1982) *Doprava dřeva*. Bratislava.
- Rónay, E., Dejmal, J. (1991) *Lesná ťažba*. Bratislava.
- Rousek, M. (1996) *Tekutinové mechanizmy a vzduchotechnika*. MZLU Brno.
- Schlaghamerský, A., Roško, P. (1964) *Lesní vývozní lanovky*. Praha.
- Simanov, V., Kohout, V. (1993) *Asanace erozní rýhy*. Výukové video, AVC VŠZ v Brně, 10,0 min.
- Simanov, V., Kohout, V. (2004) *Těžba a doprava dříví*. Písek.
- Skoupý, A. (1990) *Návrh optimalizovaného systému péče o lesní techniku*. (Výzkumná zpráva úkolu č. VI-6-/06-06). Vysoká škola zemědělská v Brně, 65 p.
- Stanovský, M. (1990) *Mechanizácia výchovy a výroby dreva v predrubných porostoch*. Lesnícke informácie. Príroda Bratislava-
- Svaz zaměstnavatelů dřevozpracujícího průmyslu, Společenstvo dřevozpracujících podniků v ČR, Česká asociace podnikatelů v lesním hospodářství, Lesy České republiky. (2002) *Doporučená pravidla pro měření a třídění dříví v České republice*. Svaz zaměstnavatelů dřevozpracujícího průmyslu, Společenstvo dřevozpracujících podniků v ČR, Česká asociace podnikatelů v lesním hospodářství, Lesy České republiky, Praha – Hradec Králové.
- Škapa, M. et al. (1987) *Lesní těžba*. Praha.
- Štaud, V. et al. (1963) *Technologická typizace a příprava pracovišť na úseku soustředování dříví*. Praha.
- Štollmann, V., Koska, P. (2001) *Lesnícke mechanizačné prostriedky*. Návod na cvičenia. TU Zvolen.
- Štollmann, V., Mikleš, M. (2001) *Lesnícke mechanizačné prostriedky*. TU Zvolen.
- Švenda, A. et al. (1983) *Technologie a příprava výroby dříví v lesním hospodářství ČSR*. Praha.
- Tomášek, L. (2003) *Pracovní postupy a zásady bezpečné práce při lesnických činnostech*. LČR s.p., Hradec Králové.

- Ulrich, R., Vavříček, D. (2013) *Certifikovaná metodika ukazatelů a systému technologických postupů v rámci těžební činnosti a udržitelného využívání lesních ekosystémů*. Osvědčení č. 49166/2013-MZE-16222/M66. MZe ČR, 45s.
- Ulrich, R. (1989) *Stroje a technologie pro těžební výrobu*. VŠZ v Brně.
- Ulrich, R. et al. (2006) *Možnosti uplatnění sortimentních technologií ve správě LČR s.p.* LČR s.p. Hradec Králové, MZLU v Brně.
- Vicena, J. (1964) *Ochrana proti polomům*. Praha.
- Wiesik, J. (1990) *Maszyny lesne I a II*. Wydawnictwo SGGW-AR Warszawa.

**Title:** **Cableways in forestry**

**Author:** prof. Ing. Jindřich Neruda, CSc., Ing. Pavel Nevrkla,  
Ing. Vladimír Simanov, CSc., Ing. Luboš Staněk,  
Ing. Tomáš Zemánek, Ph.D.

**Publisher:** Mendel University in Brno, Zemědělská 1, 613 00 Brno

**Edition:** first, 2023

**Number of pages:** 54

**ISBN 978-80-7509-960-0**

**<https://doi.org/10.11118/978-80-7509-960-0>**