

2023



**Jindřich Neruda et al.**

## **Tractors and skidders in forestry**

- **MENDELU**
- **Faculty of Forestry**
- **and Wood**
- **Technology**



prof. Ing. Jindřich Neruda, CSc. (the head of the author's team)  
Ing. Pavel Nevrkla  
Ing. Luboš Staněk  
Ing. Tomáš Zemánek, Ph.D.

---

## **Tractors and skidders in forestry**

- **MENDELU**
- **Faculty of Forestry**
- **and Wood**
- **Technology**



### **Acknowledgment**

This publication was created with the financial support of the Erasmus+ project “European Forest Machine Operators Certification” 2019-1-UK01-KA202-061846.



Co-funded by the  
Erasmus+ Programme  
of the European Union

### **Author’s address:**

prof. Ing. Jindřich Neruda, CSc.  
Mendel University in Brno  
Faculty of Forestry and Wood Technology,  
Department of Engineering,  
Zemědělská 3, Brno 613 00, Czech Republic  
jindrich.neruda@mendelu.cz

### **Reviewers:**

prof. Ing. Valéria Messingerová, CSc., Technical University in Zvolen, Slovakia  
prof. dr hab. inż. Józef Walczyk dr h.c., Agricultural University of Cracow, Poland

### **English language proofreading:**

Ing. William Robb, BSc (Hons), Mendel University in Brno, Czech Republic

© prof. Ing. Jindřich Neruda, CSc. et al., 2023

© Mendel University in Brno, Zemědělská 3, Brno 613 00, Czech Republic

© ABA International

**ISBN 978-80-7509-954-9**

**<https://doi.org/10.11118/978-80-7509-954-9>**



Open Access. This publication „Tractors and skidders in forestry“ is licensed under Creative Commons Attribution 4.0 (CC BY 4.0 DEED) International License

**Contents**

1. Classification of energy devices .....	4
1.1 Characteristics of tractors and prime-movers in forest production .....	4
1.2 Characteristics of some structural units of tractors and prime-movers .....	6
1.3 Multi-purpose wheel tractors .....	11
1.4 Single-axle tractors .....	16
1.5 Caterpillar tractors .....	16
1.6 Special forest wheeled tractors and prime-movers .....	17
2. Basic quantities of tractor mechanics .....	20
2.1 Tractor dimensions and stability on the slope .....	20
2.2 Traction capabilities of the tractor .....	22
3. Basics of terramechanics .....	23
4. Basic principles of hydraulic mechanisms .....	26
4.1 Advantages and disadvantages of hydraulic mechanisms .....	27
4.2 Theoretical basics of hydromechanics of hydraulic circuits .....	27
4.3 Hydrostatic systems .....	28
4.4 Hydrodynamic systems .....	33
4.5 Hydraulic liquids .....	34
4.6 Operation and maintenance of hydraulic circuits .....	35
5. Mechanised ground-based timber skidding .....	35
5.1 Cables, chains and chokers in forestry .....	35
5.2 Remote control of forest machines .....	45
5.3 Tractors and prime movers for choker timber skidding .....	49
5.4 Machines for chokerless skidding of timber by dragging .....	61
5.5 Timber forwarding machines .....	63
5.6 Combined ground-based timber skidding .....	70
6. Occupational safety and health .....	72
6.1 Safety cabs and frames of machines .....	72
6.2 Manoeuvrability of vehicles on slopes .....	72
6.3 Occupational safety and health in the European Union .....	73
6.4 Key principles of work safety at timber skidding .....	74
6.5 Practical recommendations for OHS .....	75
7. References .....	77

## TRACTORS AND SKIDDERS IN FORESTRY

### 1. Classification of energy devices

Energy devices are machines that transfer one sort of energy into another. They are mostly energy sources for other machines or machine parts, i.e. for appliances that use it for doing work. Two basic groups of energy devices are distinguished: **stationary** (engines, electric, hydraulic, and pneumatic source aggregates), connected with the appliance directly or through a supply line, which do not change their position during the work, and **mobile** that are typical in forestry and are equipped with a chassis allowing their displacement by their own power and can be used autonomously (as a source of tractive force or for transporting material or persons) or in conjunction with one or several adapters as a permanent or temporary set constituting one work unit. **Portable devices** held or carried by workers at work or for displacement that cannot be classified in any of the categories above are also common in forestry. Power chain saws, brush-cutters, hole diggers and motorised pesticide applicators belong to portable energy devices as well. Mobile energy devices used most frequently in forestry are those that convert heat energy contained in the fuel (diesel fuel, petrol) and released by its combustion to mechanical power used for travel, traction, and driving of working equipment – adapters. In addition to mechanical power, energy devices produce to varying degree also other energy forms: hydraulic, pneumatic, electric etc.

Mobile energy devices are used both on the unmade terrain and on roads including public roads and can be therefore considered motor vehicles. These vehicles are differentiated as follows:

- a) **transport machines** – passenger cars, trucks, special cars
- b) **prime-movers** - trailers or semi-trailers
- c) **tractors** – for hauling, dragging, shovelling, carrying, transporting materials and driving of working equipment (adapters)
- d) **self-propelled machines** - motor vehicles making one whole with the working equipment for performing a certain work task.

All groups of mobile energy devices mentioned above are applied in forestry, of which machines from the group of tractors and prime-movers are of key importance because they make a fundamental contribution to production operations of both basic forestry activities - harvesting and forest regeneration. Among others, they provide for the technological phases of timber yarding and haulage, site preparation for forest regeneration, afforestation and material transportation. In forestry, a **road prime-mover**, which is a vehicle suited to transport material loaded on trailers or semi-trailers has to be distinguished from a **forest prime-mover**, the basic design concept of which is similar to tractor, capable of driving in off-road conditions and on roads, but intended and almost exclusively used for transporting long timber by dragging. A forest prime-mover is not suited to couple and drive adapters in its basic form as is the case with tractor. Self-propelled forest machines, harvesters, and processors have been taking on an increased significance in recent years. The basic classification and construction characteristics of tractors, prime-movers and mobile machines in forestry, their properties, and particulars of occupational safety and health are listed in *ISO 6814:2009 Machinery for forestry – Mobile and self-propelled machinery – Terms, definitions and classification*.

#### 1.1 Characteristics of tractors and prime-movers in forest production

Tractors are mobile energy devices, the main characteristic of which is an easy coupling and decoupling one or several adapters as well as securing their drive using energy transferred from the tractor through mechanical and hydraulic mechanisms or possibly induced by tractor traction. There are several criteria for **distinguishing tractors**:

- **number of axles**: one-axle, two-axle, and multi-axle tractors
- **number of driven wheels**, e.g. four-wheeled tractors can have two wheels driven only (1 driven axle, designation 4 x 2) or all four wheels driven (2 axles driven, designation 4 x 4), multi-wheel tractors (6 to 8 wheels) which are particularly so-called forwarders with all four wheels, as a rule driven permanently
- **chassis design** and many other classification criteria

- external arrangement: frame and frameless chassis, compact chassis, split (articulated) chassis
- mode of movement: wheels, tracks, tracked-wheels, walking mode
- form of energy transfer onto the chassis: mechanical, hydrostatic-mechanical, hydrodynamic-mechanical transfer
- mode of directional control: by turning axles, by turning (articulating) front and rear chassis parts against each other, by turning wheels on axle, by speed change of wheels and tracks
- **design of machine nodes**: type of engine, number of gears and gear shifting method, cabin equipment, system of energy transfer to adapters, etc.
- **engine power**:
  - mini-tractors (one-axle types, operated by hand to 7 kW, two-axle types to 25 kW)
  - tractors ( $\geq 25$  kW)
- parameters derived from **quantities of tractor mechanics**: tractive force, climbing ability, carrying capacity, loads on axles and wheels, specific pressure on the soil, terrain passability etc.
- **type classification of tractor manufacturers**, e.g. according to unified series and types in case of inland tractors of the Zetor brand
- **basic and additional equipment** co-determining the purpose and area of tractor use (equipment with connecting elements – hitches for temporary and permanent coupling of adapters, winches, clam bunks, grapples, loading areas among others)
- **basic division** of two-axle and multi-axle tractors and prime-movers – it is common in this country to distinguish **multi-purpose** (agricultural) tractors provided with varied elements for coupling and driving adapters and **special** tractors. **Tool-carrying** tractors, characteristic of which is a possibility to mount adapters in the driver's field of vision and the lower engine power (to 25 kW), are a special sub-group of multi-purpose tractors. Unequally large wheels on the front and rear axle and steering by turning the front axle wheels are typical for the multi-purpose tractors. The same size of all four wheels and steering by articulating the front and rear half-frames around a vertical pin are typical for **special wheel tractors** (for those used in the Czech Republic in particular). Some types of special tractors used abroad are steered by the turning of wheels on axles. All four wheels of **special forest wheel prime-movers** are of the same size with the directional steering provided by articulating the front and rear half-frames around a vertical pin. They are equipped with mechanisms for timber yarding by dragging (winches, grapples) directly from the manufacture and are not suited to coupling and driving various adapters. Their climbing ability (40% at least), which is usually higher than that of multi-purpose tractors (around 25 %) is also characteristic for the special forest wheel tractors and prime-movers. **Forwarders** are provided with a loading area for the placement of timber logs, consisting of a set of stays as a rule. They are also provided with a hydraulic crane with the grapple for timber loading and unloading. Some typical features of individual groups of tractors and prime-movers are listed in Fig. 1.

**Travel**, i.e. continuous motion enabled by the running gear provided with wheels, tracks or tracked wheels is a common way of mobile energy devices movement but **walking** may be also encountered. A walking chassis has excellent terrain passability and does not create ruts. At the current level of solution, it cannot be used, however, for works where the main demand is transferring speed, namely at material transportation like timber skidding by wheeling or dragging. There are **two concepts** of machines with a walking chassis. A **typical walking chassis structure** used at excavators and some harvesters has the chassis provided with four hydraulically operated arms (out of which two are provided with wheels and two with supports). The forward movement of the machine is discontinuous and is carried out using an arm jib which reaches to its maximum, is propped on the terrain by means of its implement (shovel in excavator, head support in harvester), picks up the machine and pulls up the chassis by articulating to the place where the implement props against the terrain. Following the transfer, the machine continues to work or moves further on by repeating the previous actions. The backward movement is analogous with the exception that the implement on the jib props near the machine which is pushed from the place

of propping by means of the jib. The advantage resides in the possibility to work in strenuous terrains with an inclination up to 90 %, on non-bearing grounds or on rugged sites as well as the ability of the machine to “get on” and “get off” the means of transport by itself.

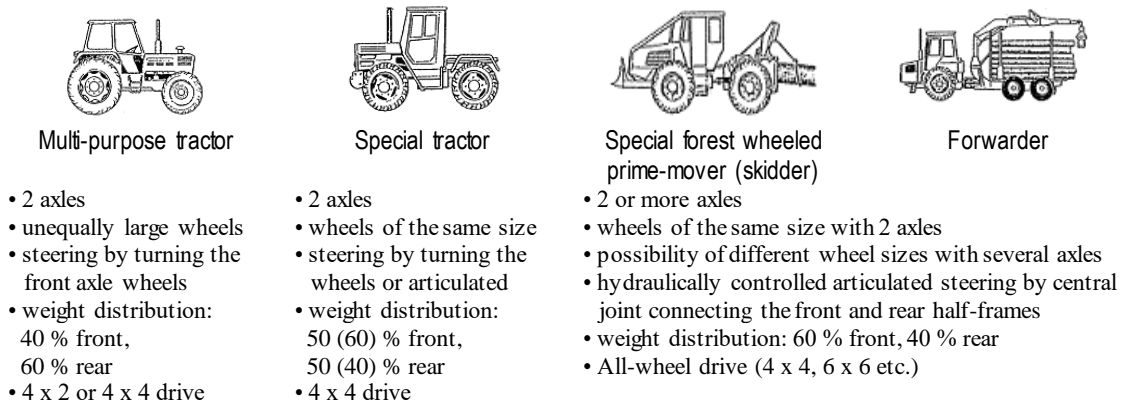


Fig. 1. Distinction of wheeled tractors and prime-movers

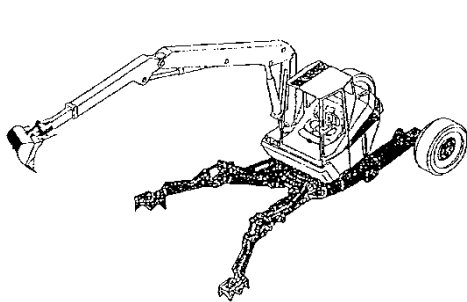


Fig. 2. Typical structure of the walking chassis

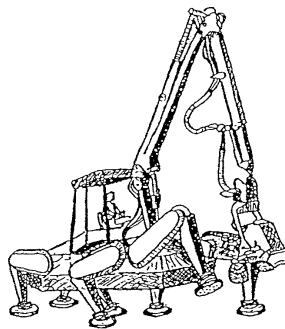


Fig. 3. Plustech machine walking chassis

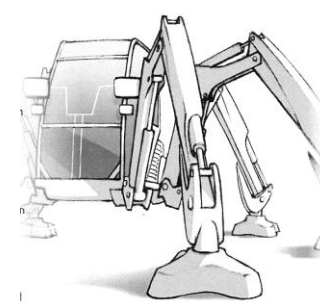


Fig. 4. Detail of the Mantis machine foot

**Another principle** is used in the walking chassis of the Plustech Company. It is provided with six hydraulically driven and electronically controlled legs, three of which are located on each side of the chassis and are independent from one another. The principle of legs motion developed at the end of the 1990s reminds us of the movement of insects, the machine travel is thus continuous. The structural design allows to change machine direction in motion as well as at rest and its movement forward, backward, and sideways as well as machine levelling on the slope. The legs have step-in surfaces with sensors checking the stability of each leg after stepping on. At all times, the machine leans at least on four opposite legs so that its stability is ensured. An on-board computer checks and controls the motion of legs, their position, and the stepping-on quality, while the operator steers the machine using standard controls. The Mantis Company machine introduced in 2013 has in principle the same chassis – hexapod. This machine is also in the stage of prototype so far.

## 1.2 Characteristics of some structural units of tractors and prime-movers

Two or three **essential parts** constitute tractor and prime-mover structures: machine undercarriage (chassis), body, and superstructure. The **machine undercarriage** consists of chassis with the driving system and accessories. The chassis consists of vehicle frame with axles with a running gear (wheels, tracks, and tracked wheels), steering, brake system and accessories. Other machine nodes are also attached to the frame, the drive system above all. The frame is missing in some machines (e.g. tractors of Zetor series), individual machine nodes of machine undercarriage are interconnected using screw connections and they are adopted also for fastening the axles. Frame chassis are more favourable for use in forestry because they are more robust and better resisting stresses associated with the deployment in often difficult terrains.

The **drive system** consists of a vehicle engine with the transmission gear. The engine is used to drive the vehicle directly and is capable of working in a spectrum of speeds and loads. Piston combustion-ignition engines are used. The aim is that these engines are effective, energy efficient, and that they comply with emission limits at the same time. Engines of current tractors are designed using many progressive structural members and electronic systems. Consideration is given to the quality of fuel mixture preparation (diesel fuel + air), engine reliability, and particularly to the use of electronics in steering and controlling the engine. Engines of current tractors use the principle of **supercharging** (turbocharger) or controlled fuel injection among others.

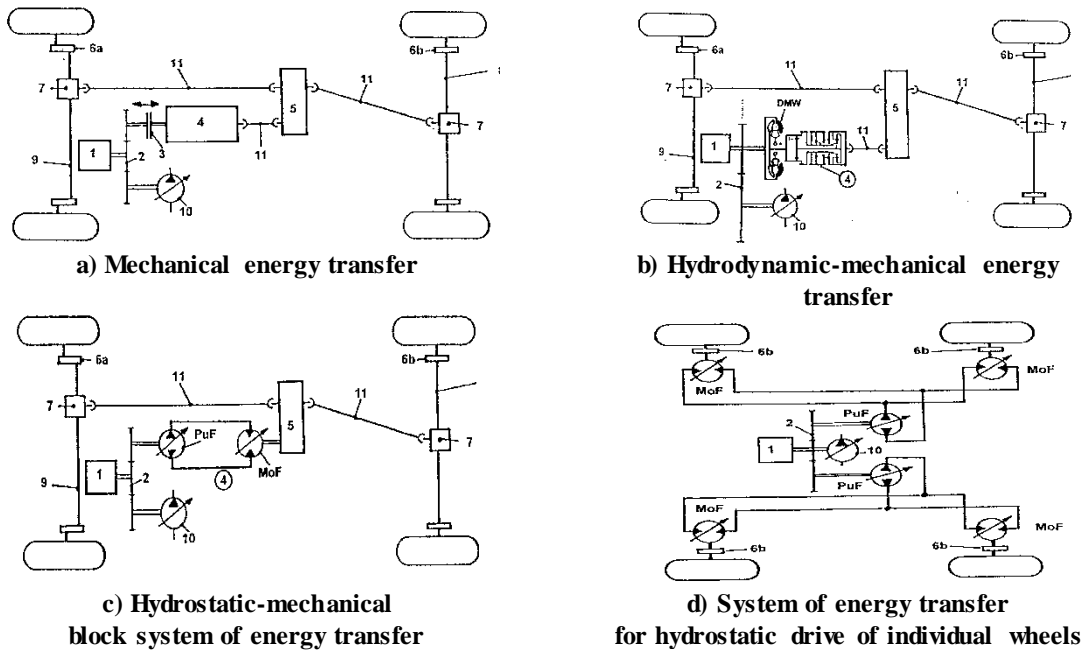
Supercharging ensures the increase of air mass transported to the cylinder. This allows injecting a greater amount of fuel to the cylinder, while the fuel combustion quality remains unchanged. This solution has the most significant effect on the engine power and its volumetric efficiency at the unchanged capacity of cylinders.

**Transmission gear** – all parts of the system for transmission, change and interruption of torque from the engine (gearbox, distribution gearbox – final gear, clutch etc.). **Energy transfer** from the engine to the running gear and to consumers is necessary for the machine movement and to obtain the necessary tractive force. Several design principles deal with this transfer. In all principles, the working hydraulic system (position 10) serving the purpose of driving control and working mechanisms has to be distinguished from the hydraulic system of travel (MoF position). The oldest principle of mechanical power transmission is typical for multi-purpose tractors Zetor of older series still used widely in the Czech Republic. More recent types of foreign and domestic tractors have energy transfer systems that use hydrodynamic or hydrostatic structural elements. These systems have several advantages such as a smooth start, possibility of smooth speed setting, possibility of engaging gears under load, fast change of travel direction forward and backward, limiting wheels slip, turning machine by changing speed of wheels (this principle is not typical for standard tractors and prime-movers, it is used on harvesters and forwarders among others), protection against overload of machine mechanisms, etc.

**Body** is the vehicle part with spaces established for using the vehicle according to its purpose or for placing parts of drive system possibly. A super-structure, i.e. purpose-built part of special vehicles (e.g. so-called logging rig at machines in forestry – a winch, platform loader, shield, jib with a grapple, working part of excavators, etc.) may be an important part, too.

Technical solutions of machine chassis design for **overcoming terrain unevenness's** allow that machine wheels (tracks, half-tracks) copy the surface of uneven terrain. They must guarantee a constant contact of all wheels with the terrain surface (ground). The principle common in road transport i.e. the **spring mounting of individual wheels** using coil or leaf springs is not sufficient in a complex forest terrain and is less appropriate for other reasons as well (undesirable machine drop at springs under load, the need of machine stabilisation etc.). Copying a terrain surface is dealt with by **unsplit swing axle** very often. The front (steering) axle is this axle in most wheel tractors; wheels are suspended on it so that they can be turned to the desirable direction of travel. The swing axle is used in some special tractors (prime-movers) with a central joint connecting both half-frames that enables their mutual turning in horizontal level only (e.g. LKT 81, 90). In that case, however, wheels are laid fixed on the axle. The swing axle is laid at a horizontal pin fastened on the machine frame or on the engine casing. Wheels can be spring-loaded (as usual at tractors with 4x2 drive) or unsprung on this axle. Stops limit the front axle swing in order to ensure the machine stability. Besides steering the machine with the help of chassis articulation (turning of front and rear half-frames around the vertical axis), the **central axial joint** allows also front and rear chassis parts tilting around the horizontal axis and thus also the adaptation of wheel positions to terrain unevenness's. It is necessary to limit the tilting around the horizontal axis for reason of stability on slope and at working with the hydraulic crane, too. This side tilt locking is done either mechanically using caterpillar brakes or stops or hydraulically by locking hydraulic cylinders connecting the flange of axial joint with the rear half-frame as a rule. It is used at some forest wheel prime-movers, harvesters, and forwarders.





1- combustion engine, 2- final gear (travel drive/working hydraulics), 3- travel clutch, 4- speed-changing gear (drive shifter), 5- final gear of front and rear axle, 6- drive of wheels (a-transmission by wheels with spur gearing, b-transmission by planet wheels, 10 pump of working hydraulics, 11- propshaft, PuF- pump of travel hydraulics, MoF- hydraulic engine of travel, DMW- torque converter

Fig. 5. Systems of energy transfer for tractor drive

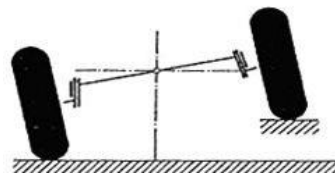


Fig. 6. Principle of swing front axle

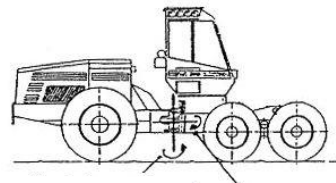


Fig. 7. Central axial joint

**Adjustment of individual wheels** (spider system) is used in the chassis of some forest machine types that have a central joint turning around the vertical axis only. Each wheel is fastened at a movable arm and is hydraulically set to the optimum position individually, positions of wheels are controlled using an on-board computer or manually, if needed. It is thus possible to level the machine up to a certain limit slope inclination when travelling along the contour line or perpendicularly thereto. It increases its stability because the centre of machine gravity may be moved nearer to the slope. **Bogie axle (also double swing or tandem axle)** is a much widespread structural design namely in logging-hauling machines, i.e. of harvesters and forwarders. Wheel shafts are firmly fixed to the common frame and this frame is symmetrically pivotally mounted on a pin fastened on the machine chassis frame. Swinging of a common frame is limited by stops. This structural solution allows the wheels to be loaded evenly all the time on uneven ground or when passing obstacles, to reduce the specific pressure on the soil at the same axle load as compared to individual wheels, and the chassis side tilt of  $\frac{1}{2} h$  to occur only when crossing obstacles of  $h$  height and a length smaller than the spacing between the wheels on the common frame (i.e. if the wheels of tandem axle cross the obstacles one by one). Bogie axle wheels can be driven as well as non-driven. A track can be fitted to the wheels of double axle, which further reduces the specific axle pressure on the soil and improves traction properties of the machine.

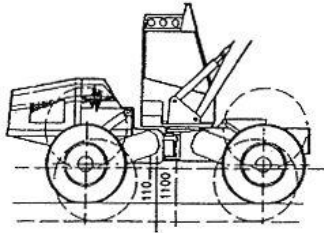


Fig. 8. Adjustment of individual wheels

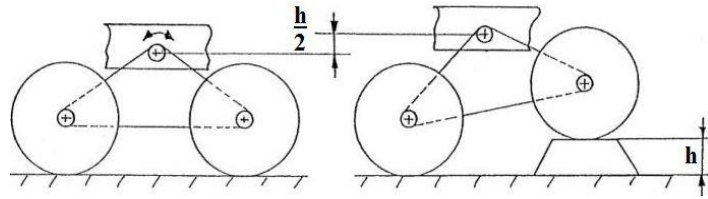


Fig. 9. Principle of bogie axle

**Systems of directional steering** of wheel vehicles are designed in several ways. **Turning wheels** on one axle, the front (steering) one usually, to the direction of travel is the most common. This solution is typical for multi-purpose tractors, cars etc. This principle of directional steering causes that each wheel of the turning machine moves in its own track (there the designation of four-track steering comes from) because another turning radius corresponds to it (wheels of rear axle move in smaller circles than adequate front axle wheels). The fact was taken into account e.g. at designing the system of making the road network accessible. Steering may be done also **by turning wheels on both axles**. Wheels may be turned mirror-inverted to each other (result being driving in a circle – two driving tracks) or may be turned in the same manner (so-called “dog run” – four driving tracks). This principle is used less frequently, namely in some special tractors. The articulating front and rear chassis on the central pin as described above is a common principle of directional steering. Articulation itself is provided by the hydraulic system. The force needed for turning half-frames is induced by linear hydraulic motors (hydraulic cylinder) connecting the two half-frames in the central pin area. Extending or retracting of piston rods of cylinders is controlled from the place of operator using a special distributor (Orbitrol system used in Slovak LKT machines is popular) provided with the standard steering wheel or lever control. If the bearing distance of axles from the central pin is the same on both half-frames, then only two driving tracks are made at turning (common in special-purpose forest wheeled tractors). Bearing distances of axles from the central pin are different on front and rear half-frames in some forwarders with articulated steering, however, thus the machines make four driving tracks at turning.

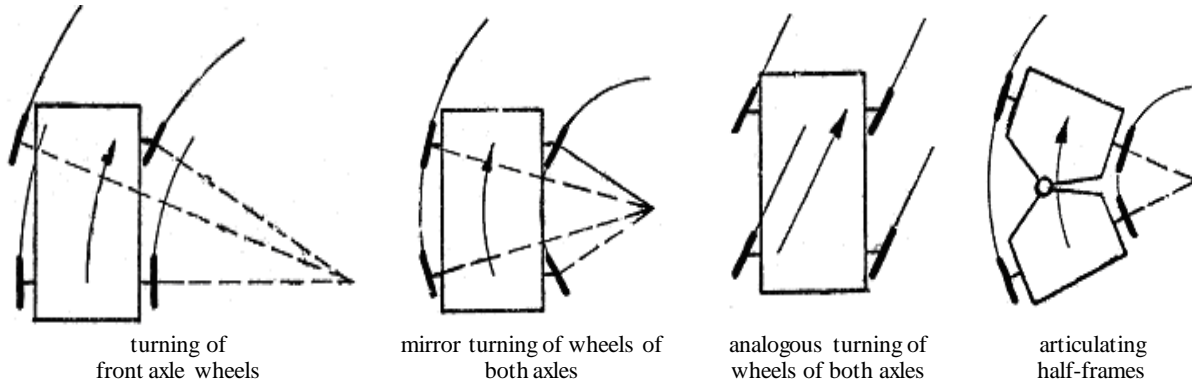
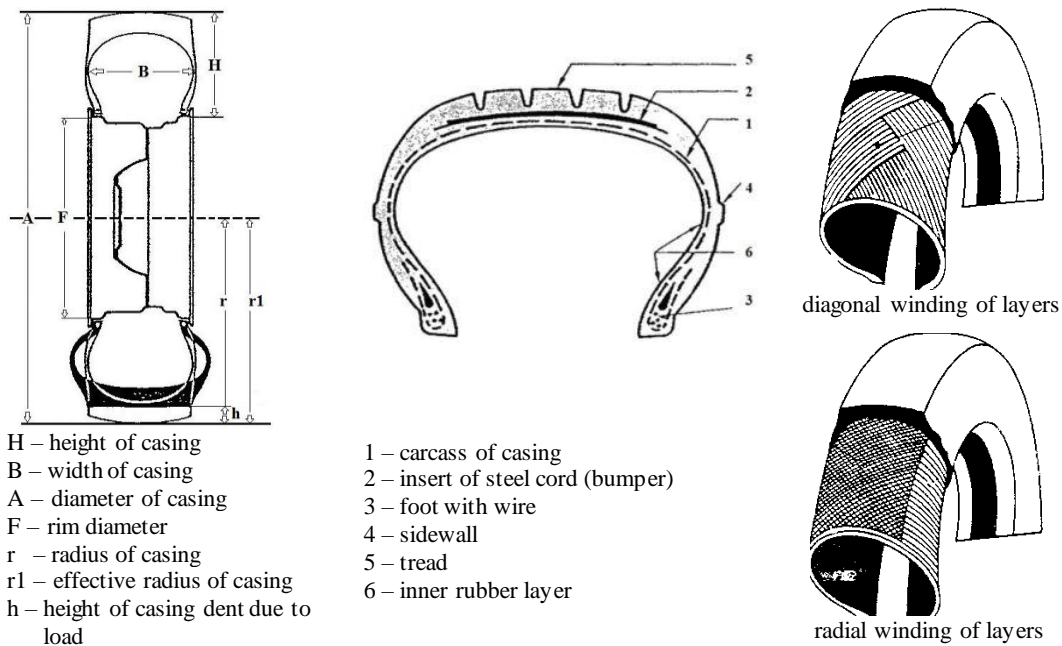


Fig. 10. Variants of directional steering of mobile machines

**Tyres** of wheels of tractors and prime-movers transmit the load of wheel onto the ground, constitute machine supports that contribute to maintaining its stability, and dampen vibrations caused by riding on uneven terrain. Tyres on steering wheels ensure the directional control of machine, tyres on drive wheels transmit force from the combustion engine via transmission gear to the shaft wheel and from the wheel to the ground, thus allowing machine movement and tractive force for pulling loads and driving of adapters. Tyre consists of a textile carcass structure comprising several layers of rubber coated cord fibres mesh that is strengthened and enlarged in the lower part and reinforced at the base using stranded wire. It is further coated with a layer of softer rubber and the tread (protector) on the circumference which is in contact with the ground.

Tyre width and rim diameter are **essential dimensions for tyre specification**. As a rule, they are indicated in inches; however, tyre width may be also given in millimetres. Ordinary dimensions of front non-driven tractor tyres are 6.5-16 and 7.5-16", front driven tyres 9.5-24", rear tyres 14.9-28", 16.9-34", etc. Narrow cultivation tyres used in forest nurseries have an exceptional 12.4-36" dimension. There is further a symbol of tread section consisting of a letter and a digit in the tyre designation. Individual

layers of mesh constituting the tyre carcass may be wound diagonally or radially. **Diagonal tyres** are more rigid and more resistant to rupture; they have, however, a smaller contact surface with the ground as compared to **radial tyres**.



**Fig. 11. Basic characteristics of tyres**

Three basic tread types are used in the tyres of tractors, prime-movers, and forest machines. **Tread with lengthwise rills** for the front steerable wheels of 4x2 tractors is the first one, **agricultural profile** is the second one consisting of diagonal lamellas 5–6 cm in height that has two versions: a classic angular version with the rounded transition edge to the sidewall that reduces soil milling at a slip. The third one is a profile with **angled lamellas**, which is intended primarily for harvesters and forwarders and allows the use of half-tracks on bogie axles because angled lamellas form a ridge in the lengthwise tyre axis, into which cross-bars of half-tracks fit in.



**Fig. 12. Patterns of tyre treads and half-track in tyres with angled lamellas**

Tyre width and inflation pressure influence the value of tyre pressure on the ground. According to that, we divide tyres into **standard** tyres of maximum 450 mm width at >1.5 bar inflation and to **low-pressure** tyres, for which a significantly greater width (minimum 600 mm) and ability to work at <1.0 bar inflation is typical. Using low-pressure tyres is one of prerequisites for increasing the environmental friendliness of forest production because these tyres reduce soil compression and its compaction. (Their disadvantage is, however, a significantly higher price, greater probability of rupture, and more complicated disc structure – in contrast to standard tyres that are fastened to the disc by air pressure, the low-pressure tyres must be held on the disc so that they do not slip on its surface). The increased width of the tyre increases also its carrying capacity.

Parameter		Standard tyre 18.4-38	Low-pressure tyre 23.1-30	Low-pressure tyre 67-34
Outer diameter	cm	175.0	170.5	172.0
Tyre width	mm	470	590	860
Carrying capacity at 0.6 bar inflation	kg	2000	2500	2700
Carrying capacity at 1.6 bar inflation	kg	3000	3900	4600

Table 1. Comparison parameters of standard and low-pressure (wide) tyres

### 1.3 Multi-purpose wheel tractors

Multi-purpose agricultural tractors are energy devices used most frequently both in silvicultural operations and in harvesting in the forestry. A sub-group of wheeled tool-carrying tractors (tool carriers) for the forest nursery practice can be singled out from this machine group.

#### Multi-purpose two-axial wheeled tractors

Tractors have the chassis of frameless self-supporting body; casings of individual machine nodes – of the engine, clutch, gearbox and rear axle – are strengthened to the needed carrying capacity and bolted together. This creates a uniform load-bearing structure. Agricultural tractors came to existence in the 19th century in association with the first attempts at using improved steam engine for agricultural works. The first tractor with the combustion engine applicable in practice was designed in 1901 by designers in the USA. The first half of the 1920s was the beginning of tractor industry in Bohemia, when Škoda factories in Plzeň, Českomoravská - Kolben – Daněk, and Wichterle - Kovařík in Prostějov produced tractors. Zetor became the only representative of Czech tractors on the world market after the end of the Second World War. First Zetor 25 and Zetor 15 were produced in 1946 and the production of a unified tractor series was launched in 1961 as the first one in the world. Its principle was an extensive unification of engine parts as well as of other chassis and body groups. Gradually, Zetor tractors were produced in four unified series.

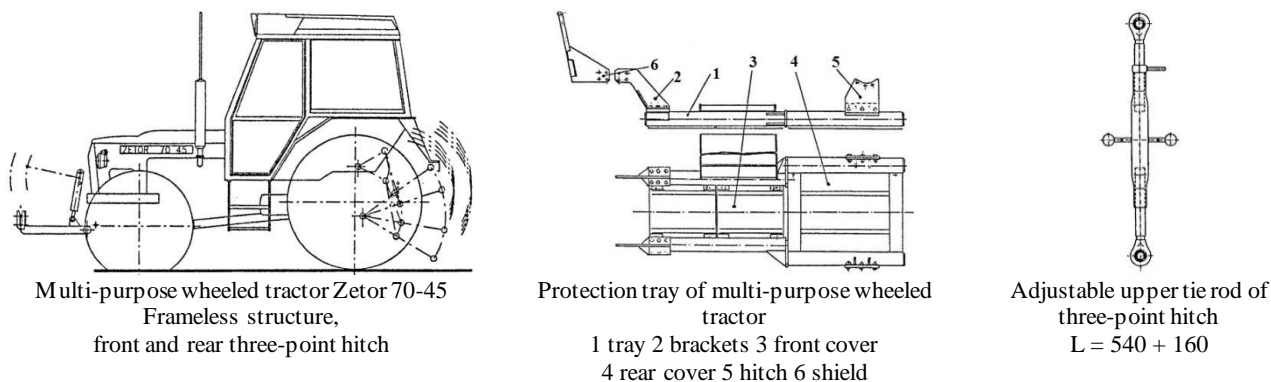
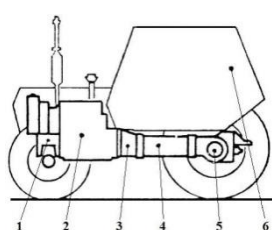


Fig. 13. Multi-purpose wheeled tractor and its equipment

Various super-structures are adapted to tractors and adapters are connected to them to allow their use for choker or chokerless timber yarding and other works. Tractors must be provided with super-structures (winch, shield, platform loader etc.) and adapted (undercarriage protection tray for tractors of unified series I, reinforced supplementary frame of unified series III) for the purpose. Models Z 7245 Horal, Z 7745, Z 8145, and Z 12145 were Zetor tractor types used in the recent period, tractors of older types like Z 6748 and Z 6711 are also still in operation. The **type designation** of Zetor tractors has following meanings: the first two digits indicate the engine power in HP, the second two digits indicate the number of driven axles (45, 48 = 4x4 tractor, 11, 21 = 4x2 tractor).

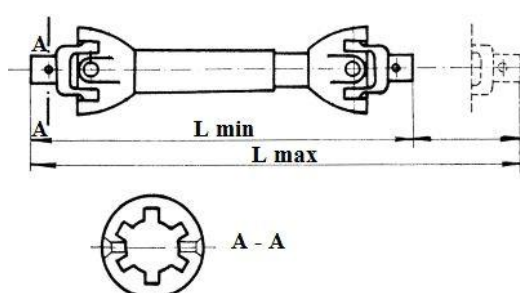
Multi-purpose wheeled tractors Zetor of older concept are equipped with combustion-ignition, in-line, four-stroke, three-to-four-cylinder **engines** with the direct fuel injection, fluid cooled. The direct injection pump is in unattended version. The **clutch** is double-plate, double-purpose with the belleville hold-down spring. The drive clutch is controlled hydraulically and does not need adjusting throughout the service life of the plate lining. The clutch of power take-off shaft has a pneumatic control with the

mechanical coupling. Zetor tractors 5211, 6211, 721.1, and 7711 have swing front axles and telescopic spring-loaded adapters with wheels that facilitate the setting of three different front wheel gauges. Driven front axles of 4x4 tractors are of swing unsprung type. Front wheels are not provided with brakes. **Two-axled tractors with all wheels being driven** make use of all tractor weight for the transmission of tractive force. The slip of tractor wheels is considerably reduced at the same tractive force. The tractor efficiency is higher at higher tractive forces than that of classic types. The **transmission gear** is mechanical. There are 10 + 2 gears, i.e. 5 road gears forward and one reverse, 5 reduced gears forward and one reverse. If desired, it is possible to equip the gearbox with a torque multiplier that increases the driving force on wheels and the number of gears to 20 forward and 4 reverse. Especially in forest nurseries, it is important that tractor gearboxes allow reaching the tractor creeper speed of approximately 100–200 m/hour. Power transmission of **power take-off shaft** is designed in two ways, namely as independent with the standardised speed of power take-off shaft 540 and 1 000 rpm or dependent with the speed of power take-off shaft depending on the gear engaged. The power take-off shaft has replaceable ends, with the profile of 21 splines for 1000 min<sup>-1</sup> and with the profile of 6 splines for 540 min<sup>-1</sup>.



1 swing front axle 2 engine  
3 clutch casing 4 gearbox  
5 final gear with rigid rear axle  
6 cab

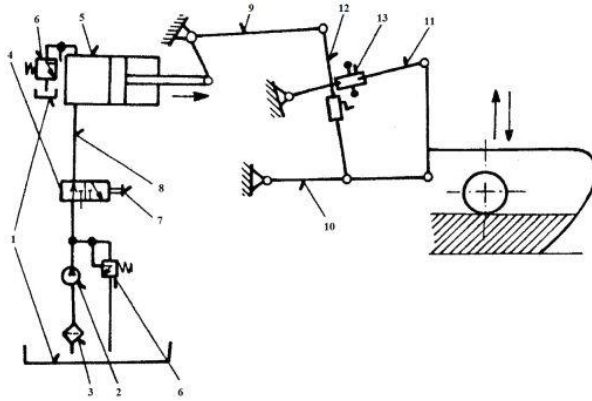
**Fig. 14. Frameless (block) tractor concept**



**Fig. 15. Propshaft for power transmission from tractor power take-off shaft**

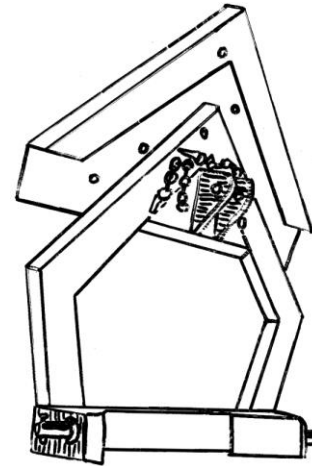
**Process control instrumentation Zetomatic** consists of internal and external circuits. The external circuit ends with three quick couplings of RK 12 type, the pump power output amounts to 32 l min<sup>-1</sup>. An oil cleaner with the paper insert is installed in the hydraulic circuit in the waste branch of the internal circuit. Lower tie rods of the **rear three-point hitch** are equipped with telescopic end pieces. The right lifting tie rod of the three-point hitch is controlled from the driver's position in the cab. The lifting mechanism of the three-point hitch is equipped with an internal and possibly also external hydraulic cylinder to increase the total lifting force. The three-point hitch may be provided with a quick hanger to facilitate the coupling of adapters. The three-point hitch can operate in three regulation modes: **Power regulation** of the hitch consists in regulating force in pulse tie rods of the three-point hitch of the tractor, which it aims to maintain at a constant value. Power regulation in the ploughing tractor reacts to the change of plough resistance so that it partly lifts or sinks the plough with the objective to maintain a constant force. If the soil homogeneity changes, an unwanted change of ploughing depth may occur. On the contrary, at ploughing with a mounted plough on a plot with an uneven surface, power regulation reacts to unevenness's and ploughing depth and balances the ploughing depth fluctuations. **Position regulation** automatically maintains the arms of lifting gear in a position adjusted by the operator. A regulation process is induced upon a change in the position of mounted tool, which adjusts the arms of the lifting gear to the originally set position. A **front three-point hitch** and a **front power take-off shaft** are fitted on a special demand. They are intended for coupling agricultural machines and tools mounted frontally. A **protection tray** for Z 7045 and Z 7245 (there are obviously protection trays for many other tractors, too) is a special accessory of tractors used as a safe cover of the lower tractor part at carrying out mechanized silvicultural operations in harvested stand areas with stumps left behind. The tray is a weldment, main parts of which are two longitudinal tubes connected in the central and rear parts by crossbars. A **complete shield** is a separate part of the protection tray, which is bolted to the tractor at its front. It protects the mask and the radiator against damage caused by penetration of stubs or branches. It preserves the possibility of fitting the front weight and allows access to headlamps and the front mask cover.

Currently, the Zetor Company delivers **multi-purpose tractors of new concepts** that are comparable with trends of other world's manufacturers like New Holland, Fendt, John Deere, Massey Ferguson, etc. These tractors are characterized among others by super charged engines with up to six cylinders, controlled injection, multi-stage reversing gearboxes, engaging gears under load, electronic systems, significantly higher pressures in hydraulic systems (up to 200 bar), and high ergonomic comfort of cabs.



1 tank 2 hydrogenerator 3 cleaner 4 distributor  
5 single-acting linear hydraulic motor 6 relief valve 7 control levers  
8 piping 9 main lifting arm 10 lower tie rod 11 buckling tie rod  
12 connecting tie rods 13 sleeve nut

**Fig. 16. Hydraulic systems of the tractor**



**Fig. 17. Quick hanger**

**New Zetor products** include an economic Majot series of multi-purpose wheeled tractors. Tractors with the drive of 2 as well as 4 wheels have 3- and 4-cylinder engines, power outputs from 33 to 57 kW, and modern appearance similar to the more sophisticated Super series. The tractors are available in versions with/without the cab. Zetor Proxima is the latest series. The design is related to Forterra tractors and harmonises with shapes of safety cab. The tractors are equipped with a new series of Zetor engines that comply with international emission and exhalation standards EURO II, EPA II, Tier 6. The engines achieve the torque exceeding 35%. They are equipped with balancing units and equipment for winter starts, and they can use all Bio-fillings. The mechanical gearbox with 20 + 4 gears is fully synchronised, with the speed of power take-off shaft 540, 540E, and 1000 min<sup>-1</sup>. Extended periods of oil replacement favourably influence the economy of operation. The rich equipment can be further extended with a wide range of optional accessories. The Zetor Forterra series includes middle-class tractors offered in power outputs from 60 to 88 kW. The new design of the safety cab is common with the Super series. It is provided with many technical advantages and optional accessories, for example it contains the EHR Bosch motor, engine with the starting equipment for very low temperatures and balancing units, 24-stage reversing gearbox, etc.

### **Emission limits for engines**

Emission standards EURO have been in place since 1992. They are mandatory and applicable in all European Union countries and they lay down what **maximum quantities of harmful pollutants may be contained in exhaust gases of road vehicles**. Emission standards monitor and regulate amounts of carbon monoxide (CO), hydrocarbons (HC), nitrogen oxides (NOx), and solid particles (SP) per one travelled kilometre.

New EURO emission standards have been published since 1992 at regular intervals of 4 to 5 years and are numbered in the ascending order. Standards numbered in Arabic numerals are used for passenger cars and light duty vehicles, emission standards for buses and heavy trucks are designated in Roman numerals.

Each new emission standard is stricter and pollutant limits are lower. It applies to newly marketed vehicles only, however. Currently, 2014 EURO 6 is the latest emission standard that was innovated and made even more strict in 6c respectively 6.2 versions.

European **emission standards for diesel engines of agricultural devices** were elaborated in several levels known as Stage I to Stage IV. The first European legal regulations regulating emissions of working equipment Stage I/II were published on December 16<sup>th</sup>, 1997. It was the directive 97/68/EC. Limits for diesel engines were introduced in two stages: Stage I became valid in 1999 and Stage II was implemented from 2001 to 2004 depending on the engine power. These regulations covered a wide range of machines for construction, agricultural, and other purposes, while all these machines had common regulations. Deadlines for transposing (Directive 2000/2S/EC) were different for agricultural and forest tractors only. **Emission standard of Stage IV for tractor engines of 75 – 173 HP** (by way of illustration, it applies to approximately two thirds of the Zetor brand production) became valid in 2014. It is characteristic for Stage IV standard that the limits of nitrogen oxide (NOx) with the 0.4 g/kWh value are very strict. A combination of active DPF filter (filter of solid particles) and SCR (selective catalytic reduction based on applying solution of urea (trade name AdBlue) to the flow of exhaust gases) technologies is used to achieve them. This chemical catalyst and a sufficient temperature reduce the surplus NOx into water (H<sub>2</sub>O) and nitrogen (N<sub>2</sub>).

**Stage V** is a further stage of emission standards development for engines used in new machines and vehicles intended for the operation in off-road conditions. The Stage V standard became applicable for engines **to 56 kW** and **over 130 kW** in 2019 and for engines of **56 - 130 kW** power outputs in 2020. In contrast to previous standards, **Stage V** applies also to diesel engines with the power output **less than 37 kW** (50 HP) and those with the power output **over 560 kW** (760 HP) for the first time. The emission level of Stage V continues further in reducing the quantity of solid particles and nitrogen oxide NOx content. The main difference of **Stage V** as compared to previous standards is that it **determines the limit quantity of solid particles for the whole range of engine power outputs for the first time**. It means that solid particles filters will be mandatory everywhere. The new standards will apply for traditional construction, industrial, and agricultural machines, for material handling, but also for mobile machines with the constant running speed like generators on wheeled trailers for example.

Permitted emissions [g/kWh]	Carbon monoxide		Unburned hydrocarbons		Nitrogen oxides		Solid particles		Number of solid particles per 1 kWh
	Stage IV	Stage V	Stage IV	Stage V	Stage IV	Stage V	Stage IV	Stage V	
Power output [kW]									
under 8	-	8,00	-	7,50	-	7,50	-	0,400	-
8 - 19	-	6,60	-	7,50	-	7,50	-	0,400	-
19 - 37	-	5,00	-	4,70	-	4,70	-	0,015	1×10 <sup>12</sup>
37 - 56	-	5,00	-	4,70	-	4,70	-	0,015	1×10 <sup>12</sup>
56 - 130	5,00	5,00	0,19	0,19	0,40	0,40	0,025	0,015	1×10 <sup>12</sup>
130 - 560	3,50	3,50	0,19	0,19	0,40	0,40	0,025	0,015	1×10 <sup>12</sup>
over 560	-	3,50	-	0,19	-	3,50	-	0,045	-

Source: <https://dieselnet.com/standards/eu/nonroad.php>

**Table 2. Comparison of Stage IV and Stage V emission standards for off-road engines**

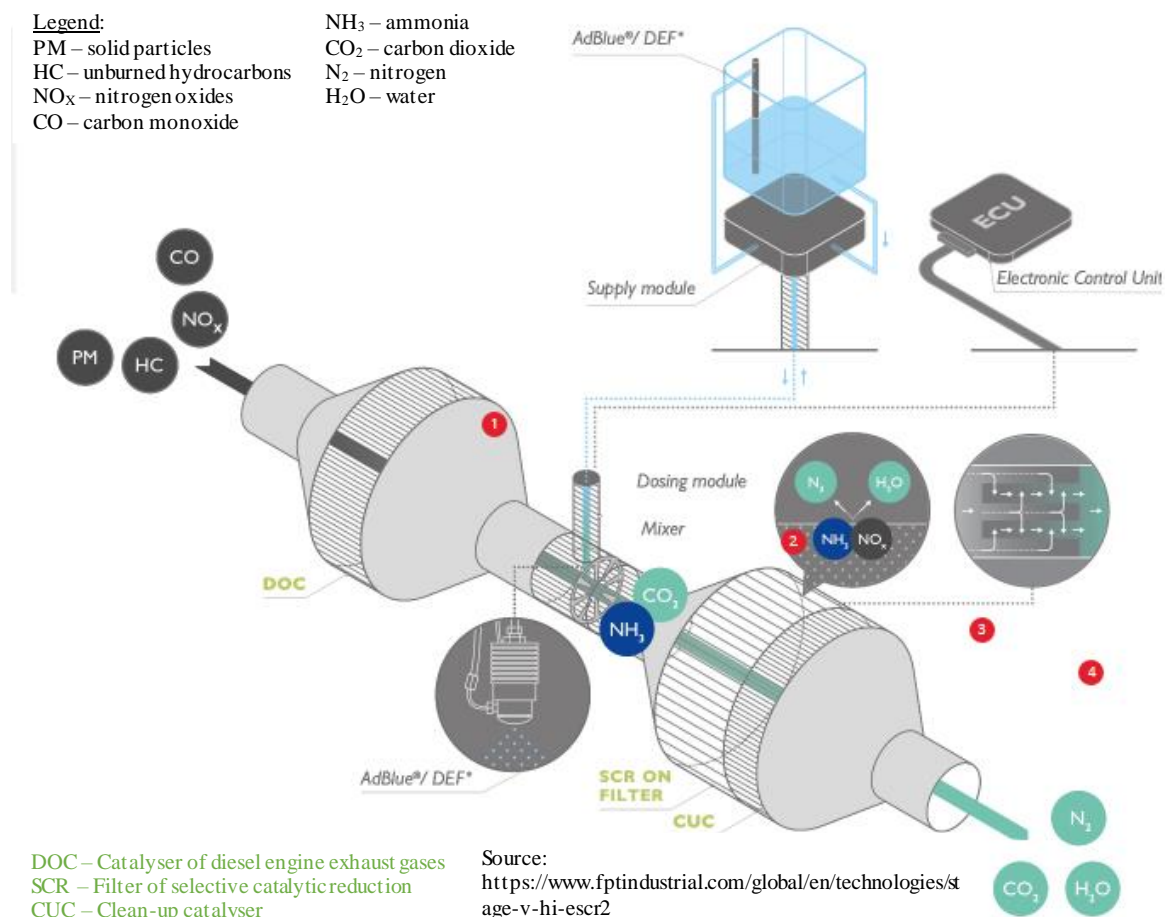
### Tool-carrying tractors

This is a group set aside from multi-purpose wheeled tractors. Tool-carrying tractor (**tool carrier**) is a self-propelled energy device, to which various kinds of non-driven as well as driven tools (adapters) are aggregated. Tools are driven using the power take-off shaft, compressed hydraulic oil or the travel of machine. They are differentiated according to

- chassis structure** to wheeled, caterpillar, portal, rail etc. carriers
- structure of load-bearing part** to frame, central tube, suspended, and bridge carriers
- variability of use** to multi-purpose and single-purpose carriers.

In forestry, tool carriers are used in nurseries mainly. They are four-wheeled mostly, caterpillar rarely. It is their typical characteristic that the engine and the gearbox are located in the rear part under the driver's seat and the front part consists of an uncovered bearing part (frame or central or combined with

hydraulic hitches for fastening tools). Most tools are fastened between the front and the rear axles and therefore the **carriers are characterised by good visibility of tools from the driver's position**. Engine power of carriers is lower than that of wheeled tractors (20–25 kW in case of common types, so that they are suitable for activities that consume less energy, but require accuracy at work (weeding and loosening, sowing etc.). The tool-carrying tractor **RS-09** was imported to our country from the then German Democratic Republic in the early 1960s. It is also exceptional by being one of the oldest machines in our forestry. Even though its production ceased in 1970, it is still used in many forest nurseries. It is characterised by central tool beam, rear three-point hitch, and external hydraulic circuit. TN4-K2-10 tool carrier with a frame member was produced in our country shortly in the 1960s. Currently, foreign tool-carrying tractors from Slovakia, Austria, Germany, Denmark, Russia etc. are available to forest nurseries.



**Fig. 18. Principle of the operation of equipment for reducing emissions of combustion-ignition engines by mixing exhaust gases with urea**

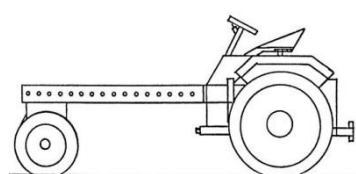
**Portal tool carriers** are characterised by high clearance (1.0–2.0 m), which allows them to work in high-grown plantations. In forestry, they can be applied in raising the grown-up planting stock, large-sized plants, semi-saplings or saplings and in the production of Christmas trees. Rather at a theory level and for the sake of completeness, mobile tool carriers of bridge type are presented as a progressive equipment. **Bridge carriers** represents a large engagement unit, generally with two chassis, that moves using two consolidated tracks or rails. The chassis spacing may be 20 and more metres. A load-bearing member carrying exchangeable working elements or whole adapters is placed on the chassis. The equipment resembles some irrigation systems used in forest nurseries.



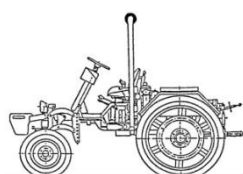
Type	Country of origin	Engine power kW	Speed min. km.h <sup>-1</sup>	Speed max. km.h <sup>-1</sup>	Crossbeam	Use
RS-09	German Democratic Republic	19.0	0.9	15.5	R, Rh	M
Schifter M 18	Federal Republic of Germany	13.6	2.0	28.0	F, Rh	M
Schifter M 28	Federal Republic of Germany	21.2	1.5	24.0	F, Rh	M
Schifter M 33	Federal Republic of Germany	25.0	1.5	24.0	F, Rh	M
MT6-091	Slovakia	13.0		15.0	R	M
Agron 22	Slovakia	22.0	1.3	24.0	Fh, Rh	M
Quicktrack	Austria	11.0	1.1	14.0	F, Rh	M
Quicktrack	Austria	11.0	0.1	12.0	F	T
Egedal M	Denmark	10.5	0.1	6.0	F	Š
Egedal XMAS 500	Denmark	37.5	0.1	18.0	F, Fh, Rh	U, XT

R – central crossbeam, F – frame member, Fh – front hitch, Rh – rear hitch, M – multi-purpose, T – transplanting, XT – Christmas trees

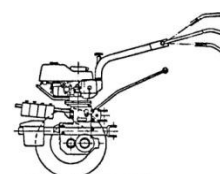
**Table 3. Essential parameters of selected types of tool-carrying tractors**



Tool-carrying tractor RS 09



Tool-carrying tractor Agron 22



Single-axle tractor Agzat

**Fig. 19. Tool-carrying tractors**

**Fig. 20. Single-axle minitractor**

## 1.4 Single-axle tractors

Single-wheel 1K1 (1 - motor spading machines) and two-wheel 2K2 (2 – motor robots) tractors belong to the group of single-axle tractors. The tractor is steered by handlebars, on which all controls are located. A worker either walks behind the tractor or sits on an auxiliary chassis. The tools are located in front of the axle or behind it. The single-axle tractors are equipped with the light spark-ignition or combustion-ignition engines, mostly of power output 3-4 kW, to a lesser extent of higher power outputs. A number of manufacturers currently produce single-axle tractors and accessories in the Czech Republic and in other countries. The **UNI system** represents a series of machines with the single-axle mini-tractor to which adapters for ploughing, cultivation, mowing, turning, transport etc. are coupled. The Jikov engine type has 5.15 kW power output, the weight of pulling unit amounts to 168 kg. Cylinder engine capacity is 218 cm<sup>3</sup>, number of gears 4 + 2. Model **Agzat 100** is provided with then engine of 3 kW power output and capacity of 100 cm<sup>3</sup>. It is intended to drive various aggregates - e.g. for soil tillage, mowing etc. The **Vari system** has the engine of 5.5 kW power output and four basic types of gearboxes, to which various working equipment is coupled. Single-axle tractors can be used in smaller forest nurseries, for digging holes, at mowing plantations etc.

## 1.5 Caterpillar tractors

Energy devices on caterpillar chassis have endless steel tracks placed on pulleys between the travel wheels and the ground. Tracks serve as a travel system. The total weight of the caterpillar means is used to achieve high tractive forces. Caterpillar chassis have a high capability of adhesion (even more than 100%) and thus the maximum engine power can be used at full without excessive slip. They are used for the heaviest works, primarily in soil tillage under conditions when low specific pressures on the soil (0.3 – 1.0 bar, tracks for low bearing soils and reclamation works are up to 1 m wide) and high tractive force or a high gradeability are required. Nowadays, especially dozers and also some logging machines are equipped with the caterpillar chassis. Genuine caterpillar tractors are currently used only rarely in the Czech forestry. **Caterpillars have a frame** as well as **frameless chassis** and the running gear is suspended in them. It consists of two tracks, two track driving wheels, spring-loaded travel carriages with pulleys, bearing pulleys, and guide blocks (tension pulleys). Tracks consist of track links connected by pins. Steel tracks may be provided both with rubber and plastic components. It is one of the disadvantages of caterpillar chassis (steel ones in particular) that they can damage the surface of paved roads especially when turning, which occurs through the mutual speed change of the tracks. The most recent caterpillar tractor for agriculture is the Caterpillar Challenger 65 with the 200-kW engine power, rubber tracks of 62 cm in width, 3.3 m<sup>2</sup> contact area, and 42 kPa specific pressure on the soil.

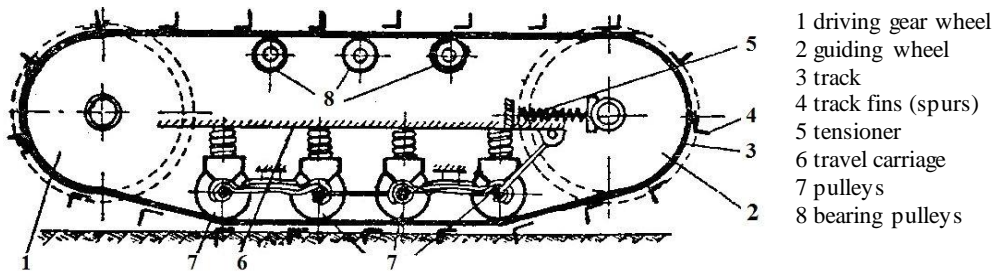


Fig. 21. Schematic of caterpillar travel system

### 1.6 Special forest wheeled tractors and prime-movers

The basic concepts of special forest wheeled tractors and prime-movers used in our conditions were very similar: they have a two-part frame connected by a central joint, the directional control is provided by front and rear half-frames articulating around a vertical pin using hydraulic cylinders and steering wheel distributor; all four wheels are of the same size, permanently driven, and axles are equipped with differential locks, which pre-determines good tractive properties of these machines, the rear axle is fixed, the front axle may be of swinging type or the swing of the front and rear half-frames is ensured by the axial joint. The machines are provided with the driver's safety cab and are characterised by a higher clearance (50 cm as compared to 30 cm of multi-purpose wheeled tractor) and improved stability which allows them to move in off-road conditions with inclinations up to 40 %. Special forest wheeled prime-movers differ from special forest wheeled tractors in being equipped with mechanisms for timber yarding by dragging (winches, grapples, skidding shields, clam bunks) from the manufacturing plant and are not suited for easy and fast coupling, decoupling, and driving various adapters normally. Some contemporary constructions of special forest wheeled tractors are designed for more universal use, however. It is possible e.g. to remove the skidding shield and thus to expose the tie rod of three-point hitch or stack hitch, and of the hydraulic oil supply and torque from power take-off shaft.

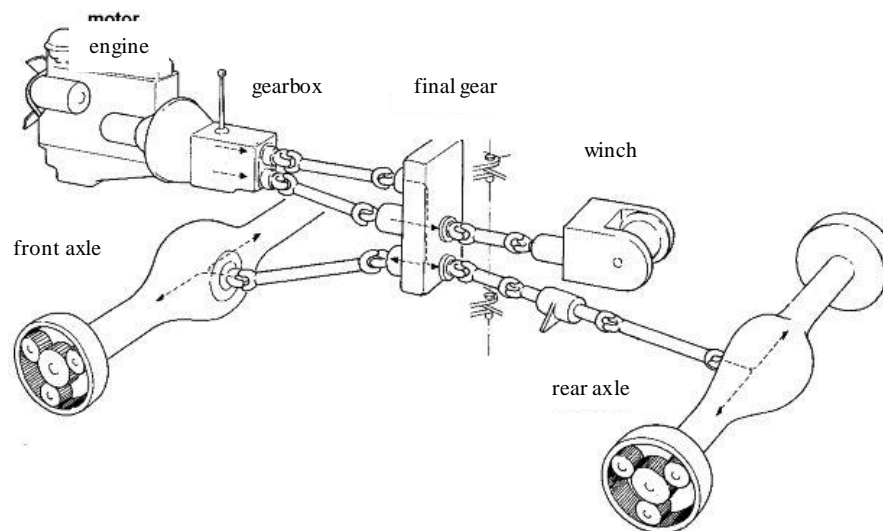


Fig. 22. Distribution of power output to wheels and winch of special forest wheeled tractor

#### Forest wheeled prime-mover LKT-81

The front axle of swing type, engine, 5 stage gearbox, and 2 stage downward final gear are located in the front part. Torque drive from the final gear to the front and rear axles is provided by propshafts. A hydraulically driven winch with two drums, friction multiplate clutches, and caterpillar brakes controlled electrical-pneumatically is mounted in the rear part. The rear part includes a fixed skidding shield with a trestle for accommodating cables. A hydraulically controlled ramp-loading share is mounted at the front part. It is intended for timber yarding using a coil winch, piling timber in stacks, evening stack fronts, simple earth-moving works, and towing trailers up to 3000 kg.

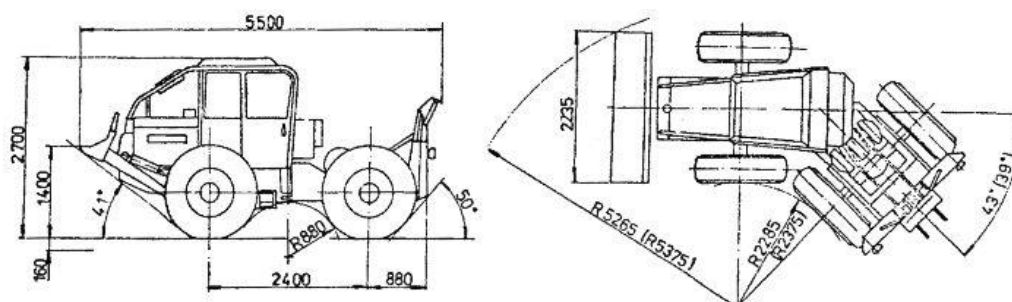


Fig. 23. Forest wheeled prime-mover LKT-81

### Forest wheeled prime-movers LKT-90

Prime-movers are designed as modular, i.e. the basic machine corpus is identical while individual types differ in equipment and purpose. The engine is pressure charged, four-cylinder, with direct fuel injection. The 3 HPR 75.C gearbox is a three-stage, hydro-mechanical, planetary, reversing type with the power shift, and a possibility of automatic gear-shifting and converter locking. The fluid converter has 2.6 gear ratio. A hydrogenerator is fitted in its section, which provides the supply of pressure oil for gearbox control and lubrication. The power output can be taken from the basic planetary gearbox either through the accessory gearbox to the winch or through the planetary gears to the accessory gearbox. This accessory gearbox provides torque to the winch of LKT 90 A, LKT 90 B and to the power take-off shaft of LKT 90 P through the claw clutch and propshaft. The front axle drive is taken from the front bottom shaft of final gear and the rear axle drive is taken from the rear bottom shaft. The front axle is fixed, the axial joint provides for the swing of the front and rear parts.

**LKT 90 A – prime-mover** is intended for timber yarding using a winch, piling timber on stacks, evening stack fronts, simple earth-moving works and towing of unbraked trailers up to 3000 kg. **LKT 90 B – prime-mover** is intended for chokerless timber yarding using a grapple on the hydraulic jib, it is equipped also with a line winch. It can be used for pulling trees through the delimiting machine, too. **LKT 90 P tractor** is equipped with 3-point hitches and power take-off shafts in the rear and in the front and is used to carry and drive suitable adapters and to tow unbraked trailers of up to 3000 kg weight (up to 7000 kg in case of braked trailers).

	LKT 81	LKT 81 T	LKT 90 A	LPKT 40	LKT 82
Design weight (kg)	6 730	7 065	7 040	3 500	9 500
Engine power (kW)	60	75	75	46	93
Front axle load (%)	60	60	65	60	60
Number of winch drums	2	2	2	1	2
Tractive force of winch (kN)	60	70	80	40	100
Pressure in hydraulics (MPa)	16	16	16	35	35
Gears	2x(5+1)	2x(5+1)	2x3	hydrostat.	hydrostat.

Table 4. Technical parameters of some LKT machines

### Forest and agricultural wheel prime-mover LPKT 40

This device is equipped with a four-cylinder engine and hydrostatic drive power output using the regulating piston pump SPV 22 and non-regulating piston engine SMF 22. The final gear is of two-stage design. Axles are fixed. The machine is equipped with an axial joint that allows the machine wheels to copy the terrain surface by turning both half-frames axially against each other. The winch with one drum is hydrostatic. The machine is provided with a ramp share, foldable shield mounted on the rear 3-point hitch, line trestle, and 0 - 1000 min<sup>-1</sup> power take-off shaft.

**LKT 82** is currently a representative of modernisation in the areas of ergonomics and performance of forest machines aiming at the using of progressive technologies of timber harvesting and yarding. It is built on the chassis of LKT 81 type series and the super-structure consists of a foldable shield, share, winch, and hydraulic crane as an option. All controls are electrically (electrical-hydraulically) controlled. A swivel workplace allows flexible work and travel with the machine. The high engine power, safety cab of low noise level, emergency servo-steering of the machine, automatics of travel with

inch-control, tyres with increased carrying capacity and passability through heavy terrains contribute to the machine usability and user-friendly operation. Other machine equipment can be supplied as an option, for example: thermostart, air-conditioning, rear 3-point hitch with floating position and power take-off shaft, hitch for a trailer, tyres of different widths, light ramp, clam bunk for rear shield, feller head for felling trees up to 25 - 40 cm in diameter, modular cableway system on the rear shield, remote control for required machine functions, etc.

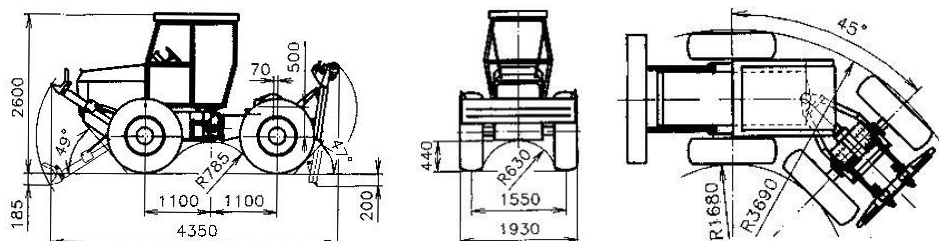


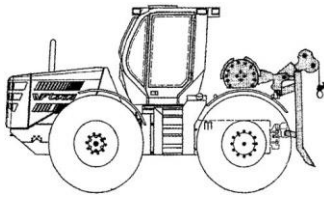
Fig. 24. Forest and agricultural wheeled prime-mover LPKT 40



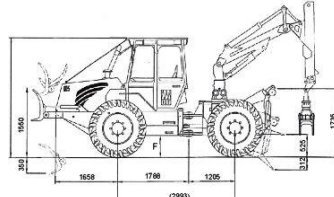
Fig. 25. Forest and agricultural wheeled prime-mover LPKT 40

### Other selected types of special tractors and prime-movers

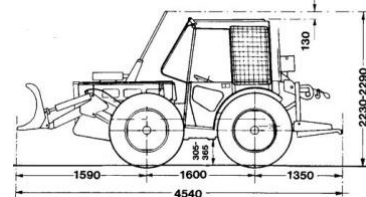
German machines WF trac 1300, 1500, and 1700 with the engine power from 100 to 130 kW, weight of 8500 kg, articulated steering, and maximum speed of 50 km/h are examples of high-performance special forest wheeled tractors. It is possible to couple adapters for various purposes including timber yarding to these tractors. High travel speed allows using them also for a long-distance transport. Machines of Holder brand, e.g. type Cultitrac A 55F having 31 kW engine power, weight of 3 000 kg, and maximum speed of 20 km/h are examples of smaller special tractors of articulated construction that can be used for improvement felling. LMV Carraro 7700 Forst with the 47-kW engine power is another machine of this class. German **HSM Hohenlohe-Waldenburg Company** provides a very rich offer of special forest wheeled tractors. In recent years, their tractors are typically equipped also with a grapple having the reach of ca. 6 m intended for handling timber in the stand and at the roadside landing, standard adapters for timber yarding (platform loader, winch, skidding shield). Types HSM 704 (85 kW), HSM 805 (100 kW), and HSM 904 (136 kW) in many variations belong to these machines. The Welte Company offering types W 115 (84 kW), W 170 (128 kW), W 180 (128 kW), and W 210 (157 kW) selected a similar concept of its products. **John Deere Company** products, e.g. types **540G-III** (engine power 96 kW, weight 10300 kg, 140 kN winch), **548G-III** (engine power 96 kW, weight 10600 kg, provided with a grapple) are typical prime-movers for yarding both small- and large-diameter coniferous and broadleaved timber. High performance models include **John Deere 640G-III** supplied with a winch, **648G-III** supplied with a grapple, and **848G-III** as the largest type delivered with a grapple.



**Fig. 26. Special forest wheeled tractor WF trac**



**Fig. 27. Forest wheeled prime-mover HSM 805**



**Fig. 28. Small special forest wheeled tractor Holder A 650 F**

Various energy devices were characterized above according to their design properties. Their adapters for individual activities, technological use, and suitable working procedures as well as forwarders will be described further in chapters with the respective thematic focus.

## 2. Basic quantities of tractor mechanics

Tractor mechanics deals with monitoring the static as well as dynamic physical quantities connected with the tractor design (these parameters may be monitored analogically in other mobile means, too), internal and external conditions of tractor operation. It substantiates them theoretically and deals with the consequences of stationary and dynamic effects in the respective environments. The dimensional and weight quantities of the tractor, the generation and transfer of energy from the engine to the running gear and the efficiency of this transfer, slope stability, driving properties and resistances, tractive properties, tractor travel impact on the ground, etc. may be monitored within the tractor mechanics. We will deal with three areas of tractor mechanics that are directly related to its operational use

- dimensional features and stability of tractor on the slope
- tractive capabilities of tractor
- basics of terramechanics.

### 2.1 Tractor dimensions and stability on the slope

The main dimensions of tractor are: total length, width and height, clearance, axle base, wheel track and **gravity centre position**. The centre of tractor gravity is an imaginary point, in which the whole tractor weight is concentrated. The vertical trajectory of its weight, a so-called midline, passes through the centre of gravity. The gravity centre position has principal influence on the tractor static as well as dynamic properties, influencing its tractive capabilities, size of attached burden, individual wheel loads as well as tractor stability on the slope. The location of tractor gravity centre is characterized by its horizontal and vertical coordinates. Following coordinates determine the centre of gravity in the four-wheel tractor:

- **longitudinal horizontal coordinates  $a, b$**  – determine the distance of gravity centre from the point of front wheel contact with the ground (coordinate  $a$ ) and the distance of gravity centre from the point of rear wheel contact with the ground (coordinate  $b$ ); the sum of both coordinates gives the axle base value  $L$ ;  $L = a + b$
- **lateral horizontal coordinates  $d, c$**  – determine the gravity centre position with regard to the wheel track – however, we consider the tractor to be symmetrical in practice and the centre of gravity is assumed in the tractor symmetry plane; that is why we do not calculate these coordinates.
- **gravity centre height  $h$**  – the height of tractor gravity centre of gravity (without attached adapters and burdens) above the terrain surface is determined by the manufacture. However, the position of tractor gravity centre changes - shifts - depending on attached adapters and burdens. Therefore, it is reasonable for operational needs to know the principles of ascertaining its current position. Procedures of technical mechanics are used to find the gravity centre position as well as in further related calculations.

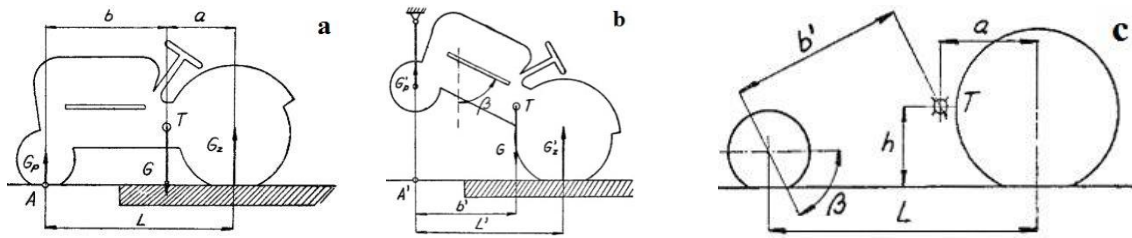


Fig. 29. Determining the position of tractor gravity centre by the method of weighing and measurement

**Types of tractor axle loads**

- **actual** in given conditions (resulting from actual effects of all factors: tractor weight, adapter weight, method of adapter coupling, towed burden, direction of travel in relation to slope inclination, etc.)
- **maximum** resulting from the tractor structural limits and related to given conditions, e.g. to the speed
- **minimum** related above all to meeting the condition of manoeuvrability, min. 20% of total tractor weight must act on the steerable axle according to legal regulations.
- **nominal** (tractor itself).

**Tractor stability on the slope** (this is generally applicable to all mobile means) expresses the tractor capability to move and stand on a slope without the risk of roll-over. It is expressed as an admissible slope gradient in relation to the tractor movement direction. It is an important quantity, to which the tractor safe operation is related, a quantity, the instantaneous value of which depends on many factors: position of tractor gravity centre; centre distance and wheelbase; type, condition and pressure of tyres; chassis design; movement direction (perpendicular to the slope and against it, on contour line, obliquely to the slope); turning (effect of centrifugal forces); travel speed; technical condition (i.e. of brakes); performed activity; load type; slope inclination; soil cover, soil condition; microrelief of terrain; weather, etc. It is therefore appropriate to understand at least the basic principles of determining the stability parameters and to apply them under specific conditions.

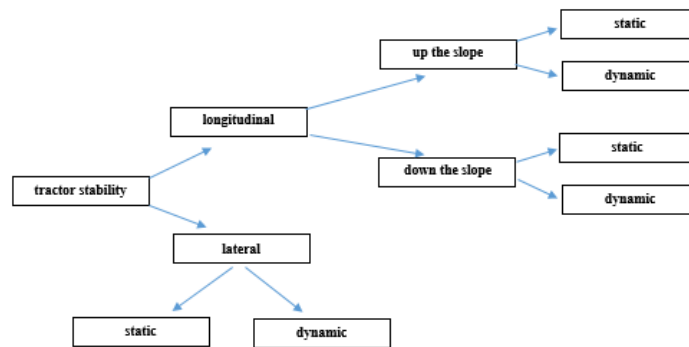


Fig. 30. Distinction of tractor stability forms

Stability on the slope is derived from **critical slope gradient** being the inclination at which the vehicle gets from the stable condition to the limit condition of unstable balance at a certain direction of travelling on the slope. This situation occurs, if the tractor median intersects the flip line, i.e. the line around which the tractor rolls over at reaching and exceeding the critical inclination and losing stability. The position of this line depends on the machine travel direction and on the structure of its chassis. **Critical angle** is determined using the trigonometric function tangent (or arc tangent) which is given by the ratio of respective horizontal coordinate of gravity centre and its height. The critical angle of slope inclination is directly related to the static stability; therefore, we assume that the tractor is at rest when the angle is determined. Such a situation is in fact unrealizable in real conditions, but it is the basis of all further calculations leading to the determination of dynamic stability parameters of a moving tractor.

**Problem of lateral stability of tractors with articulated steering**

The centre of gravity shifts to the outer edge of a circular trajectory at the turning of tractors and prime-movers with articulated steering, which become more unstable compared to the straight travel. The chassis articulation also causes a change of distance between the tyre contact points, which results in decreased stability, too. This has an especially adverse effect on steeper slopes when a tractor travelling at a right angle to the contour turns in the direction of contour line or turns in the opposite direction, or when a tractor travelling along the contour line turns up the slope. Critical situations of impaired stability occur in combination with passing obstacles (stumps) or terrain unevenness's. A loss of stability of machines with the articulated chassis may occur also when timber is pulled by winch line – this is why the tractor should be straightened before the line pull and the line axis should correspond approximately to the longitudinal axis of the machine.

**2.2 Traction capabilities of the tractor**

The driving force of tractors is obtained from the machine torque or from the engine power that is transferred by the transmission gear to the drive wheels. A part of this power is consumed to overcome machine driving resistances (inner machine resistances, wheel rolling resistance, losses caused by wheel slipping, resistance caused by slope inclination, air resistance) and the rest is used to develop tractive force for pulling loads and work adapters, to drive working gears of the adapters or to accelerate the motion.

The value of force which the drive wheels are able to transfer onto the ground and which can be used for active tractor motion depends on two quantities: on **adhesion tractor weight  $G_A$**  and on efficiency of this transfer - on adherence which is the expression of force transmission efficiency by the adhesion coefficient  $\mu$ . **The adhesion coefficient  $\mu$**  is related to the maximum value of tangential force on the wheel circumference when the wheel of given design features (of certain tyre type and wear) begins to slip on the ground at the given adhesion weight. The adhesion weight of tractor is a vertical component of weight attributable to drive wheels.

Base	Condition	$\mu$	
		Tyres	Tracks
Asphalt	dry	0.7÷0.9	
	wet	0.5÷0.7	
Concrete	dry	0.8÷1.0	
	wet	0.5÷0.8	
Road	compacted snow	0.2÷0.4	0.6÷0.8
Winter road	dry	0.8	0.8
	wet	0.7	1.0
Virgin soil	dry	0.7	1.0÷1.2
Meadow		0.6	0.7
Sand		0.3÷0.4	0.3
Field	stubble	0.6	0.8-1.0
Skidding line	muddy	0.1	

Table 5. Some values of adhesion coefficient  $\mu$

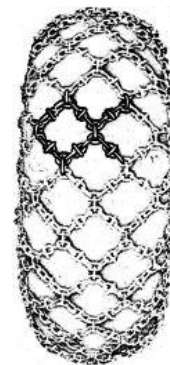


Fig. 31. Anti-skid chains

**Adhesion force  $F_{TA}$**  is therefore different in 4x4 tractors (greater by approximately 1/3) compared to 4x2 tractors. The adhesion coefficient  $\mu$  is a dimensionless number that is lower than 1.0 in an absolute majority of cases. Only when tracks are used on a so-called virgin soil (untreated, settled soil reinforced with small plant roots), it may even reach a value up to 1.2 (Table 5.). In practice, the adhesion weight of tractor can be increased by filling wheels with water containing the addition of anti-freeze agent (e.g. brine or  $CaCl_2$  solution – pure water would freeze in the winter period) using special valves. The wheel filling will also increase the machine stability at the same time.

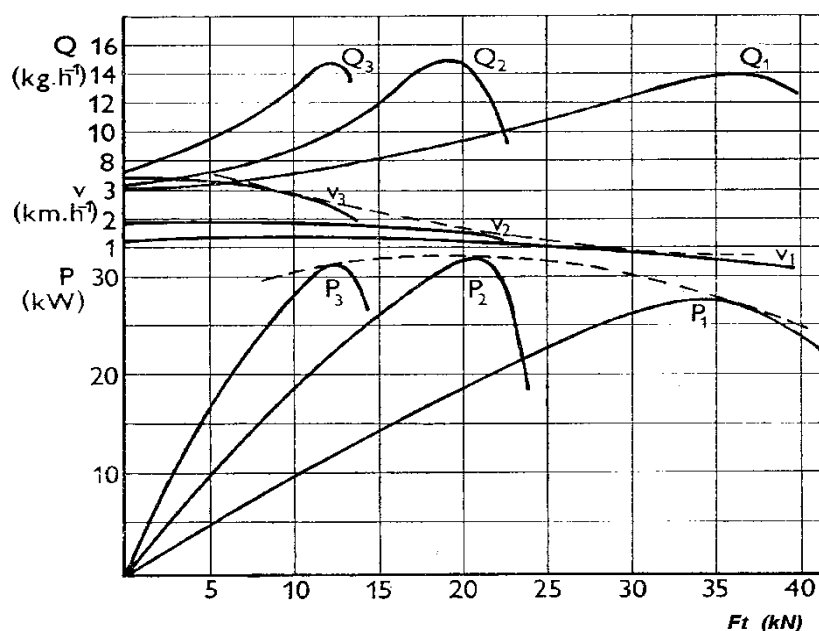
**Off-road and gripping non-skid chains** allow to increase tractor traction capabilities, to reduce slipping and protecting tyres as well as the soil in unfavourable terrain conditions (on snow and ice, in stony terrains etc.). They are produced in a number of modifications; their links use to be provided with

studs and pins improving the grip properties. An increase of adhesion coefficient  $\mu$  unattainable otherwise under the given conditions is achieved by their use.

**Traction characteristics** of tractors specify mutual relationships between traction power outputs, travel velocities and fuel consumption at individual gears. The envelope curve of traction power outputs is a curve of the potential power output and indicates maximum traction power output of tractor for each traction force at the respective working speed. The envelope curve of velocities is the curve of potential velocities and it indicates the highest speeds that the tractor can reach at the corresponding traction force. A tractor of higher traction force is able to tow a bigger load, to climb greater gradients, etc.

Traction force available for certain conditions can be determined relatively exactly using the above-mentioned equations. For practical operational purposes, when a very rough traction sufficiency of the tractor (i.e. its capability to haul a certain burden or adapter, tractor trailer, machine for soil tillage, load timber) is sufficient under given conditions, the **traction force** of the tractor can be **derived for guidance** from

- the maximum traction force of the tractor specified by the manufacturer (taking into account the influence of slope and adhesion conditions)
- the tractor adhesion weight (taking into account the influence of slope and adhesion conditions).



Q fuel consumption, v travel speed, P traction power output, 1,2,3 gears

Fig. 32. Traction characteristics of a forest wheeled prime-mover LKT 82

### 3. Basics of terramechanics

**Terramechanics** is a scientific field investigating phenomena resulting from the contact of chassis of mobile machines with earth and their causes. Knowledge of terramechanics is important both for designing mobile machines and for their operation. It provides information, on the basis of which it is possible to optimise the design in terms of machines structure, to minimize negative consequences of machines operations for the soil, and to improve service life and economic parameters of operated machines possibly from the point of view of machines user. The phenomena arising from the travel of mechanisms on the ground are namely:

- pressures on the base and their spreading
- resistances during travel
- soil compression
- emergence of tracks
- grip properties of travelling mechanism.



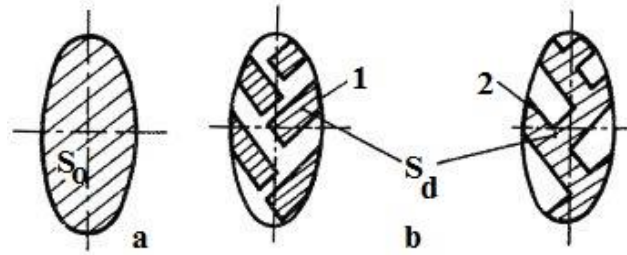
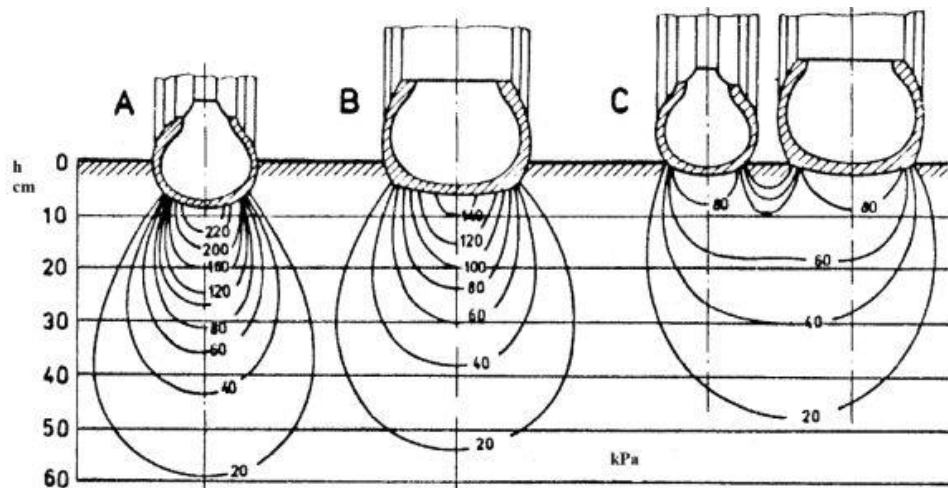


Fig. 33. Tyre bearing surface

The travel assembly (wheel, track) touches the base (ground) with the **bearing surface area**  $S_D$ . The bearing surface area of caterpillar chassis has a rectangular shape and may be easily determined from track dimensions. In the case of tyres, the bearing surface area on the ground is a general term that is specified by a further two terms:

- a) **imprint area**  $S_0$  – total contact area between the tyre and the base bordered by the contour line. On a solid base, the imprint area contour has an approximate shape of ellipse.
- b) **contact area**  $S_d$  – part of imprint area delimited by ledges (strips) of tyre tread that are in direct contact with the base.

Specific pressure is different for wheel at rest, for wheel moving on the hard base as well as for wheel moving on the soft base. The bearing surface area of wheel at rest has a shape of ellipse and pressure distribution takes place symmetrically along its longer axis. The moving machine acts by its weight and dynamic effects.



A - tyre 170-20AW, pressure 0.3MPa, B - tyre 10-18 AW, pressure 0.15 MPa,  
 C – double installation of tyre 170-20 AW, pressure 0.075 MPa and 10-18 AW, pressure 0.075 MPa,  
 h - depth of pressure distribution in soil

Fig. 34. Distribution of pressures caused by a tyre in the soil

On the hard base, the area of the highest specific pressures moves forward in front of the wheel axis by the distance  $a$ . Even a greater asymmetry of distributing specific pressures under wheels occurs at moving on the soft base. The size of bearing surface area  $a$  in front of the wheel axis is greater than the size  $b$  behind the wheel axis. The normal reaction is thus advanced in front of the wheel centre, even though the maximum specific pressure is approximately in the wheel axis. Pressures in the soil caused by the travel of wheeled means with tyres spread into a considerable depth as well as to a distance from the wheel symmetry axis. With the growing wheel (tyre) width, the pressure spreads to a smaller depth, but to a greater width. Soil pressure distributions in space are graphically represented by lines connecting the points of equal pressure levels, namely isobars. The dependence of this pressure spreading in the soil on the type of tyre, its width and inflation pressure is shown in Fig. 34. where the load on all tyres is identical, amounting to 7.1 kN. The figure shows the positive influence of growing tyre width on the reduction of pressures at individual levels under the soil surface and sidewise from the symmetry plane of tyres. The figure thus demonstrates illustratively causes of the beneficial effect of using low-pressure tyres.

Plastic deformations of earth (compression) or its squeezing to sides, i.e. track (rut) formation occur due to pressures of tyres in the bearing surface area during the machine motion in less bearing and non-bearing terrain. Dynamic properties of the base (soil surface) on which the machine travels, namely soil elasticity and plasticity, influence the soil pressure value and the rut formation. The track depth directly affects the driving properties and the surface and root system disturbance. A wheel makes a shallower track at a higher speed, because the earth needs a certain time for deformation. Most of the wheel load is transmitted by compressed air in the tyre, only a smaller part is transmitted directly by the tyre carcass material. If the tyre casing material is ideally elastic, the pressure onto the base  $p_s$  would be equal to the inflation pressure  $p_p$ . In normal conditions, the specific pressure is a multiple of the inflation pressure within a range of  $1.5 - 2 p_p$ . The tyre load has an essential influence on the size of the seating surface area  $S_D$  in case of certain tyre types. The tyre volume changes very little only at loading; therefore, the specific pressure almost does not change till a certain load, it grows slightly at the wheel loading only when the tyre is overloaded. The soil disturbing by compression of large pores affects adversely the total soil structure, exchange of ions and gases and water movement both in horizontal and vertical directions. The soil deformation affects the aeration above all and thus also the roots growth and distribution. It is significant in spruce stands where the root system is placed in the horizon below 10 cm approximately and it is easy thus to damage it mechanically. Moreover, an uncontrolled soil erosion occurs on slopes, since an un-rehabilitated rut is a starter of an erosion groove. A narrow deep rut in clayey soil is considered to be more harmful than wide and shallow rut on a soil structure with a greater content of skeleton material.

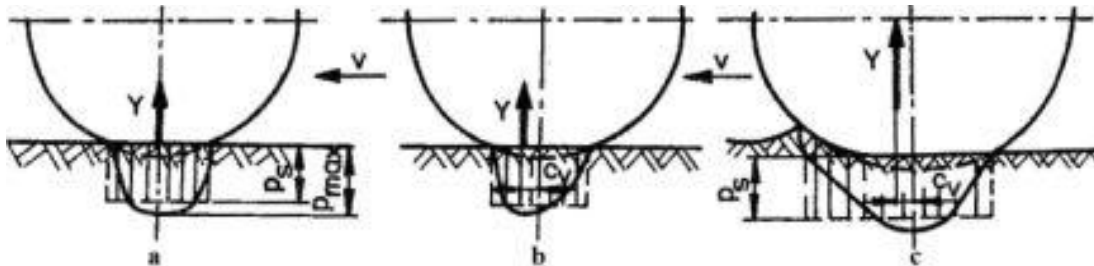


Fig. 35. Differences in the distributions of specific pressures under a wheel at rest on the hard base (a), moving wheel on the hard base (b), and drive wheel on the soft base (c)

Specific pressure source	Specific pressure	Type of soil	Soil bearing capacity
human foot	50	marsh	20
horse hoof	140	dry sand	200
standard tractor tyre	100 – 400	wet sand	400
low-pressure tractor tyre	70 – 300	gravel soil	500
caterpillar tractor	30 – 100	wet clay	100
		dry clay	400
		rocky base	2500
		ridden snow	900

Table 6. Reference values of specific pressure on the soil and bearing capacity of soils (kPa)

An ideal value of the specific pressure on the soil in the bearing surface area is 50–80 kPa, which is a value hardly attainable at present even in low-pressure tyres, since the recommended pressure of inflating low-pressure tyres is minimally 100 kPa for the sake of preventing their damage. The specific pressure of low-pressure (wide) tyres of forest machines is therefore usually 100–280 kPa so that each machine travel on the soil causes a change of soil structure even when low-pressure tyres are used. It has been verified that the highest soil compaction occurs at about the third machine travel in the same track. Moreover, the soil surface layer is crumbled by the effect of tyre lamellas at each travel, which further contributes to soil structure changes. It follows i.e. that at timber skidding, it should be decided whether more travels of a vehicle with the smaller load or less travels of a vehicle with the greater load should be selected.

Based on the existing knowledge, it is possible to make following the **conclusions for operational practice**:

- the specific pressure under a tyre of smaller dimensions shows lower dissipation to sides and reaches into smaller depths (it is assumed that smaller tyre is proportionally less loaded compared to larger one)
- if two compared tyres are of the same diameter but different in width, lower dissipation of pressures occurs under the narrower tyre but the soil is affected to a greater depth
- one and the same tyre behaves differently in different soils; the more flexible and humid soil, the lower the dissipation of specific pressure to sides and the greater the depth of pressure effects, which among other things affects the stand root systems
- large sized low-pressure tyres of at least 600 mm in width are optimal for use in the field conditions; however, reduction of negative effects on the soil by using them should not be overestimated.
- At using low-pressure tyres, specified values of inflation (up to 100 kPa) must be adhered to otherwise their positive influence decreases (it was even detected that an over-inflated low-pressure tyre may act with a greater specific pressure on the upper soil layer than a standard tyre, because its tread bulges and thus the bearing surface area is reduced)
- an effective measure is covering especially the line sections of lower bearing capacity with a layer of brush min. 40 cm in height
- a limit for acceptable depth of ruts created by travelling wheeled machines is 15 cm; however, an effort should be always made to minimize this machine travel impact on the soil
- the work of wheeled chassis should be limited on water-logged soils even with low-pressure tyres and the number of travels on the same track should be generally limited to minimize ruts.

#### 4. Basic principles of hydraulic mechanisms

It is characteristic for the means of mechanisation used in almost all areas of forest production that not only mechanical systems but also hydraulic systems are applied very frequently for the energy transfer from a combustion engine to drive working gears of machines or adapters connected to them. Principles of hydraulic systems are used in mobile machines for both driving their travel, directional steering, braking, chassis and cab stabilization as well as for driving the working systems. Hydraulic systems are typically used e.g. in drives of three-point hitches of tractors, in hydraulic cranes and grapples of truck-and-trailer units and forwarders etc. Harvesters and other logging and hauling machines display the most sophisticated use of hydraulic systems currently. It should be stressed that energy transfers using hydraulic systems are usually designed in combination with other principles, most frequently with the mechanical transmission (see also Chapter 6.2.1.).

Hydraulic systems constitute a part of the so-called fluid mechanisms which consist of hydraulic and pneumatic elements and may be also assembled as combined with other principles of energy and information transfer. Energy carriers in the fluid mechanisms are:

- gases (air, inert gases) in the pneumatic systems
- liquids (mineral, plant and synthetic oils and other liquids) in the hydraulic systems.

Methods of energy transfer in the means of mechanisation and some of their functional features:

- mechanical transmission (the oldest principle, high efficiency, technically complicated solutions, more difficult solutions of energy remote transfer, sensitivity to overloading)
- electrical transmission (useful only in certain cases, bound to the source at great power transmissions, considerable weight of electric drives)
- pneumatic transmission (*advantages*: low operating cost, safety of operation, sufficiency of medium – air – and its environmental safety, possibility to overload pneumatic machines, modular concept; *disadvantages*: higher economic requirements for energy transfer, low transmission efficiency, limited value of air compression - max. 0.7 – 0.9 MPa, large-sized and heavy equipment needed for higher power inputs, linkage to the source, influence of physical processes in the medium on operating reliability)
- hydraulic transmission (see hereinafter)
- combined transfers:

- mechanically-hydraulic and hydraulically-mechanical (the most frequent combinations at energy transfer in working systems, used in control circuits, too)
- electrically-hydraulic (used in power and control circuits)
- hydraulically-hydraulic (used in control circuits)
- pneumatically-hydraulic (used in power and control circuits)
- mechanically-pneumatic (used in power and control circuits)
- electrically -pneumatic (used in power and control circuits), etc.

#### 4.1 Advantages and disadvantages of hydraulic mechanisms

Advantages:

- not too complicated energy transfers via tubes and hoses even to relatively distant places
- achieving energy transfers and force effects using simple mechanisms
- possibility to transmit high power outputs using relatively small components at high operating pressures (to 500 bar)
- simple and continuously adjustable regulation of velocities and rotation speed
- the simplest and continuously regulated change of rotating motion to linear
- easy energy distribution
- continuous regulation of forces and torques
- easy change of motion direction
- capability to withstand overload and simple protection against overloading
- smooth running
- presence of pressure medium facilitates perfect lubrication and low wear of elements
- smaller weight and dimensions in comparison with electric drives (>15 times)  $\Rightarrow$  smaller inertial forces and smooth reversal
- using standardized elements for constructing hydraulic circuits (modular concept).

Disadvantages:

- losses due to friction are directly proportional to flow velocity, they cause e.g. decreased efficiency, heating of liquid, noisiness
- viscosity changes of medium due to changes of its temperature  $\Rightarrow$  necessity to newly set the control elements to retain parameters of the circuit
- design complexity of energy converters – generators and engines, requirements on the accuracy of element manufacturing and their tightness
- the system becomes flexible with the increasing circuit length and heads towards oscillating
- high requirements on working fluid
- presence of air in the fluid  $\Rightarrow$  uneven and jerking working motions
- working medium – hydraulic oil is a combustible matter as a rule
- contamination of the environment threatens if the medium leaks.

#### 4.2 Theoretical basics of hydromechanics of hydraulic circuits

Hydraulic systems or drives are classified into hydrostatic ones that use the pressure energy of fluid and hydrodynamic ones that use the kinetic energy of flowing liquid. Thus, the discipline of “hydrostatics” deals with forces in the still liquid and the discipline of “hydrodynamics” deals with forces in the moving liquid. The theory of hydromechanics of hydraulic circuits is relatively extensive; only some parts necessary for understanding the action of hydraulic circuits are included in this text.

The energy (power output) transfer in the means of mechanisation is displayed in Fig. 36. A mechanical drive (usually combustion engine in mobile machines) is a source of torque  $M_1$  on the shaft with the rotation speed  $n_1$ . The originating power input  $P_1$  enters the hydrogenerator, in which it is changed into hydrogenerator power output  $P_{hydrs}$  given by liquid flow  $Q$  and pressure  $\Delta p$ . The  $P_{hydr}$  power proceeds through the control system further to the hydraulic consumer, which is a rotation or a linear hydraulic motor. The hydraulic motor changes the power input  $P_{hydr}$  to the mechanical power output  $P_2$ . In the rotation hydraulic motor,  $P_2$  is given by torque  $M_2$  on the hydraulic motor shaft with the rotation speed  $n_2$ . In the linear hydraulic motor (hydraulic cylinder),  $P_2$  is given by force on the piston rod  $F$  and velocity of piston rod motion  $v$ . Losses occur in the individual transfer nodes, therefore  $P_2 < P_1$ .

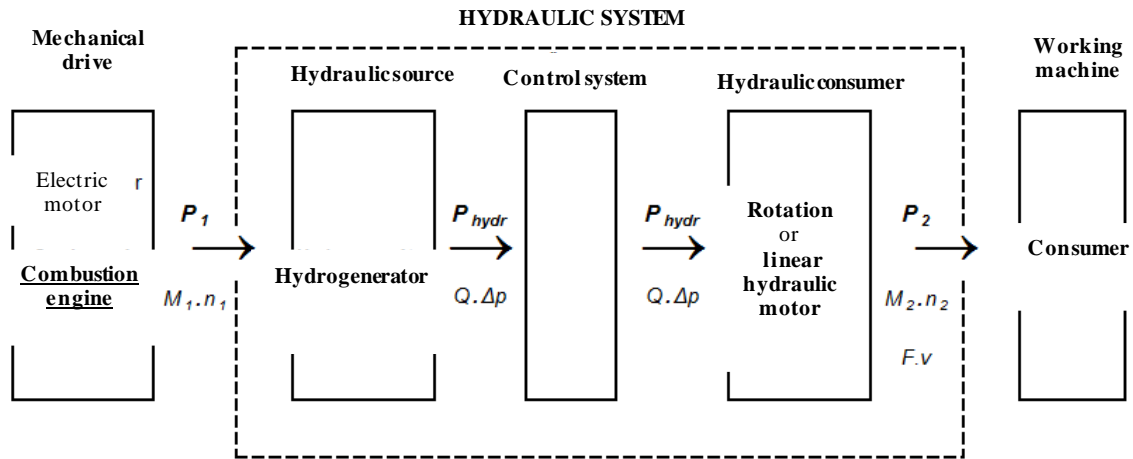


Fig. 36. Block diagram of energy transfer in the hydraulic system (power output flow)

### 4.3 Hydrostatic systems

This group of hydraulic circuits uses the pressure energy of liquid supplied by the hydrogenerator (pump), carried by pipe and hose distribution systems to the place of consumption (hydraulic motor) and converted to the mechanical energy in it again. **Pascal's law** is a basic physical law on which the theory of hydrostatics is built. The pressure energy of liquid is brought under pistons of linear hydraulic motors (hydraulic cylinders) or rotation hydraulic motors through control elements where the force and linear or rotating motion arise.

#### Hydrostatic elements and circuits

**Hydrogenerators** (pumps) – transfer the mechanical energy supplied by motor (combustion engine, electric motor) or in exceptional cases by human force into the pressure energy of liquid. As to their design, they are distinguished into gear, piston, and lamellar types. Their basic parameters are input rotation speed and the liquid flow provided at pressure. The liquid flow provided by the hydrogenerator can be regulated by changing the driving engine rotation speed or by regulating pumping parameters of the pump itself, e.g. by setting the foldable plate determining the lift of pistons or by positioning the lamellar rotor. The flow rate through the hydrogenerator may range from several tens to hundreds of litres per minute depending on the type.

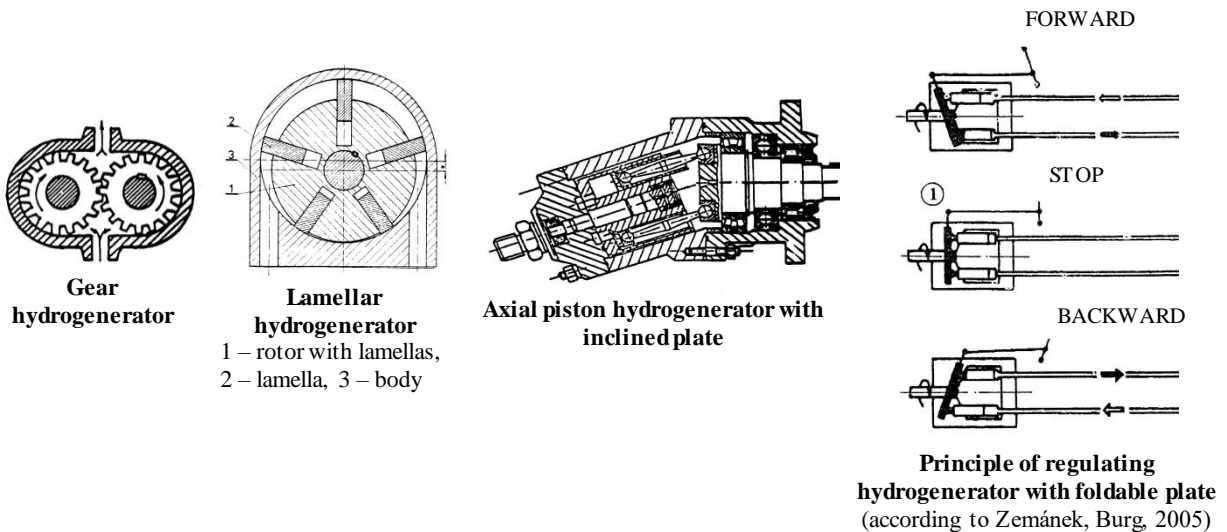
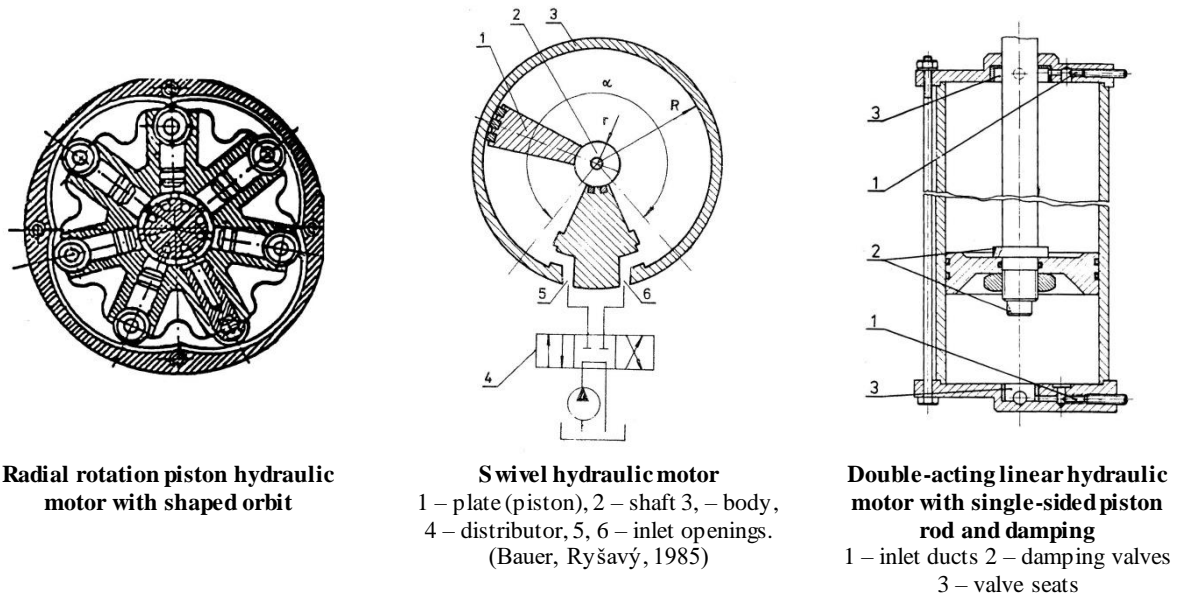
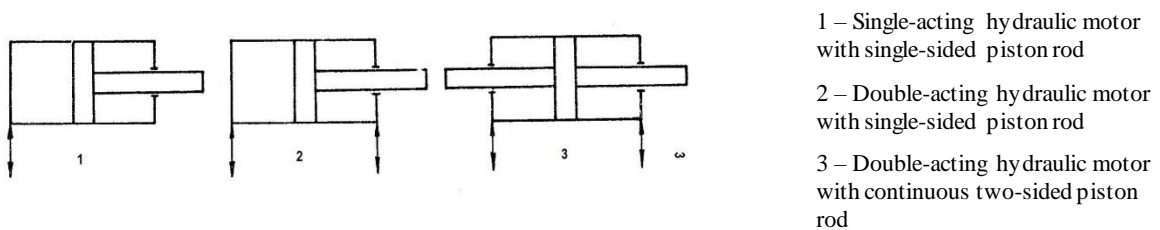


Fig. 37. Examples of hydrogenerators

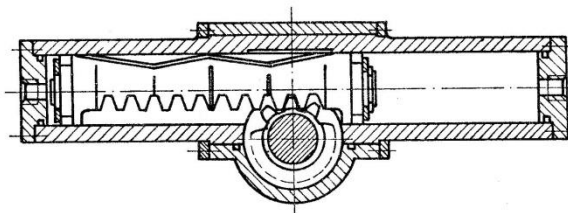


**Fig. 38. Examples of hydraulic motors**

**Hydraulic motors** are hydrostatic elements which transfer the pressure energy of the fluid to the mechanical energy again for pushing out piston rod at a certain force and speed or turning shaft at a certain torque and rotations. Hydraulic motors are manufactured as **rotational, linear, and rocking hydraulic motors**. Rotation hydraulic motors are manufactured as regulating and non-regulating and are similar to hydrogenerators as much as their design is concerned. The regulation consists in changing the stroke volume of pistons by adjusting the foldable plate. This method of rotational speed control of hydraulic motor is more appropriate, because it does not result in high hydraulic losses due to throttling the flow of fluid into the hydraulic motor (see below). Linear hydraulic motors are produced in many versions and sizes, in standardized series as a rule.



**Fig. 39. Principles of linear hydraulic motors (hydraulic cylinders)**



**Fig. 40. Hydraulic motor with toothed rack and pinion** (the principle is used e.g. for slewing mechanisms of hydraulic cranes) (Bauer, Ryšavý, 1985)

**Hydraulic distributors** are hydraulic elements ensuring the control of hydraulic circuits, i.e. they serve the purpose of damming the fluid flow in branches of hydraulic circuit. They facilitate opening, closing or limiting the fluid flow, direction change, etc. Thus, they allow to start, stop, slow down or reverse the run of mechanisms. Distributors are of very diverse designs that correspond to their tasks. The distributors consist of sections which differ by their properties and by the number of so-called positions, i.e. variants of interconnecting the ducts (e.g. in the basic position the fluid flow through the section is open, closed, fluid returns back to the tank, etc.). The distributors can be controlled mechanically

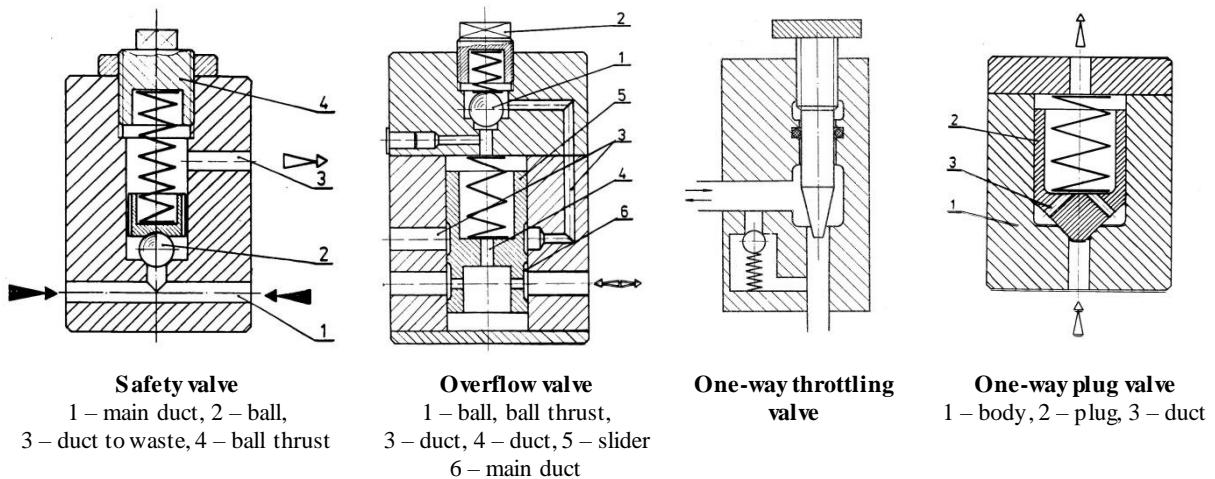
with direct manual setting, electromagnetically (12 or 24 V usually) or hydraulically, when the distributor of a so-called power circuit e.g. with a pressure of 500 bar is controlled by an auxiliary circuit with a pressure of e.g. 60 bar.



1 – two-position, 2 – three-position, 3 – four-position  
**Fig. 41. Examples of four-way distributor schematics**

**Elements for pressure control** secure, maintain or reduce the working pressure in a circuit. **Safety valves** are necessary parts of each hydraulic circuit or individual element, since they prevent pressure over-loading that might lead to damages of hydraulic elements, to the rupture of hoses in particular. **Overflow valves** maintain the working pressure at a certain level and drain an excessive fluid amount to waste. **Reduction valves** provide for decreasing the working pressure within a certain range.

**Throttling valves** serve the purpose of continuous regulation of fluid flow rate and thus modify the motion speed of the hydraulic motor. Note: On these valves, the highest hydraulic losses occur due to flow profile reduction and therefore they should be used prudently.



**Fig. 42. Valves for pressure and flow control**

**One-way valves** provide for the fluid flowing in one direction only, with the flow being blocked in the opposite direction. These valves often incorporate also the function of flow throttling.

Hydraulic lock closes fluid inlets into the linear hydraulic motor in case of pressure drop in the circuit. This ensures the position e.g. of hydraulic crane jib or truck-and-trailer vehicle upon a system failure. The hydraulic lock opens only after the fluid pressure is brought to the hydraulic motor.

**Hydraulic accumulator** is an element serving the purpose of retaining a small amount of compressed fluid. As a rule, it is designed as a steel tank divided into two parts by a membrane; it may also be of bag type, etc. In the part above the membrane, the inert gas (e.g. nitrogen) is pressurised, the fluid is pushed into the part below the membrane, the membrane deflects, and the pressure energy is accumulated thereby. Hydraulic accumulators are used for example in those phases of activity when the available pressure fluid is needed, but not supplied by the generator yet. A typical forest machine using this design in practice is the branch trimming unit in which pressure fluid from the accumulator is used to clamp delimiting knives after the tree is put into the machine.

**Hydraulic cleaners (filters)** are necessary parts of hydraulic circuits because they remove metal particles and other impurities from the hydraulic fluid that would increase the wear of moving parts of the system and become otherwise the source of its failures.

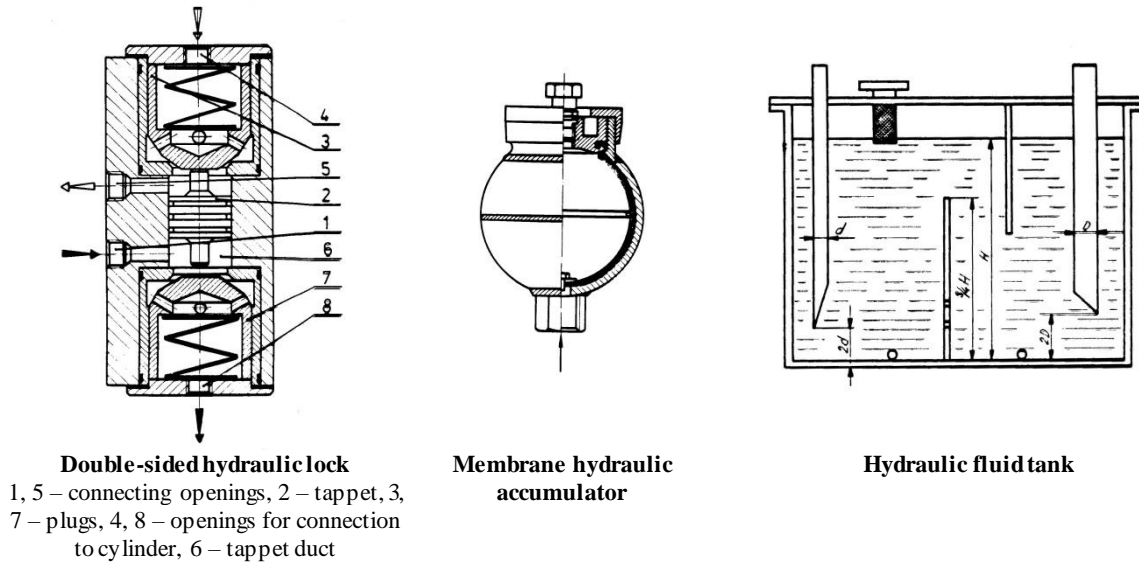


Fig. 43. Other hydraulic elements

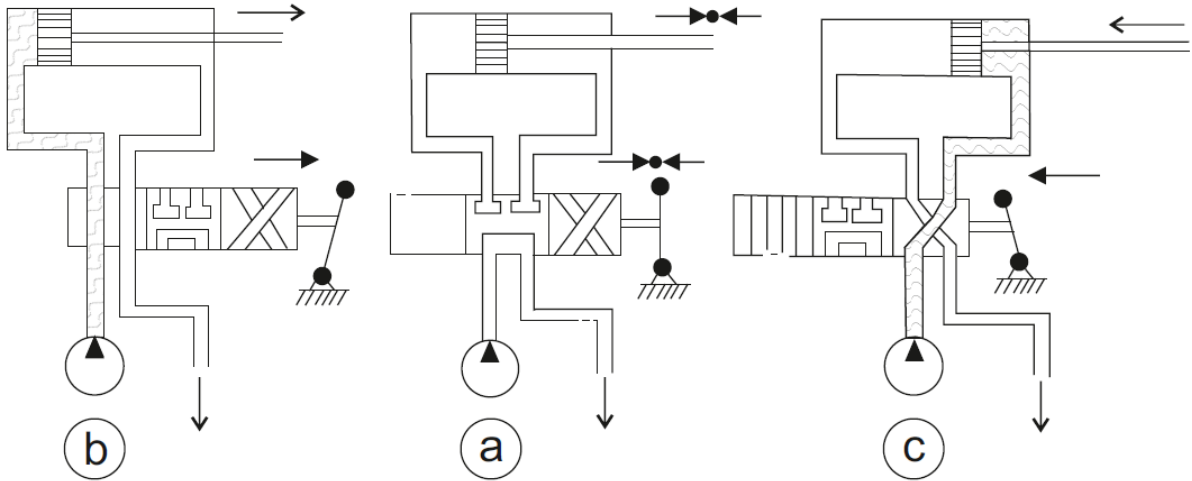
**Hydraulic fluid lines** are steel tubes and pressure hoses that are connected by screw joints with each other as well as with other hydrostatic elements. Lines on return branches to the tank use to have a larger inside diameter than the pressure lines in order to reduce hydraulic losses. The lines must be robust enough to withstand the foreseen working pressure even at its peaks that may reach even more than a triple of the rated pressure. Contrary to older machines with working pressures around 120 bar, many of today's machines have working pressures as high as around 500 bar. The hoses must not be stretched mechanically and must have smooth bends with large radii.

The hydraulic fluid **tank** is an important part because it ensures not only a sufficient fluid reserve, e.g. even if the machine is inclined, but serves the purpose of its calming down after passing the system (foaming) and cooling. Therefore, it must be properly dimensioned.

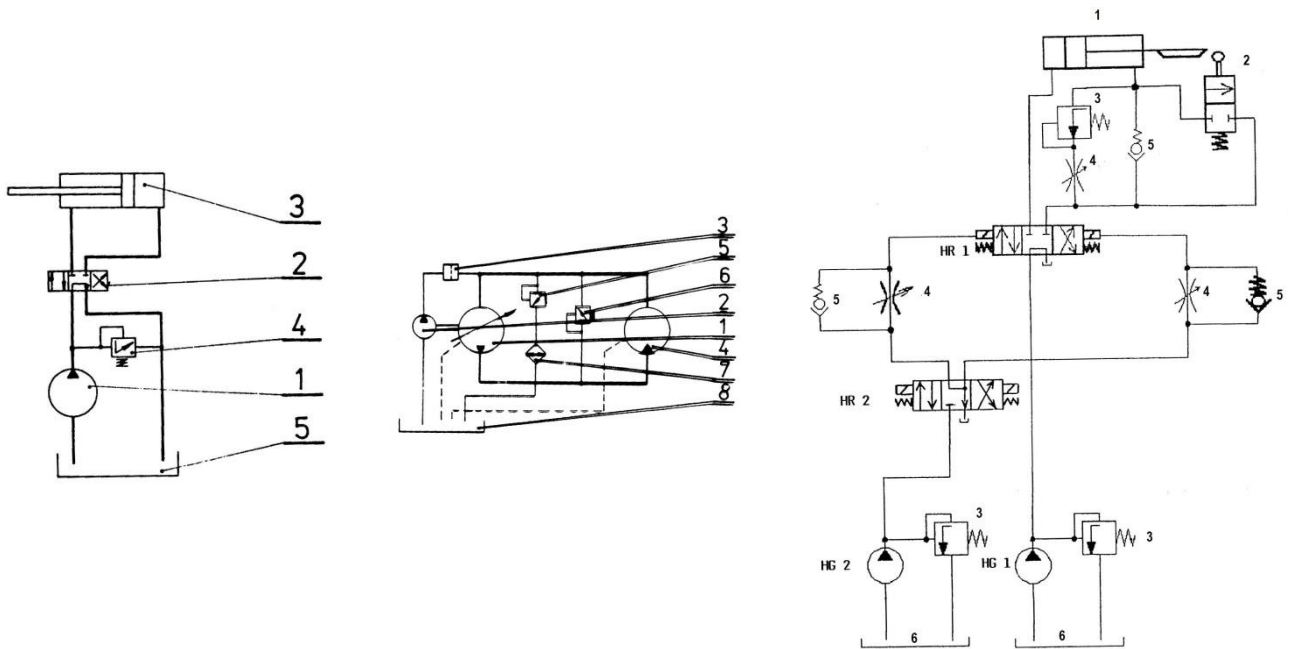
**Coolers** with the forced air flow serve the purpose of cooling the hydraulic fluid after it passes through the system. It is necessary especially for heavy duty hydraulic mechanisms. A fan driven by the electric motor or hydraulic motor provides the cooling air flow.

Hydraulic elements are arranged into hydraulic circuits. A **hydraulic circuit** consists always of several elements that are interconnected by hoses or tubes. Hoses are used for movable connection of machine parts. The simplest circuit consists e.g. of hydrogenerator, linear hydraulic motor, distributor, and tube connection. We distinguish open circuits where entire fluid returns to the tank after having passed through the circuit (most frequent) and closed (where most fluid passes only between the hydrogenerator and the hydraulic motor, and the tank serves to store leakage fluid and to compensate differences in fluid volume caused by its heat expansion or leakage – used for example in power-assisted steering). Hydraulic circuits are visualised by means of technical diagrams, in which agreed signs are used for elements and their interconnection. For example, after a hydraulic circuit diagram is examined in order to identify the cause of hydraulic system failure, it is relatively easy to understand the functions of hydraulic circuits and their parts and to find and repair the failure cause based thereon. The operator of machines with hydraulic drives should have a basic capability at least to read the diagrams of hydraulic systems. It is recommended for the sake of easier orientation in hydraulic diagrams to start their “reading” from the “end” preferably, i.e. to find the respective hydraulic motor and proceed from it through distribution lines and hydraulic elements back to the hydrogenerator or tank.





a – initial (bypass) position, oil from hydrogenerator returns to the tank, hydraulic motor is locked;  
 b – fluid flows below the piston, piston rod is pushed out; c – fluid streams above the piston, piston rod is pushed in  
**Fig. 44. Control of fluid flow through the four-way three-position slider distributor**

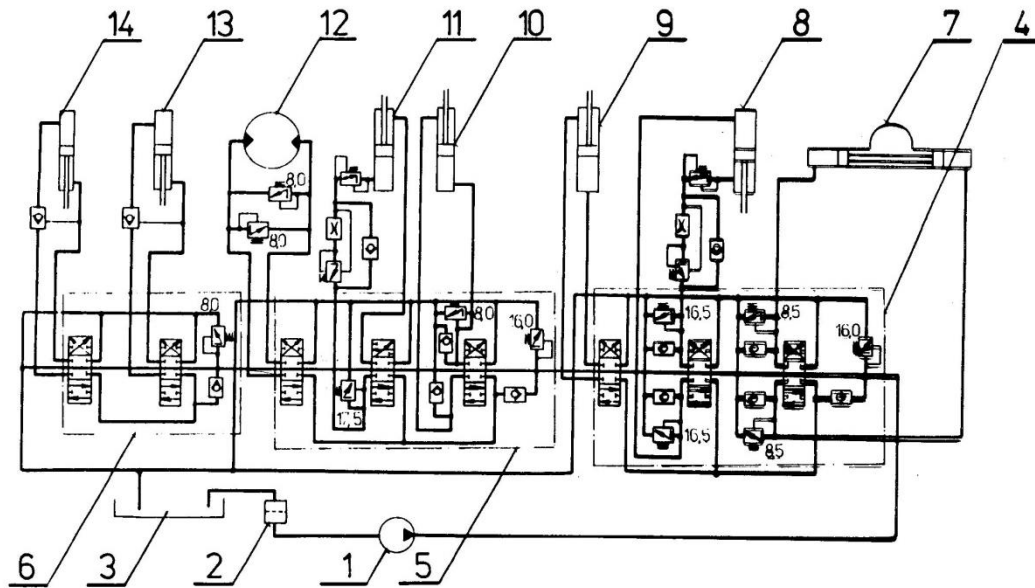


**Open hydraulic circuit** double-acting linear hydraulic motor (3), four-way three position distributor with bypass in basic position (2), pressure valve (4), one-way non-regulated rotation hydrogenerator (1), and tank (5)

**Closed hydraulic circuit** control one-way hydrogenerator (1), auxiliary hydrogenerator (2), filters (3, 7), 4 – non-regulated one-way rotation hydraulic motor, pressure valves (5, 6), tank (8)

**Doubled open hydraulic circuit with working and control parts** linear double-acting hydraulic motor (1) with cam controlling valve stops (2), pressure valves (3), throttling valves (4), one-way valves (5), tank (6), hydrogenerator 1, HR 1 – working high pressure circuit (HR 1 controlled by fluid from HR 2), HG 2, HR 2 – control low-pressure circuit

**Fig. 45. Examples of hydraulic circuits**



Non-regulating one-way hydrogenerator (1), filter (2), tank (3), control sector of main arm (4), control sector of telescope, rotation and movement of grapple jaws (5), control sector of supports (6), linear hydraulic motor with gear rack and pinion for hydraulic crane rotation (7), linear hydraulic motor of middle part of hydraulic crane arm (8), linear hydraulic motor of basic part of hydraulic crane arm (9), hydraulic motor of telescope (10), hydraulic motor of grapple jaws (11), two-way rotation hydraulic motor of grapple rotator (12), linear double-acting hydraulic motors of supports (13, 14)

**Fig. 46. Hydraulic circuit of the control of hydraulic crane with grapple**

#### 4.4 Hydrodynamic systems

These systems are based on the principle of gaining energy from the flowing liquid. Fast flowing liquid hits the wheel blades of turbine, by which the turbine starts to turn and hence is a source of mechanical power. These mechanisms are used for the drives of chassis in mobile machines (tractors, dozers, loaders). Their design is relatively complicated and demanding as regards manufacturing, which means relatively costly, too. They can be found mainly as hydrodynamic couplings and fluid converters.

**Theoretical bases** of hydrodynamic systems are contained in three equations: Equation of kinetic energy, Equation of continuity and Bernoulli's equation.

##### Hydrodynamic elements

**Hydrodynamic coupling** is a hydraulic element consisting of a pump and turbine. The pump is driven by the combustion engine with  $M_1$  torque and  $n_1$  rotation speed. Radial blades of the pump push the liquid to similar turbine blades at a great speed thus transferring the  $M_2$  torque onto it.

It means that a hydraulic coupling changes neither the torque nor the rotation speed. In fact, however, the rotation speed of the turbine wheel is by 2 – 4 % lower at a normal load than the rotation speed of the pump wheel. This helps to achieve a soft machine start and engagement. These couplings are suitable wherever frequent machine stops and smooth starts are necessary.

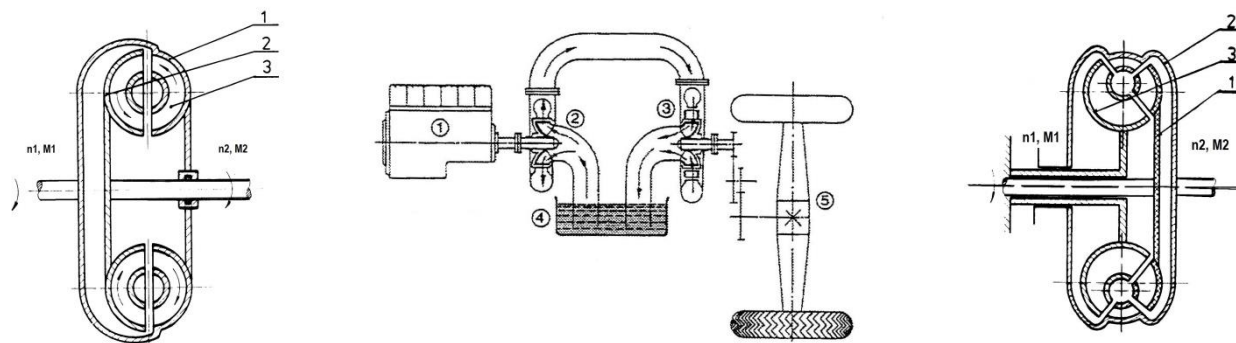
**Hydrodynamic converter** may be characterised as a hydraulic coupling with the continuously changeable speed ratio and with properties of hydraulic coupling. A hydrodynamic converter consists of three basic parts:

- pump wheel (1)
- turbine wheel (2)
- guide wheel with fixed blades (3).

The liquid flows from the pump wheel onto the turbine wheel and returns from it through fixed guide blades back to the pump wheel in the hydrodynamic converter. The parameters  $M_1 n_1$  enter the converter from the combustion engine and the parameters  $M_2 n_2$  leave the converter. When the flowing liquid passes the fixed blades L, a reaction torque  $M_r$  arises, which alters by the difference between rotation speeds of the pump and turbine wheels. When the turbine wheel T begins to rotate (the machine starts

functioning), the stream of liquid from the pump and turbine wheels thrusts perpendicularly on the blades of guide wheel L and thus creates a high reaction torque  $M_r$ .

It follows from the above that the greatest machine engagement occurs in the phase of its start of functioning (when  $M_2 = M_l + M_r$ ). Both torques become equal ( $M_2 = M_l$ ) in the coupling mode after the start of functioning. The fact is advantageous even if compared with the classic mechanical graded gear whose efficiency is very good ( $\eta_m \approx 0.93$ ) but its combustion engine cannot operate at full at the machine start, which is on the contrary possible at the start of machine with the hydrodynamic energy transfer. The continuously changeable speed ratio of these mechanisms is usually 1: 2 up to 1: 5.



**Hydrodynamic coupling**  
1 – pump, 2 – turbine,  
3 – turbine blades

**Principle of transferring hydrodynamic forces to chassis axle**  
1 – combustion engine, 2 – centrifugal pump, 3 – turbine, 4 –  
oil tank 5 – driving axle with gears (Zemánek, Burg, 2005)

**Hydrodynamic converter**  
1 – pump, 2 – turbine,  
3 – guide wheel

**Fig. 47. Hydrodynamic elements and their functions**

#### 4.5 Hydraulic liquids

The purpose of hydraulic liquids is to ensure energy transfer with as low as possible losses caused by friction and wear. Hydraulic liquids fulfil also other tasks: lubrication of moving elements, cooling of elements, protection against corrosion, etc.

Hydraulic liquids generally may consist of water, water-based mixture (glycols) and oils (mineral, plant, and synthetic ones). Advantages and disadvantages of individual types of hydraulic fluids:

- water (cheap, harmless, does not protect against corrosion, low boiling point, does not lubricate)
- glycols (similar to water, suitable for large volume systems, better protection against corrosion)
- plant oils (usually refined rapeseed oils, environmentally harmless, worse service properties, poor thermo-oxidative stability - lower service life, necessity to use additives)
- synthetic oils (excellent service as well as environmental properties, higher price).

Requirements for a more efficient energy utilization, reducing friction and increasing mechanical efficiency result in design changes of hydraulic systems and in increased demands on hydraulic fluids. Minimum plays of hydraulic elements require that the oil is well filterable by very fine filters even at the presence of water. An acceptable viscosity of hydraulic fluids must be ensured within the range of working temperatures. The viscosity decreases with the increasing temperature and vice versa. The so-called kinematic viscosity of fluid is as a rule specified for a temperature of 50 °C. Fluids are classified in SAE viscosity classes according to their kinematic viscosity. The acceptable viscosity of hydraulic fluids must be ensured in circuits namely during the winter period (e.g. by electrical heating or machine parking in a heated space). If this cannot be ensured, it should be emphasized that the hydraulic system of a cool machine cannot be loaded with full power immediately after its start – the unloaded machine must be put into motion carefully at first and then it is necessary to wait for several minutes until the fluid warms up in the circuits. The viscosity of cool fluid is too high, which might lead to serious damage of hydraulic elements, if the above-mentioned principles are not adhered to.

The quality of hydraulic oil depends on the quality of basic oil and on the combination of additives. Hydraulic oils must fulfil the specifications of ISO 11158 and ISO 6743-4: HV. Biologically degradable hydraulic oils must fulfil the specifications of ISO 15380 and ISO 6743-4: HEES. Mixing different oil types may cause downgrading of their properties and is therefore unwanted.

Pursuant to Section 32 of the Act on Forests No. 289/1995 Coll., the forest owner is obliged to protect the forest against pollutants escaping or arising during his economic activities. In the forest, he is obliged to use only biodegradable oils for lubricating the chains of motor saws and biodegradable hydraulic liquids.

For the above reasons, synthetic oil based on hydraulic fluids are used in harvesters and forwarders and also in all other machines with hydraulic drives employed in the forest environment. They have excellent utility properties and are biodegradable at the same time. Biodegradable oils must be protected against overheating (70 °C are optimal). Nevertheless, the life of biodegradable oils, being 800 to 2 000 hours approximately, is lower than the life of mineral oils. It is therefore necessary to respect the instructions of machine manufacturers concerning intervals of hydraulic filling replacement. Handling the used oils is governed by Act No. 167/1998 Sb., on waste.

#### 4.6 Operation and maintenance of hydraulic circuits

Basic principles of operation and maintenance of hydraulic circuits are specified in operating instructions for the respective machine that must be respected. It is not allowed for example:

- to set the regulating elements to higher pressures than accepted by the manufacturer
- to work with the lack or excess of fluid in the circuit
- to use the hydraulic fluid after its service life has expired
- to mix various fluids
- to neglect the cleaning of filters at specified intervals
- to carry out maintenance and repairs with the machine in operation; at disassembling hydraulic elements of the system, mechanical parts must be secured against unwanted motion (e.g. uncontrolled drop of hydraulic crane arm), etc.

### 5. Mechanized ground-based timber skidding

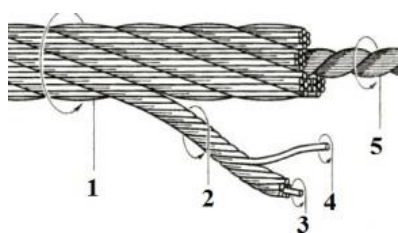
An optimum solution of the technological phase of timber skidding, technological continuity of machines must be looked at in the whole complex of operations and their arrangement in the production procedure based on the logging method.

#### 5.1 Cables, chains and chokers in forestry

Cables are made of various materials – steel, man-made fibres, hemp etc. Cables used in forestry are mostly made of steel. **Steel cables** are very fragmented products manufactured from a given number of bare or galvanized steel wires twisted into bundles of regular diameter – strands which are spliced into cables.

##### Basic utility properties of cables

- cables can be strained only by pulling and bending
- compared with cables made of other materials, steel cables have a high load capacity at a small diameter
- flexibility and ability of being wound up onto drums and going through pulleys
- relatively low weight
- good wear resistance
- capacity for being lengthened, stranded, ended, etc.



- 1 cable proper
- 2 strand (6 strands in this case)
- 3 middle wire of strand = strand core
- 4 individual wires spliced in layers into strands
- 5 core = cable insert

Fig. 49. Cable – Basic parts

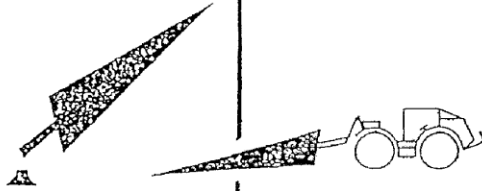
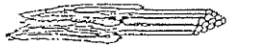
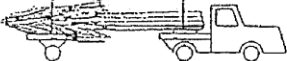




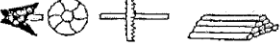

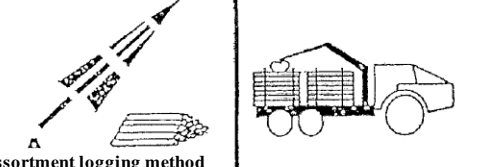

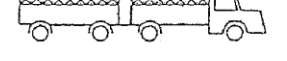
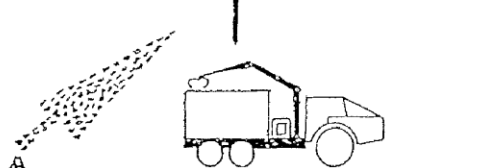

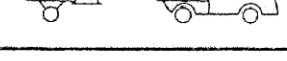
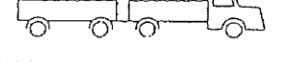




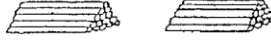


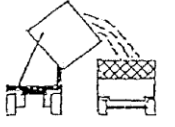

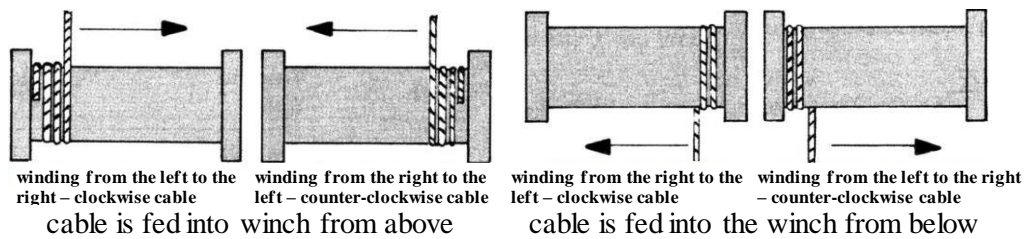
Working at stump	Skidding line (lane)	Deck	Timber hauling
			
<p>Whole-tree logging method</p>			
			
			
<p>Tree-length logging method - whole stems</p>			
			
			
<p>Tree-length logging method - cross-cut stems</p>			
<p>Assortment logging method (cut-to-length)</p>			
<p>Chipping of whole trees</p>			

Fig. 48. Examples of solutions and continuity of alternative technological phases in the process of timber logging and hauling

## Basic characteristics of cables

- **material**
  - steel, nominal strength 1270, 1570 and 1770 MPa, (but also 1960 and 2160 MPa for skylines and guylines of cable transport installations), steel cables are made from special cold profiled wires of usually circular cross-section, wires are either bare or galvanized
  - hemp (natural materials)
  - man-made fibres.
- **purpose and use** (skylines, skidding lines, guylines, grass lines, auxiliary cables, steering lines, etc.)
- **construction** (winding mode and arrangement of wires and strands, number of strands, nominal cable diameter, nominal diameter of wires, etc.)
- **surface finish** (bare, galvanized, semi-closed, closed, rolled)
- **rolled strands and rolled cables** cables are compacted by rolling individual strands and whole cables, and rolled cables of smaller diameters are stronger than the common ones. Smooth rolled surface increases the service life of cables through lower abrasion and lower friction on the soil makes the load dragging easier.
- **internal tension modification** (non-numbered, numbered)
- **strength characteristics** (nominal strength of cable wire material in MPa, admissible cable load in kN)
- **number of strands** (most often 6-strand cables)
  - single strand cables
  - multiple strand cables
  - multiple cables (coiling of several cables)
- **design** (most frequently normal design)
  - twisted cables – rigid twisting cable, core is missing, they are not used in forest practice as they require large pulleys and cable drums, cannot be spliced – connection is possible only by pressed couplings
  - normal design – all wires of the same cross-section
  - Seal design – each layer includes wires of the same diameter, diameters in different layers differ (outer layer is formed by wires of larger diameter). Each layer has the identical number of wires and hence the same pitch (winding height); thus, wires of the outer layer properly fall into troughs of the inner layer. Since the contact area between the wires of both layers is larger than in cables of normal design, specific pressure is lower and cable durability is higher. As compared with the Warrington cables, its wear resistance is higher.
  - Warrington design – enlarged contact area between the wires of neighbouring layers, small- and large diameter wires alternate in the second layer. Flexibility better than Seal.
  - Warrington-Seal design – is a combination of both designs. Strands have more layers of wires; outer wires are of larger diameter. Very good flexibility and abrasion resistance.
  - Filler design – the space between large diameter wires of inner layers is filled with low-diameter wires.
- **cable core (insert)** improves cable flexibility and lubrication. It can be made of **textile** (hemp, man-made fibres) which is lighter than steel and thus the cables with textile cores are used as binding cables, guy lines and suspension cables; **compact plastic core** is made of fibres enclosed in plastic and its ductility is lower than that of textile core; cables with this core are useful as drag lines of long-distance cable transport installations; **steel core** is a single steel strand or cable, cables with a steel core are resistant to crushing and their strength is by 15-20 % higher than that of cables with a textile core, they are used at places with the requirement of high strength at a limited capacity of drums – i.e. as towing cables of tractor winches and haul and haul-back cables of cable transport installations; **steel core with plastic** is a steel core enclosed in polypropylene cover, by which the spatial placement of the core and outer strands is fixed. In cable samples, core is marked in capital letters: FC textile insert (NF natural fibre, SF synthetic fibre), SC steel core (W middle wire, WS strand, WR cable).
- **internal stress in cables** results in their twisting. Cables in which the internal stress was eliminated (**numbered cables**) do not tend to twist when uncoiled. Cable numbing can be ordered from the manufacturer or achieved by passing the cable through a system of pulleys for several times.

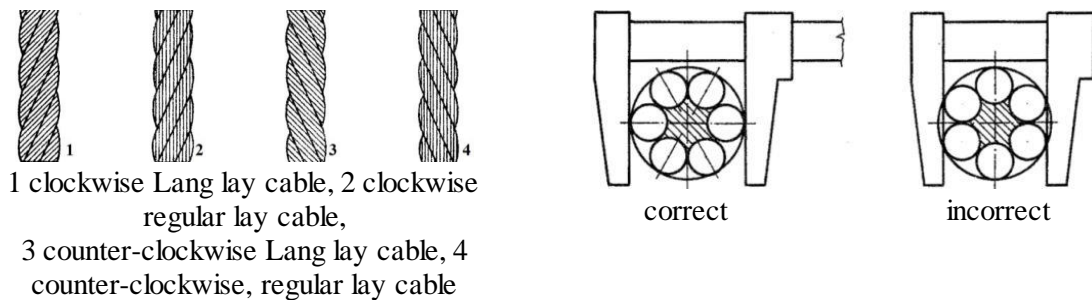
- **factor of cable filling out** is a ratio between the load-bearing cross-section of the cable and a circular area related to the cable diameter; its range is 0.5-0.8.
  - **openness of cables**
    - open cables – made only from wires of circular cross-section (most common in forestry)
    - semi-locked cables
    - locked cables
- Semi-locked and locked cables have the outer layer formed by alternating wires of circular cross-section and profile wires, which slot together very well and prevent water getting into the cable. They are used as guylines or skylines in cable cranes and cable transport installations.
- **direction of cable winding** – clockwise and counter-clockwise cables. Only cables with the identical direction of winding can be connected. If cables with different winding directions are connected, the shorter or thinner cable untangles due to pull. Selection of the direction of cable winding depends on the design of winch drum – feeding of the cable from above or from below, place of cable attachment in the drum – right or left, and the sense of cable winding onto the drum – from the left to the right or from the right to the left.



**Fig. 50. Cable winding direction according to the winch design**

- **cable winding, Lang lay cables** – direction of winding wires and strands in the cable is identical; cables are more flexible, more resistant to wear, form loops, and must be only under low permanent tension not to wind off, **regular lay cables** – direction of winding wires in strands and strands in the cable is opposite (cables are more rigid, easy to wind, less untangled), **parallel cables** from wires of different diameters (Seal), wires do not cross, contact area is large, **cross-lay cables** have wires in the strand wound in the opposite direction to the strand – they are crossed, thus having higher resistance to twisting but lower service life. Only cables with the same length of strand winding in the cable can be spliced.
- **differentiation of cables according to their use**
  - moving cables (pull cables of elevators, cableways, winches) must be flexible
  - stationary cables (guy lines, carrying cables of cable cranes) can have lower flexibility.

**Cable diameter** is measured by a calliper with wide jaws at two cable points distant 1 m from each other, in two mutually perpendicular planes. Cable diameter is a mean value from these 4 measurements. Permissible tolerance of the diameter of new cable that has not been yet extended by operation is only in plus values, in cables with a diameter over 8 mm from +4 to +1 %.

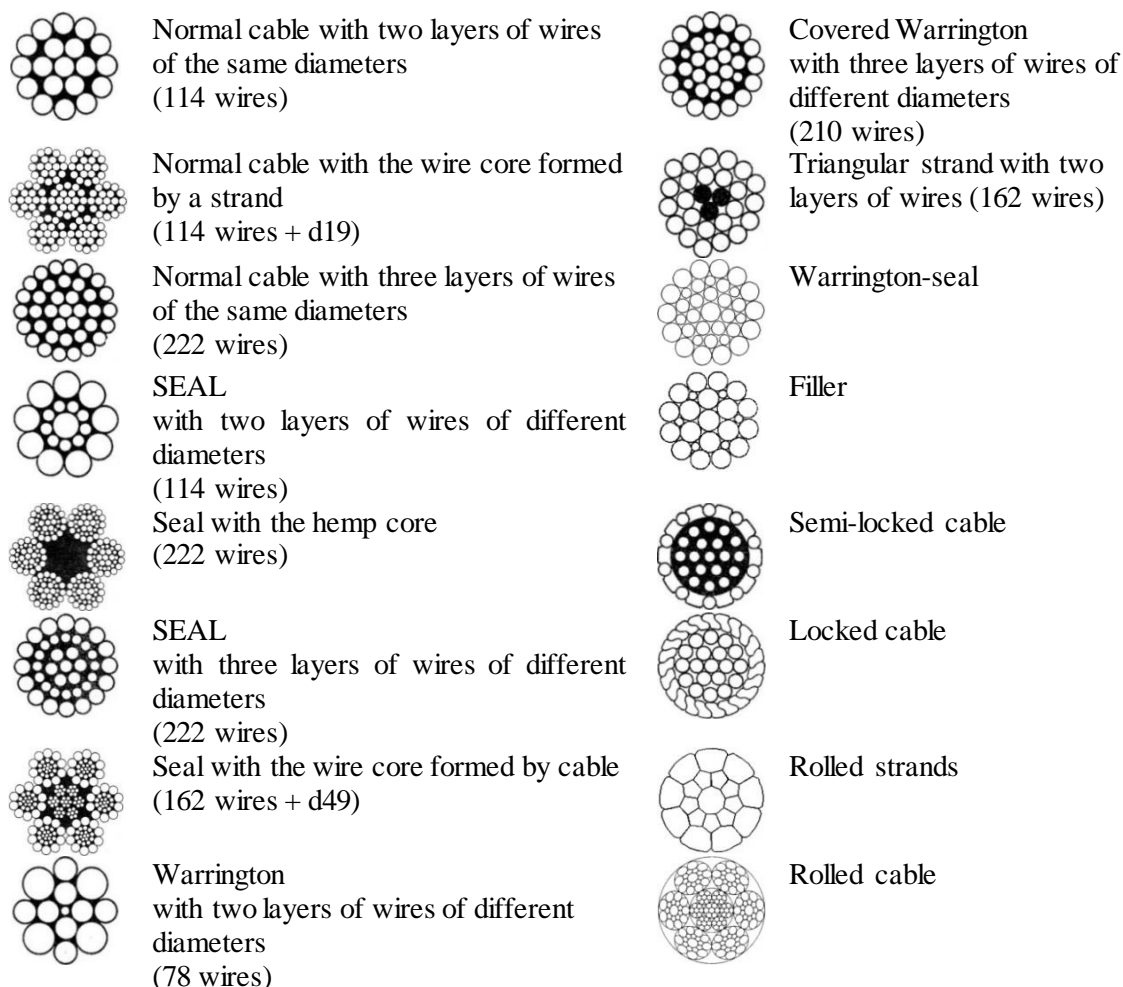


**Fig. 51. Cable winding**

**Fig. 52. Measurement of nominal cable diameter**

**Winch drum capacity** can be a limiting factor in skidding timber over large distances (on soils with poor bearing capacity, in natural regeneration, from ravines, across watercourse etc.), and a limiting

factor in adapting tractor winch to a short cable system. In cable transport installations, more expensive cables of smaller diameters are generally preferred, with a maintained load capacity though.



**Fig. 53. Examples of cable design**

**Numbering** (formula) of cable design: digit before parentheses = number of strands. In parentheses, there are number of wires in individual layers, “v” letter behind parentheses = textile core (wire core - “d” letter with the number of wires in the core, e.g. +d19).

$$6 (1+9+9) + v$$

$$6 (1+9+9) + d14$$

**Design parameters of steel cables** are important for users of the cable, who define basic utility properties there from:

- cable formula
- nominal weight of cable  $m$  [ $\text{kg}\cdot\text{m}^{-1}$ ] – weight of 1 m of cable
- nominal strength of wires  $\sigma_i$  [MPa] – the least guaranteed tensile strength of wires
- nominal cable diameter  $D$  [m] – diameter of circle circumscribed to cable
- load-bearing cable cross-section  $S$  [ $\text{m}^2$ ] – sum of the cross-sections of individual wires
- nominal load-bearing capacity of cable  $F_{max}$  [N] – load of cable on the limit of its strength, product of nominal strength of wires and load-bearing cross-section of cable
- permissible cable load  $F_{dov}$  [N] – force that can safely load the cable depends on the measure of safety expressed by the safety coefficient  $k$  (*cables of tractor winches 2–3, forest cableways 3–5*)
- requested cable properties (in the order) are specified by the number of ČSN standard with additional digits for material and surface finish, cable diameter and length; common values of nominal cable diameters in tractor winches range from 10–14 mm.



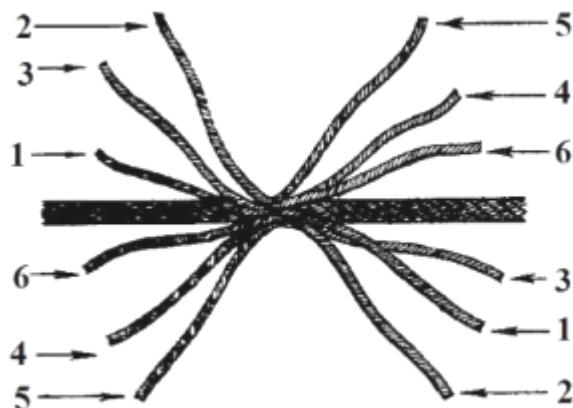
Cable type	Technical standard	Number of wires (usual)	Cable design (formula)
normal six strands	ČSN 02 4322	114	$6(1+6+12) + v$
normal six strands	ČSN 02 4324	222	$6(1+6+12+18) + v$
Seal six strands	ČSN 02 4340	114	$6(1+9+9) + v$
Seal six strands	ČSN 02 4342	162	$6(1+6+10+10) + v$
Seal six strands	ČSN 02 4344	222	$6(1+6+15+15) + v$
Seal six strands	ČSN 02 4346	330	$6(1+6+12+18+18) + v$
Warrington six strands	ČSN 02 4348	210	$6(1+6+ (6+6) +16) + v$

Tab. 7. Commonly used cables

Cable diameter (mm)	Weight of 1 m of cable (kg)	Load capacity of cable (kN) at nominal strength (MPa)	
		1570	1770
8	0.25	39.6	44.6
10	0.37	63.5	71.6
12	0.54	87.0	98.1
14	0.73	124.5	140.3
18	1.16	197.0	222.1

Tab. 8. Example of diameters, weights and load capacities of Seal cables

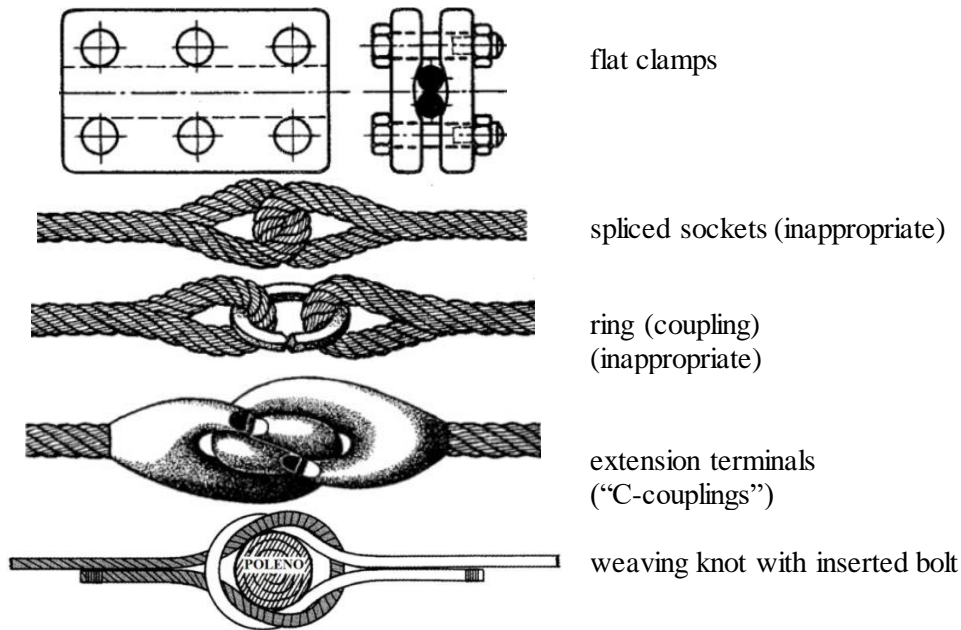
**Possibilities of connecting cables** are very useful since an optimum cable length can be chosen as needed (permanently or temporarily), or if a cable is broken or its excessively worn section is cut off, the remaining cable parts can be connected again. Only cables with an identical winding direction can be connected! If cables with a non-identical direction of winding are connected, the shorter or thinner cable untangles under tensile stress. Connection only by spliced loops or rings is not appropriate because they are mutually “cut-off” by the moving cable. A weaving knot is favoured in practice to connect two cables; a bolt is inserted into the knot so that the cables are bent over a diameter as large as possible. Only cables with the same length of strand winding can be spliced.



Cables can be connected either by **short** splicing (similar to ending, when the cable diameter in the connecting point increases, length of splicing min.  $40d$ , i.e. each strand has to be threaded at least four

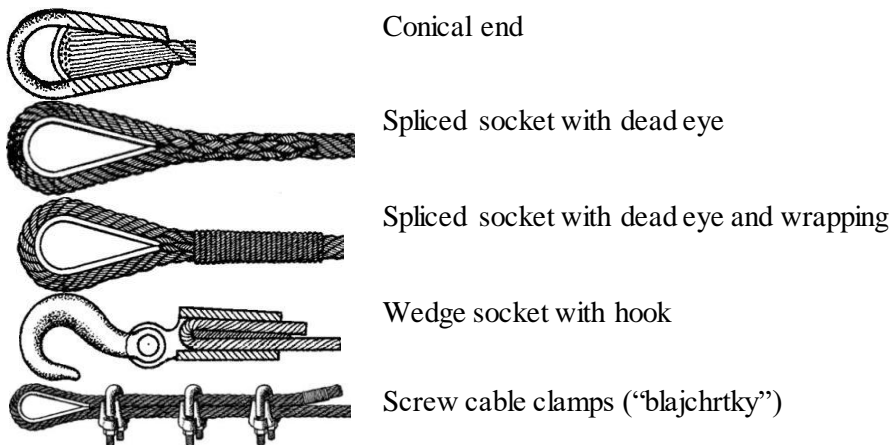
times), or by **long** splicing (cable diameter in the connecting point does not change, length of splicing is min. 1000 d, example: cable Ø 10 mm, length of splicing 10 m, only ½ of the number of strands is spliced, strands removed in the opposite part of the cable are mutually replaced).

**Fig. 54. Connecting cables by splicing**



**Fig. 55. Connecting cables by other methods**

**Ending of cables** is a modification of cable ends with pressed cable ends, conical ends or sockets. Using flat cable clamps ("blajchrtky"), the individual clamps are fixed to the cable at a min. distance of clamp width, altogether 3-8 for cables of common diameters (min. 4-5 for the most used cables of 11-13 mm in diameter), which have to be tightened by a torque of 33 Nm. After a short time of operation at full load, the clamps have to be finally tightened. If they are used to connect cables, a full number of clamps must be on each side of the connecting point; this means that extension requires a double number of clamps as compared with the cable ending! The stirrup of the clamp is to be on the cable end side. When extending cables of different diameters, clamps for a larger diameter are used, and the lower-diameter cable is plaited in order to fill the clamp space.



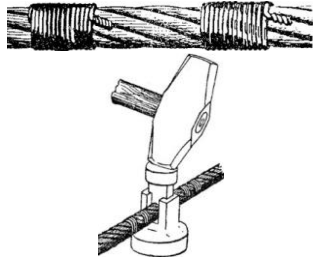
**Fig. 56. Ending of cables**



Clamp stirrup is always on the side of cable end – a full number of clamps is on each side

**Fig. 57. Connecting cables with screw cable couplings**

**Cutting and shortening of cables** in workshops is made by overburning with a burner or by cutting with a cutting saw, in the field most often by cutting with a chisel and hammer. Before cutting the cable, the cutting point must be wrapped with wire on both sides to prevent spontaneous untangling of strands. For the wrapping, a common binding wire of 1.5-2 mm is used, the bandage is tightened as much as possible, the wrapping length is min. three-times larger than the cable diameter, and the wrapping always begins from a to be cable end.

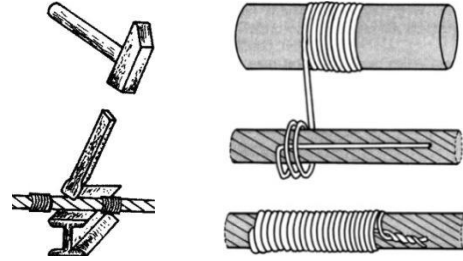


cable wrapping before cutting

two wrappings are made on each to-be cable end

fixture for cutting cable

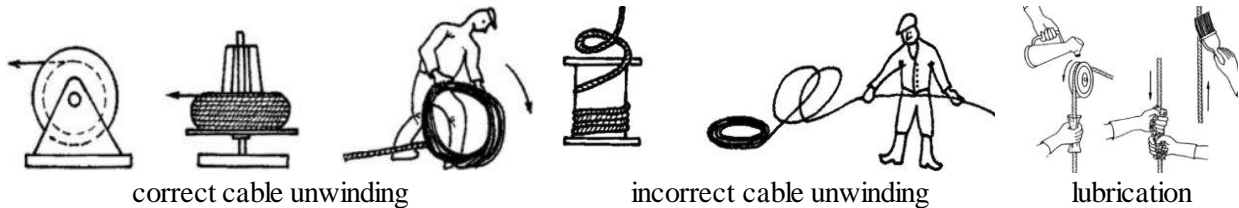
**Fig. 58. Cutting cable in the field**



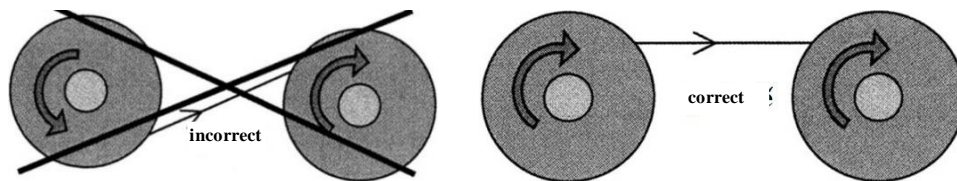
**Fig. 59. Wrapping procedure**

**Care of steel cables**

- regular cleaning and lubrication with a suitable oil to reduce friction and to prevent moisture getting into the cable. Regular lubrication can extend the service life of cable by up to 1/3. Cable core is saturated with the lubricating grease in production, and thus the grease is pressed from inside the cable to middle layers with cable loading. After lubrication, no greasy, sticky stain should remain on the cable surface as it could affect the function of self-locking jaws of tightening systems of cable transport installations.
- storage at dry places, wound on reels (min. diameter of reels = 40-times cable diameter)
- when cables on reels are stored for a longer time, the reels should be turned a little from time to time so that the conservation grease does not drip from them but rather remains inside the cables
- cables should be unwound correctly to prevent loops
- “breaking” of cables by sharp movements should be minimized, and their contact with sharp objects (stones) while pulling should be limited.



**Fig. 60. Care of cables**



**Fig. 61. Incorrect and correct cable rewinding from one drum to another one**

**Signs of damage leading to cable discarding** include strand rupture, nominal diameter reduced by more than 15 %, wear of outer wires by more than 1/2 of their cross-section, rupture of more than 15 % of wires visible on one length of the winding, heavy malformation (flattening to elliptical cross-section) or untangled cable strands, knot or loop, cable breakage, severe corrosion, conspicuous cable extension, blue tint due to hardening.

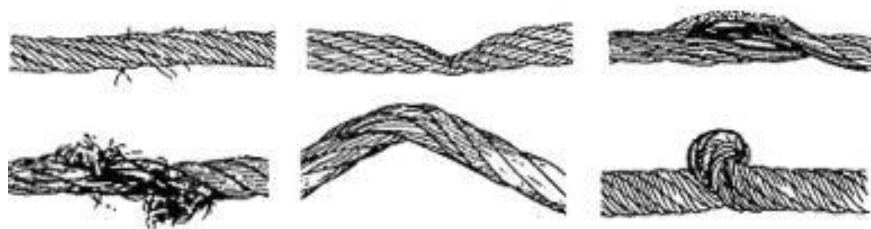


Fig. 62. Some damage to cables leading to their discarding

Number of carrier wires in the outer cable layer (without filling wires)	Number of visible wire breakages			
	lattice cable winding		regular cable winding	
	on the length of 6 d	on the length of 30 d	on the length of 6 d	on the length of 30 d
up to 50	4	8	2	4
51 - 75	6	12	3	6
76 - 100	8	16	4	8
101 - 120	10	19	5	10
121 - 140	11	22	6	11
141 - 160	13	26	6	13
161 - 180	14	29	7	14
181 - 200	16	32	8	16
201 - 220	18	35	9	18
221 - 240	19	38	10	19
241 - 260	21	42	10	21
261 - 280	22	45	11	22
281 - 300	24	48	12	24
more than 300	0.08 n	0.16 n	0.04 n	0.08 n

6 d = 6-times cable diameter, 30 d = 30-times cable diameter, n = number of carrier wires in the outer cable layer

according to FRAUENHOLZ, 2008

Tab. 9. Damage to cables resulting in their discarding

**Chokers** serve to tie the load (tree, trunk, log) and to attach it to the winch drag line (brake cross-bar at timber skidding by horses). **Cable and chain chokers** are used to drag timber, **textile chokers** are used for low-damage fastening of directional pulleys on standing trees.

**Cable chokers** are useful in conditions when the choker is permanently pulled to prevent its release and slipping from the trunk. Permanent tension of chokers can be best ensured by skidding in semi-suspension or up the slope in favourable terrain conditions (chokers are loosened by load hitting against obstacles), on non-abrasive grounds and dragged over shorter distances. They are made of six-strand cables with strength characteristics similar to those of winch cables. A sufficient choker length for thinning is 1 m, a choker length of 1.5-2 m is used for main felling. On one end of the choker, there is usually a hook, sliding hook or cylindrical sleeve; on the other end, there is a spliced eye, metal eye etc. so that a self-locking loop can be created for fastening the load. Chokers with the cylindrical sleeve are provided with a sliding block into which the sleeve is slid, and they are used in the method of choker line.

**Chain chokers** are heavier than cable chokers but can be used in stony terrains, on tracks with counter-gradients (do not tend to loosen) and over larger distances. They are made of link chains from standard and high-strength, wear-resistant alloy and heat-treated steel materials. Strength characteristic of high-strength chain is by the order of 50 kN, safety coefficient 2. In our conditions, the most used shape of eye material cross-section is circular. However, angular shape (square) is used as well, which has a strength increased by 8-9 %, gripping of stem is much better, resistance to wear is higher as well as service life, and its resistance at timber dragging is just slightly higher. On one end of the chain choker,

there is an eye, on the other end, there is a hook or a profiled eye which is narrowed on one end to at least the length of chain width. The profiled eye is usually slid on the terminal eye. Length/weight of chokers is 1.6 m/3.5 kg; 2.0 m/4.2 kg; 2.5 m/5.1 kg. Advantages of chain chokers include the tight gripping of the trunk (with the chain link slotting into the profiled eye so that the choker cannot slip even at released tension), they can be simply shortened using a profiled eye or a hole on the sulky or tractor; shape of chain links allows high chain ductility (chain extension at overloading) and warns operators about the oncoming rupture, some types of chains exhibit ductility of 20 % (extension by 20 cm per length of 1 m), and at skidding down the slope the chain chokers act as brakes.

Nominal diameter of link (mm)	Link width (mm)	Weight (kg/m)	Load capacity (kN)
6	20.0	0.74	13.3
7	23.0	1.00	18.2
8	26.5	1.30	23.9
9	30.0	1.65	30.2
10	33.0	2.00	37.3

Tab. 10. Parameters of standard chains for chokers

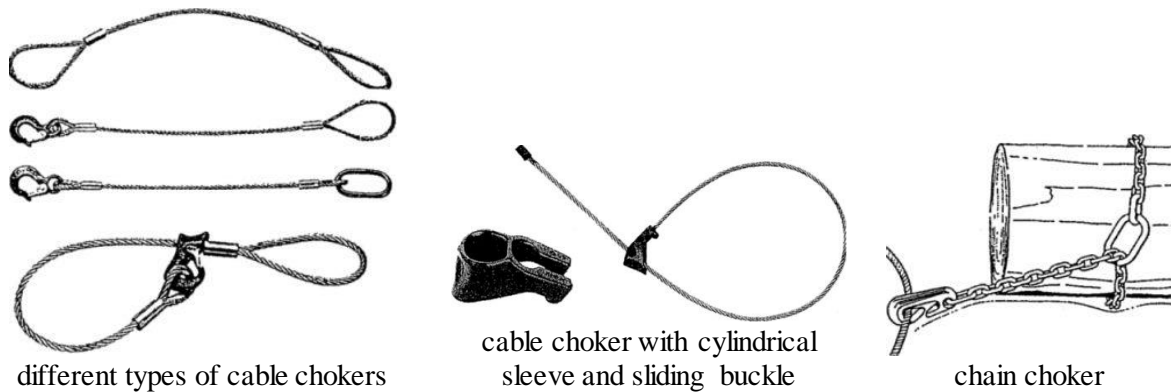


Fig. 63. Chokers

**Textile chokers** are made from an endless bundle of high-strength polyester or other type of fibre, enclosed in protective cover. They are light; their load capacity is high; range of working temperatures is wide (from -40 to +100°C); they protect the surface of trees onto which they are fastened; they are supplied as endless or with eyes; their basic load capacity is 500-30 000 kg, and can be increased by the mode of binding (simple, loop, parallel - twinned); length of endless choker = circumference, commonly supplied lengths are 1.0 m, 2.0 m, 3.0 m to 20 m; load capacity of chokers is expressed by colour and inscription on the choker packaging; they are useful for fastening pulleys and guy lines of cable transport installations onto trees; inappropriate for dragging timber!

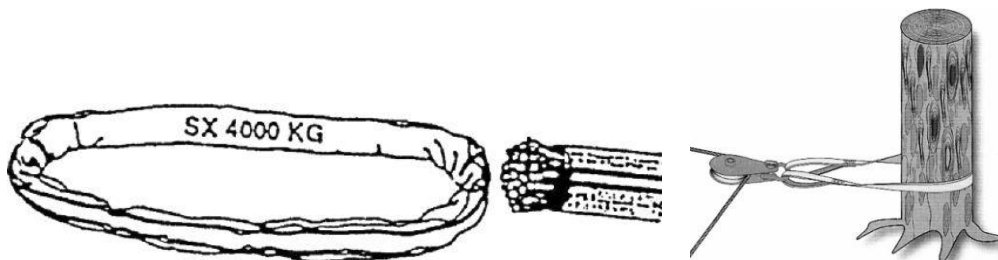





Fig. 64. Textile choker and its use at binding a directional pulley onto the tree

Nominal load capacity in tonnes	Mode of choker binding		
	straight	loop	parallel
			
1	1	0.8	2
2	2	1.6	4
5	5	4	10
8	8	6.4	16

**Tab. 11. Permitted loading of textile chokers in different binding modes**

**Textile ropes** (hemp ropes and ropes of man-made fibres) are as a rule not wound on drums but plaited into rolls.



**Fig. 65. Procedure of plaiting the textile rope into the scroll**

## 5.2 Remote control of forest machines

Direct participation of humans in the control of machines is irreplaceable so far. Operators must be in immediate contact with them, stay in the cab (of cars, tractors, cross-cutting lines, planting machines, etc.), and hold or carry the machines (motor-manual machines power saws, brush cutters, sprinklers). As technical means for choker timber skidding, winches have been representing an exception for several decades. They are used for ground-based primary timber extraction by dragging on the soil surface as well as for timber skidding by cable transport installations.

**Control of winches** of tractors and cable transport installations is possible

- **from the tractor**
  - by controllers situated in the tractor cab
  - by controllers situated on the tractor from outside
- **remote control**
  - by simple methods (chains and stranded wires)
  - by cable-connected controllers
  - by infra-red ray
  - by command radio station.

**Control of winches from the tractor** can be

- **mechanical**, by joysticks connected through the system of draw bars and gears with the control mechanisms of winches (brakes and clutches, TNP winch is a typical example)
- **hydraulic**, by joysticks which are parts of switchboards and valves steering power hydraulic or pneumatic mechanisms of winches (brakes and clutches), or by joysticks interconnected with the switchboards by cable draw bars (bowdens)
- **electrohydraulic**, by means of push buttons and joysticks (electric switches) transmitting the control signals of electric voltage to electrohydraulic switchboards and valves by which power hydraulic or pneumatic mechanism of winches (brakes and clutches) are controlled.
- **electromagnetic**, by means of push buttons and joysticks (electric switches), transmitting the control signals of electric voltage to electro-magnetic power elements controlling the power hydraulic or pneumatic mechanisms of winches (brakes and clutches).

A specific solution of **winch control from the tractor cab** depends on the winch design. Mechanical lever control or control by means of joysticks were usual in older types. Nowadays, the mechanical control is used in simpler winch types, usually with a single drum, integrated with the skidding shield and mounted on the three-point linkage hitch of general-purpose wheeled tractor (UKT). In hydraulic controls, hydraulic distribution systems in the cab are eliminated for safety reasons, controllers remain at the driver's post in the cab, switchboard and pressure oil pipes or hoses are situated outside the cab, and the switchboard is connected with joysticks by means of bowdens. Hydraulic and electro-hydraulic controls are frequent. Control from the cab is useful for lifting load to semi-suspension, for taking the load down and for snubbing. It is however not good for primary extraction of timber from the stand as the driver's view of cleared timber is usually not perfect. Similarly, control from the cab in cable transport installations is possible only if the view of cableway track is perfect. Working with a winch controlled in this way for one operator (driver) is not realistic (low work productivity); a hauler (binder) is necessary although the communication between the two may be inaccurate.

**Winch control from outside the tractor** is by means of electrohydraulic and electropneumatic push buttons situated on the rear mudguard. Control signal transmission to power elements (brake and clutch of winch) is similar to the one described above. Advantage of the control from the tractor outside is in limited driver's getting in and out of the tractor – he can undo the load. Disadvantages are similar as in the control from the tractor cab, and there is an additional risk of injury as the tractor driver is rather unprotected near the moving timber.

**Remote control by simple methods**, by stranded wires or chains directly connected with the power mechanisms of winches (clutch in particular) is simple, functional, cheap and common in the offers of winch producers (e.g. Farmi, Igland, KMB). Winch clutch switches on by pulling the stranded wire, and the cable starts to be wound onto the drum. By releasing the pull, the clutch switches off and the winding stops (thus, it is also a safety element). The reach of the control is given by the length of the stranded wire (ca. 5 m), which is enough to ensure the increased safety of tractor driver who does not need staying close to the winch and may move to the place with a better view of primary extraction track. This solution does not allow a one-man crew either, and can be used in terrains with trees and shrubs only with difficulties. From the technological point of view, this solution represents a simpler analogy of winch control by cable.

**Remote winch control by cable** (e.g. KON 2) is widespread in tractors and cable transport installations powered and towed by tractor. In the transport position, the box with controllers (push buttons and joysticks) as well as the cable of remote control are usually suspended on the tractor mudguard. Before timber primary extraction, the cable is unwound, and the person with the control box retreats to a safe distance from where the track of primary extraction is properly visible (retreating from the machine and staying out of endangered area is important also for the case of accident, cable rupture or tractor overturning). From the command box, control and/or power signals are sent to power controllers of the winch (brake, clutch) by pushing relevant switches. Advantage of the control by cable is a low cost, possibility of controlling more functions (winding, braking, remote start), elimination of receiving parasitic signals, and a possibility to operate the machine from the place of the best view. Disadvantages include a relatively short reach (ca. 10 m) and impossibility of one-man crew – a possible disharmony in the driver-hauler communication still applies.

**Remote control by infra-red ray** is used only exceptionally in tractor winches. Advantage is a favourable price, possibility of controlling more functions (according to device excellence), and a possibility of one-man crew. Disadvantage is a limited reach and the fact that the device can be operated under direct visibility only. The controller sends control pulses that are changed into power signals in the signal receiver situated on the tractor, which are brought to the force elements (electromagnetic, hydraulic and pneumatic valves and switchboards or electromagnetically controlled clutches and brakes).

**Remote control of winches by command radio station** is the most perfect and has been used in tractor winches and cable transport installations for a long time. Popular Czech models of command radio stations include VAW 010 or Lesana 2 made in Tesle Pardubice. The Lesana 2 radio stations operate in the band from 167 to 174 MHz and their reach is up to 600 m. A range of DOS command radio stations

(e.g. DOS 41 TA, DOS 41 DA and DOS 42 LA) is made by TRS Pardubice. Their frequency band of 430 MHz is comparable with the band used by foreign radio stations in the area of wave length of 70 cm. Foreign models on the market are produced for example by Telenot Electronic (types F9 ET, F9 DT), HBC (types Vector 2, FST 508 Orbit), Terra Fernwirktechnik (type FA5-S1, FA5-D1, FAP-X2) etc., and their number of commands is comparable with those made in the Czech Republic, including the help call switch which sends an emergency signal to a defined place.

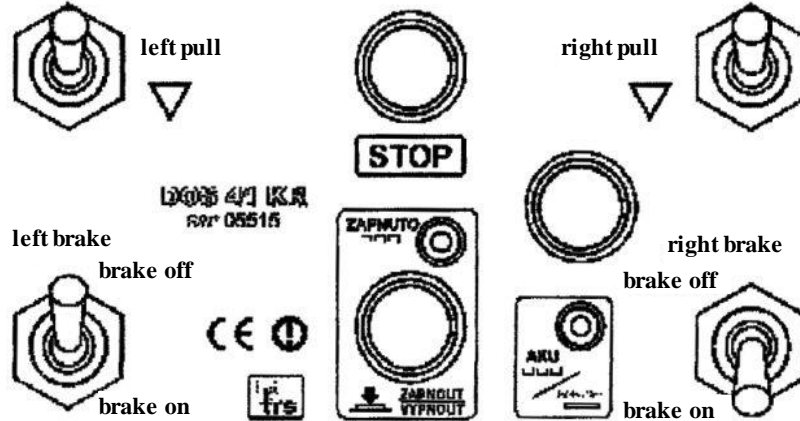


Fig. 66. Panel of the transmitter DOS 41

**Command radio station** consists of two basic parts: transmitter that is carried by the worker, and receiver that is situated in the machine cab. The system features one-way remote radio control with adjustable address without confirmed transmission. Command in the form of data report with the address is sent by the transmitter by means of control (push button or switch). The receiver accepts the data report, and evaluates the address and the report – the command. Transmitted commands are passed over to control circuits of the controlled machine (electromagnetic hydraulic and pneumatic valves and switchboards, or electromagnetically controlled clutches and brakes) through the connector or other interface, which perform the requested action. Transmission loss is evaluated and will cancel the selected commands. At the same time, a number of commands can be transmitted that belongs to the given type. The last command is the emergency STOP, which cancels all the selected commands and brings the machine to a standstill. To cancel this state, the receiver has to be reset (Reset), in some types the transmitter too (important for work safety). The transmitter is powered by the in-built accumulator which can supply energy to the transmitter for one shift on a single charge. The control signal is evaluated by the receiver and amplified into the form of power signal which is then transmitted by means of electric conductors to the force elements. For its operation, the receiver employs electric energy from the circuits of basic machine. The formerly significant risk of receiving a parasitic signal and of incorrect functions of the winch evoked thereby is eliminated in the contemporary radio stations by the combination of carrier frequency and control frequency, and by the unique addressing of both instruments representing the set of command radio station. Costs incurred for the command station are paid back soon either by savings on workers, increased labour productivity or by improved work safety.

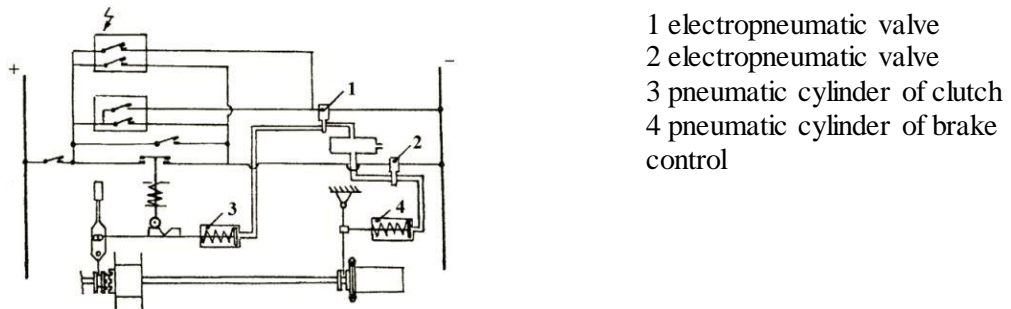


Fig. 67. Schematic of a remote winch control



**Advantages of remote control by command radio station from the technological point of view**

- the device can be controlled from a place of better view than from the machine
- the crew are accompanying the load during primary extraction and thus can stop winding before a collision situation occurs
- at controlling cable transport installations by a command radio station, the power station can be controlled from more places (both by binder from the clearcut and by machine operator)
- integration of logging and primary extraction is possible.

**Advantages of remote control by command radio station from the economic point of view**

- possibility of one-man crew at timber skidding
- possibility of primary extraction from two directions at the same time with one tractor and a crew of two persons (in 2-drum winches).

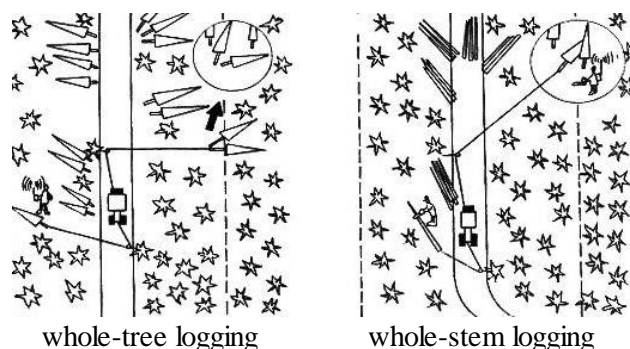
**Advantages of remote control by command radio station from the occupational health and safety point of view**

- the worker is not exposed to vibrations generated by tractor operation
- the worker is at a distance from the source of noise and exhaust gases
- the worker is not exposed to the risk of falling tractor in case of its overturn
- elimination of the hauler eliminates misunderstanding in the communication of two persons in the crew
- timely winch stop (when accompanying the load) prevents collision situations (bumping against stump, standing tree – with uprooting, breakage, cable rupture).

**Safety elements** in remote control systems: Power signal – signal to start cable winding onto the drum, can be sent only at intentional action on the controller (pushed button, moved joystick) both in the command radio station and in all other forms of remote control. For the controller release, a “dead man” principle must function, i.e. that the given power function must be cancelled immediately (stopped operation of winch drums). Only functions that are not power functions – clutch release, can be resolved so that even after the end of the direct touch of the worker on the relevant controller (lever of electric switch) the transmitter continues in sending the signal until the controller is switched to the original position. Advanced command radio stations used to be equipped with the “alarm” function when the receiver blocks the machine if no signal is received within a set time, and activates alarm signal and/or automatically notifies the base workplace.

Conditions for the operation of command radio stations: The spectrum of radio electromagnetic waves is considered to be a natural source the use of which is coordinated both in individual countries and worldwide. For this purpose, the International Telecommunication Union exists that resides in Geneva and is a part of UN. The Union is responsible for the coordination, planning, control and standardization of telecommunications and stipulates rules for radio, telegraph and telephone operations, recording frequencies for individual countries. ITU decisions are binding for member countries and reflected in the national Radio Regulations. The inspectorate of radio-communications or its specialized workplaces is responsible for compliance with the regulations. Their staff registers violation of permit conditions by radio stations and sanctions their operators. Each country guards allocated frequencies and keep them under strict management. Illegal transmitters may put into danger the radio networks of rescue services, fire brigades, civil defence, even air traffic, and this is why the transmission without a permit can be considered a crime. Command radio stations and telemetric radio stations have a delimited part of the frequency spectrum of electromagnetic waves above the upper boundary of short waves, i.e. over 30 MHz that are not used for the commercial radio broadcasting. These stations are determined for the remote control of machines and equipment or for the transmission of data by radio; this means that they are not meant for the communication by voice or image. Operation of command radio stations does not require special qualifications of operators; the only condition is that only radio stations officially approved for operation in the Czech Republic can be used. The regulation treating the introduction of command radio station onto the market is Government Directive no. 426/2000 Sb., stipulating technical requirements for radio and telecommunication end devices. §3 of this Government Directive stipulates in the sense of Act no. 22/1997 Sb. on technical requirements for products that prior to the instrument introduction onto the market, compliance with the basic requirements included in § 2, article 3 of this Government Directive has to be made by one of determined procedures. Declaration about the

compliance of command radio station with the technical requirements for products (with all relevant legal regulations, technical norms) must be along with the operating instructions included in the technical documentation of the radio station. Without them, the radio station cannot be operated!



**Fig. 68. Example of the technological use of remote controlled two-drum winch in logging**

### 5.3 Tractors and prime movers for choker timber skidding

**Tractors and prime movers** occupy the dominant position in ground-based timber skidding. From the technological point of view, they include general-purpose wheeled tractors (UKT) or skidders (SLKT) with wheeled or tracked undercarriage but their applicability is mainly affected by equipment. The machines are equipped with parts necessary for timber skidding either directly by the manufacturer (winches, pushers, hydraulic booms and cranes with grapples in skidders), or basic machines are added adapters later (UKT completion for logging). Nowadays, ca. 70 % of timber volume felled in the Czech Republic is skidded by tractors and prime movers equipped with cable winches, i.e. by choker skidding. Tractors and prime movers primarily operate in tractor terrains, i.e. in terrains safely passable by the given type of tractor and prime mover. Max. slope for SLKT in the Czech Republic is considered 40 %.

**Tractors are used in tractor terrains** at choker timber skidding for

- **primary extraction** of timber by winch cable from working fields
- dragging timber load by tractor – **skidding**
- work on timber landings (**grading**).

**Tractors are used in cableway terrains** at choker timber skidding for

- skidding by dragging bundles of whole trees at right angles to the contour (exceptionally)
- primary extraction obliquely down the slope or along the contour line by tractor winch cable with the position of tractor on the slope road in terrains with gradients above the limit (frequently)
- pulling timber away from the cableway skyline
- combined cableway – tractor timber skidding (cableway skids to forest edge landing (VM), tractor skids from VM to the roadside landing (OM).

**Other applications for tractors** in logging

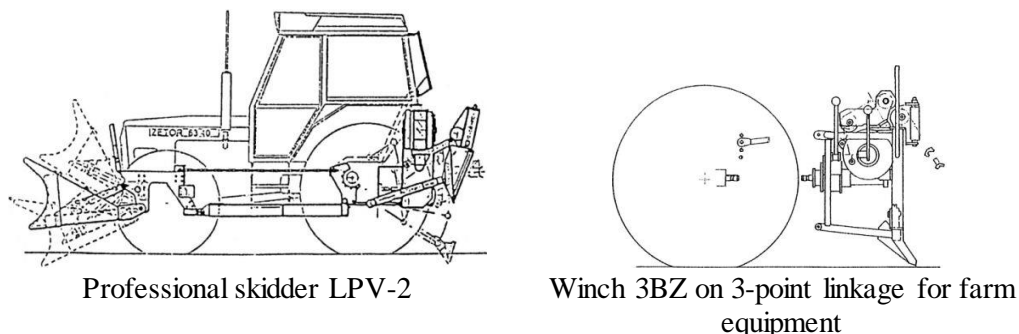
- power stations of cable transport installations
- basic machines of some timber transport units
- towing (traction) means (transport of various substrates including haulage of timber and sawn wood)
- delimiting by branch trimming units
- basic machines of some earth movers and low-cost processors and harvesters.

### Equipment of tractors and prime movers for ground-based choker timber skidding

Modification of farm tractor (general purpose wheeled tractor – UKT) for timber skidding has two levels. **Professional completion** is UKT reconstruction into special forest machine for timber skidding after which the machine is unable to perform farm and other works without rebuilding. Advantage is a complete tractor equipment with components needed for skidding (winch – usually remote controlled; complete skidder shield, pusher) as well as the fact that the winch is situated as close to the rear axle as possible, by which a shift of gravity centre towards the rear axle due to loading with the winch and the towed burden is minimized. The modification of UKT for use as a forest tractor should further include

- modification of engine vat by fitting it with a deeper sump for lubrication oil (to ensure engine lubrication when working on slopes)
- selection of proper transmission – 2 x 4 (5) gears are enough, at the best with reverse and drive inverter
- undercarriage protected with vat and reinforced, wheel rims should be reinforced with a steel bar welded along the circumference and the valve should be protected by steel cover
- the cab should meet international standards: ROPS Protection at tractor overturning, FOPS – Protection against a falling object, and OPS – Protection against penetration of objects from sides.

In professional forestry use, the tractor becomes de jure a single-purpose machine which is defined by international standard ISO 6814 as skidders. This changes the vehicle category from tractor to self-propelled machine and hence some requirements for traffic safety and technical competence. **Farm equipment** of UKT is simple, fast to mount and dismount a winch suspended on the three-point linkage of hydraulics, i.e. the tractor is not blocked by logging equipment for other purposes. The winch is usually a one-drum type, with lower traction, without remote control (or with a simple control by stranded wire only), and usually forms one whole with the skidder shield and protective net. The tractor is usually not equipped with a pusher, reinforced undercarriage or complementary protective elements in the cab. Winch suspension on the 3-point linkage shifts the machine gravity centre backwards, which becomes even more evident with the load; this is how the relieved front axle may result in lost control of the machine. Load capacity of the rear axle is by 30 % lower than in the professional skidder (load weight must be proportionally lower), and thus the efficiency of UKT with farm equipment is lower in comparable conditions than that of the professional machine i.e. purpose-built skidder. A positive parameter of UKT with the farm equipment is the purchasing price which is considerably lower than that of professional skidder. Division into professional skidders and farm equipment is only indicative as there are also technically sophisticated multifunctional adapters connected to the tractor by means of three-point linkage such as **winches with travel wheels** that increase the winch transport capacity at skidding by capturing a part of the load weight. This is why a range of parameters has to be taken into account before an adapter can be referred to as farm equipment.



**Fig. 69. Different levels of equipment for skidding by UKT**

**Winches** represent the **main elements of the equipment** of tractors and prime movers for choker timber skidding, increasing their action radius in terrains that are not fully passable. They can be used at intermediate or main harvesting as well as salvage felling. In improvement and selective felling, they serve to secure the cut-off tree and to guide it to the desired direction of fall, to extract trees (stems and logs) to the line, to assemble the load and to skid timber in semi-suspension with a possibility to overcome difficult sections of skidding line by snubbing by the winch/trees. In clear cutting, they serve for load yarding and assembly (often by a method of choker line) and for timber skidding in semi-suspension with a possibility of snubbing. In salvage felling with breakages and windthrow, they serve for disassembling and pulling of cut trees and their parts to open areas, skidding, securing windthrow roots against excessive movement during their cutting off etc. They can be used for uprooting trees, own extraction, extraction of another vehicle, and even as a basis of cable systems if the capacity of drums is sufficient. Loading and unloading of timber is also one of common applications for winches. Winches are distinguished according to the

- **number of drums** into one-drum, two-drum and multi-drum
- **undercarriage design** into sledge-type (self-propelled, towed), self-propelled with own undercarriage

- **mounted and attached to drive machine**, most often a tractor = **tractor winches**
- **drive of drums** – with own engine, without engine, mechanical drive, hydraulic drive, other drive
- **control** – direct, remote (with short or long-distance reach)
- **purpose** – for ground-based skidding (tractor), cableway.

**Main parts of winch** are the drum (more drums), clutch, transmission, brakes and supporting structure. Winches are usually of one- or two-drum types, mounted on the rear side or tractor transmission. There are also types in front of the front axle, which is useful for tractor load final drive but connected with the problem of attaching the pusher/shovel – this is why the concept is not used frequently. **Drum** consists of a drum cylinder, shaft and flanges. Power is transmitted onto the drum as a rule mechanically from the PTO shaft (by means of sprockets or in combination with roller chains), less frequently hydraulically. During timber skidding, a possibility of blocking the drum by a brake of various designs must exist. **Drum capacity** = length of wound cable, depends on the type of device and cable diameter. Tractor winches have a capacity from 60-100 m, cableway winches from 300-500 m. Cable attachment to the drum should be strong enough for the cable not to be ripped out by human force out from the drum when being unwound, and at the same time to be easily ripped out from the drum without a danger of the tractor overturning. The strength of cable fastening to the drum should be ca. 2 kN, and if there are min. 3 threads of cable on the drum, it is possible to utilize full traction of the winch. There are 5-10 cast steel **sliders** pulled on the tractor winch **cable**, into which chokers bound on the skidded timber are stuck. The cable ending is important as it is the best wedge end cap of guaranteed strength. At skidding, the sliding buckles lean against the end cap and transmit the traction force onto the chokers. Cable ending by knotting is not allowed. **Clutches** ensure the turning off drums while running the winch and at pulling the cable into the stand. They are usually mounted on the drum or in front of drum drive gears. In the simplest winches, a combination of clutch on the tractor is used, which switches off the separate drive shaft of the winch, by which the winch driving system is lightened for a short time, and the winch gear clutch can be disconnected (or connected) according to circumstances. Clutches are single-plate, multi-plate, conical, of jaw-type and belt-type. The mechanism of clutches is controlled electro-pneumatically, hydraulically, electro-magnetically or mechanically. **Transmission** serves to change gears and hence the traction of cable being wound. Using adjustable transmissions is not common in current winches. **Brakes** are of belt types (on drum flanges or on countershaft) or shoe type (on the inner side of drum flange or directly inside the drum). Winches for gravity launching of the load have also air vortex brakes whose rotations can be continually changes, in simple older winch types the brake is replaced with a manually controlled ratchet. The cable **controller** is a mechanism with which the tractor winch can be equipped and which improves the placement of the cable onto the drum. There is screw, twin-pulley cable controllers etc. Their use is not common in current winches. **Basic parameters** of winches are minimum drum diameter, capacity of cable on the drum, maximum, mean and minimum traction force, course of winding speed etc.

### Characteristics of some Czech-made winches

**Winch TNP** (tractor winch for skidding) is one of the oldest and still used types. It consists of a cast steel transmission box with a double transmission by front sprockets, drum and pulley cable controller. It is screwed to the rear part of tractor transmission with a clamping plate. The drum axis is parallel to the tractor axis and the cable is drawn onto the drum by the guide pulley fixed to a pivot under the winch on the left side. From the guide pulley, the cable is brought onto pulleys of a cable stacker situated on the ends of the arm swivelling around the pivot. During the cable winding, the arm turns by the force of cable rolling on cable threads wound on the drum. Unwinding is prevented (braked) by the ratchet (controlled by manual brake) slotting into gearing on the drum flange. Winch TNP can be modified by electro-pneumatic mechanisms also for remote control. Maximum traction is 37 kN, average 26 kN, average speed of cable winding  $0.8 \text{ m}\cdot\text{s}^{-1}$ , drum capacity of cable  $\varnothing 12.5 \text{ mm}$  100 m.

**Winch TUN-40** (general-purpose tractor winch) is based on the TNP type and is controlled electrically by hand or remotely. Maximum traction is 40 kN, cable  $\varnothing 14 \text{ mm}$  is up to 60 m.

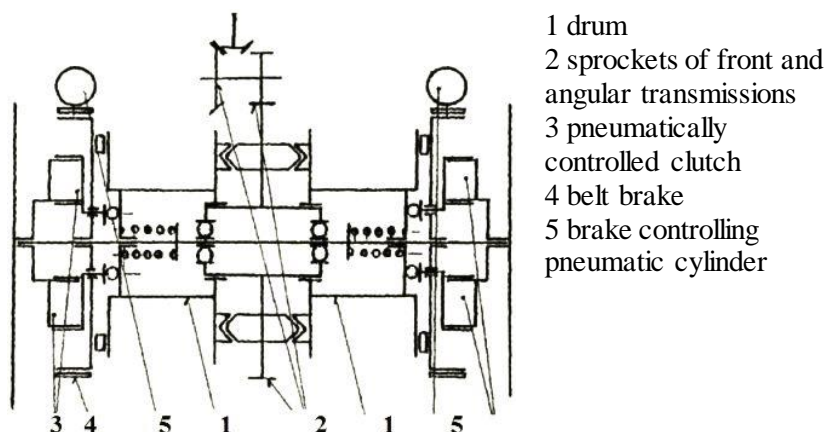


Fig. 70. Schematic of double drum winch

- 1 drum
- 2 sprockets of front and angular transmissions
- 3 pneumatically controlled clutch
- 4 belt brake
- 5 brake controlling pneumatic cylinder

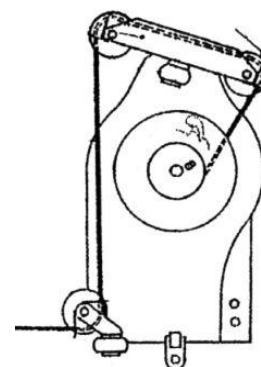


Fig. 71. Double pulley drum controller TNP

**Winch DTN-4** (double-drum tractor winch) has winch drums perpendicular to the tractor axis; the tractor is equipped with a folding skidder shield and pusher. The winch is screwed to the tractor final drive by two consoles – the upper one being fastened to the flange of the cover of hydraulic system and the lower one on the rear of final drive. The winch is powered from the tractor PTO shaft with rotations of  $540 \text{ min}^{-1}$  through the worm gear with the ratio of 11:1. Torque is transmitted onto the shaft with carriers on which there are band clutches that engage on the inner cylindrical surface welded on the drum flanges which rotate freely on the shaft protruding from the transmission box. On the shaft ends, there are carrier discs with a band clutch. The clutch belt is stretched by the pneumatic cylinder through the lever mechanism and pushed against the inner friction surface of drum. Belts of the brakes are pneumatically pushed onto the outer side of the clutch drum, one end of which is attached to the winch case. Each drum is controlled separately electropneumatically. Pressure air is brought to pneumatic cylinders by electromagnetic valves so that either the cable is wound up (clutch switched on) or unwound (released clutch and brake). If the drums do not rotate, they can be braked by belt brakes. From the drum, the cable is led through the nozzle (guide rollers) of skidder shield which is a vertical rectangular shield movably mounted behind the tractor rear wheels. The shield is provided with two cable nozzles and can be hydraulically run to the ground and lean against it, by which it can serve as a support to capture force response of skidding line during timber extraction. Tractive force of each drum is max. 40 kN, speed of cable winding  $0.55 \text{ m}\cdot\text{s}^{-1}$ , capacity of drums is 200 m of cable  $\text{Ø} 12.5 \text{ mm}$ . Thus, the winch can serve also to drive a cable system of up to 100 m in length.

The Czech-made **winch GOLEM 30** is an example of a winch mounted on the three-point linkage of tractor. It is an aggregate of one-drum light-weight winch with the skidder shield for piling wood in decks to a height of up to 0.7-1 m. Winch drive is mechanical from the PTO shaft 540 rpm, control from the cab and from outside by control box with a cable (5-10 m) by radio station. The winch has a clutch and brake of identical design with electric control, maximum winding and braking force can be adjusted by regulator on the control box according to the type of logging (tractive force in improvement felling should be limited so that only individual pieces would be extracted), diameters and cable wear. Clutch and brake are of the friction type and do not require any adjustment of lining during its service life. The winch frame is mounted to a net structure to protect the cab window against the penetration of cable or another object. On the winch sides, there are boxes for chokers, chains, pulleys and protective collars for pulleys, which means that all aids and implements can be placed on the aggregate. The winch weight is 300 kg, tractive (braking) force on the drum core is 14-30 kN (adjustable), drum capacity is 80 m of cable  $\text{Ø} 10 \text{ mm}$ , winding speed  $0.7\text{-}1\text{m}\cdot\text{s}^{-1}$ , shield reach below the base level 120 mm. The Golem winch is manufactured also in Version 431, which allows its mounting on the tractor final drive and is used in combination with the mountain support.

**Winch 3 BZ** is similar as the above winch with its utility properties; it is integrated with the skidder shield and controlled manually from the cab outside. Traction is 34-42 kN, winding speed  $0.6\text{-}0.9 \text{ m}\cdot\text{s}^{-1}$ , drum capacity 70 m of cable  $\text{Ø} 11.2 \text{ mm}$ .

**Winch LPV-2** is of one-drum type with electromagnetically controlled jaw clutch and brake, with the adjustment of maximum tractive and braking forces, overload protection and automatic drum stop at discontinuation or end pulling cable while idling. Control is from within or outside the cab by a push button box connected with the control unit by cable. Its safety control system can be equipped with a command radio station. Capacity of the cable Ø 11.2 is 55-60 m. Alternative cables can be Ø 8-12.5 mm with the corresponding adjustment of tractive and braking forces. The winch is mounted to the tractor final drive and can work with a skidder shield.

Machines of LARIX series, manufactured by the Research Station of Forest Training Enterprise Křtiny, Mendel University in Brno, have winches of a progressive design. **LARIX Kombi** is designed as a basic machine for the cable system but can be also used as a tractor winch.

All winches can be mounted on the tractor as part of **logging equipment** (completion) which also includes front pusher and chassis protective cover. Examples can be types LPV-2 and FAGUS 420. **Logging completion FAGUS 420** is equipped with a double-drum winch mounted on the tractor final drive, folding shield, protective vat and front pusher. The winch is controlled electropneumatically and has a belt clutch and brake. The folding shield has a double cable nozzle and its lifting force is 25 kN. The tractive force of winches is 42 kN, drum capacity 60 m of cable Ø 11.2 mm. Speed of cable winding 0.62–0.88 m.s<sup>-1</sup>. Resistance of idle run is 60–80 N. Front pusher is 1 530 mm wide, max. lift is 1 270 mm, lifting force 10 kN. An example of foreign winches can be **farm winch** on the three-point linkage **FARMI JR 351** of similar design as Golem 30, and its parameters are similar, too: integrated shield, traction 35 kN, cable capacity 65 m. Another example is the twin-drum winch of **higher performance class IGLAD 9002 Maxo TL** with tractive force max. 90 kN, which can be mounted on the final drive (in logging completion) or on the three-point linkage of high-performing tractors. Capacity of cable Ø 13 mm is 110 m. **TIGER RW 80 is a winch with travel wheels** mounted on the tractor three-point linkage, provided with a single-axis undercarriage on which it relies when skidding. It has two hydraulically powered drums. Traction is max. 80 kN. Capacity of cable Ø 12 mm is 120 m.

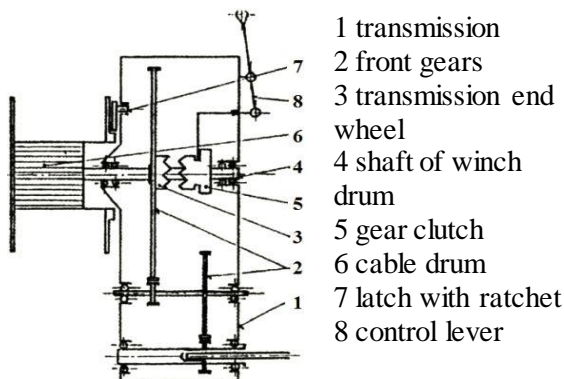


Fig. 72. Schematic of TNP winch



Fig. 73. Double-drum winch DTN-4 with turret

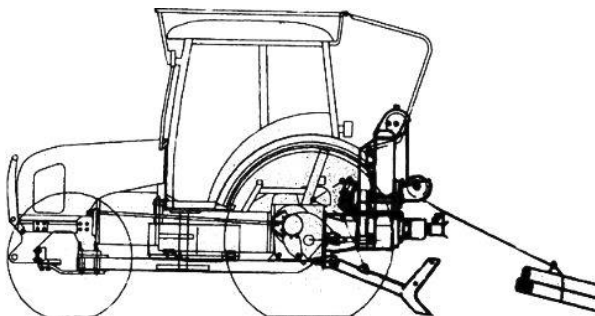


Fig. 74. Tractor with Golem 431 winch and mountain support

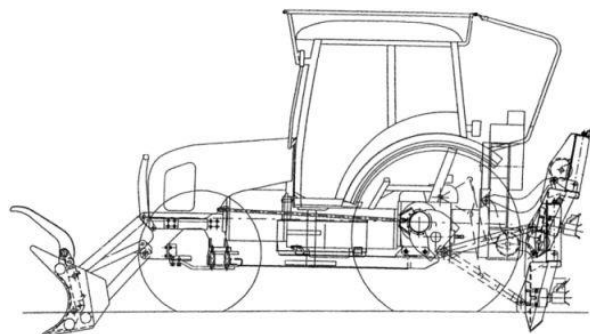


Fig. 75. Professional completion FAGUS 420 with low pusher



Fig. 76. Winch TIGER RW 80 with travel wheels

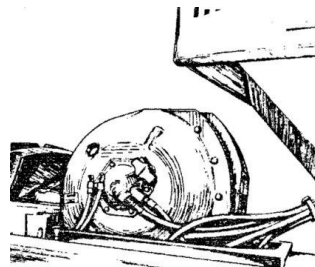


Fig. 77. Hydraulic winch on SLKT

**Forest wheeled prime movers** have one-drum or two-drum winches mounted in front of the trestle or boom. Winches on forest wheeled **prime movers of LKT series** have a max. traction of 60 kN and length of cable  $\varnothing$  14 mm up to 80 m

- on LKT-81 double-drum winch with hydrostatic drive with the in-built lamellar clutch and dry brake
- on LKT -90 A double-drum winch with mechanical drive
- on LKT-90 B one-drum winch with mechanical drive.

Examples of **winches on foreign prime movers**:

- forest wheeled prime mover **John Deere 360 D** with the hydraulically controlled one-drum winch with a max. traction of 140 kN, 54 m of cable  $\varnothing$  19 mm, and winding speed  $0.9 \text{ m}\cdot\text{s}^{-1}$
- forest wheeled prime mover **HSM 805** with the electro-hydraulically controlled double-drum winch with a max. traction of 80 kN, 110 m of cable  $\varnothing$  12 mm, winding speed  $1.0 \text{ m}\cdot\text{s}^{-1}$ .

### Other components of the logging versions of tractors and prime movers

**Firm skidder shield** serves to lean the load against at skidding timber in semi-suspension and protects the rear part of tractor and tyres against damage by load. It prevents transverse swaying of the load and allows its horizontal turning. It guarantees that the load tightens chokers under all circumstances. The shield shape and tilt as well as the position of the nozzle of brought out cables must suit these functions.

**Tilting skidder shield** performs the functions of the firm shield; in addition, it stabilizes the tractor during primary extraction, lightens brakes, prevents the load from slipping under the shield when assembling the load on the slope, and allows to pile and trim stem ends on the landing.

**Cable nozzle** leads cables from the winch above the shield into position that guarantees the contact of load front with the shield eliminating excessive tension of chokers when cornering. In the firm shield, the nozzle is shifted further to the back than in the tilting shield to prevent the load from slipping under the shield. Dimensions of cable nozzle are to allow the passage of cable with sliders and chokers suspended in both directions. The distance between the winch and the nozzle is as big as possible for acceptable laying of cables on drums. **Retractable cable nozzle** is attached to the shield by a telescopic member, moved by the hydraulic cylinder, which allows to lift the butt ends of trees to a height required for their insertion into the branch-trimming machine from above.

**Front-located hydraulically controlled blades (pushers) and stacking blades** are mounted on the front part of general-purpose wheeled tractors (UKT) and prime movers for timber skidding. Front pushers can not only roll timber onto the decks but lift it, too; stacking blades are similar to dozer blades and displace timber by rolling and shifting. These adapters serve to work on decks and landings, stacking, rolling up and displacing logs and levelling the surface of lines. Their basis is a shovel (blade), mounted as a tilting pusher or as a firm blade between two longitudinal swinging lifting arms, the blade in the stacking loader is additionally equipped with a finger (fingers) pushing the load into the shovel from above. All movements are powered by the hydraulic system. Pushers are distinguished by the height reach into low – elevation max. 120 cm, and high – elevation 240 cm above the ground. Stacking blades are ranked with the low pushers. The mounting of front pushers and stacking blades on UKT purposefully adds load onto the front axle and this is why it does not usually aim at lightening their construction. The rear UKT axle, loaded with the winch, shield and load lightens the front axle, which may cause a loss of tractor controllability and even lifting of the front axle at machine starts and travel up the hill. In farm ploughing tractors, the problem is solved by the ballast burden on front wheels or by

the cast iron load in front of the cooler. Thus, the technological device – front pusher purposefully puts into balance the load on the UKT front and rear axles. Nevertheless, in frameless constructions of UKT, the additional load on the front axle causes increased stress of monoblock (transmission) which has to be reinforced by continuous bolts. In more recent tractors, they are led outside the cab but in older types that are still in use, they limit the cab space. However, even this reinforcement of construction cannot prevent rupturing of the transmission box if the technique of timber skidding is inappropriate – release of the load by a sharp start when the tractor stands up on the rear wheels and then the front axle falls onto the ground. **Stacking support**, used in older and simpler tractor equipment performs the function of stacker and partly skidder shield, fixing the tractor at primary extraction. It is mounted onto the rear part of the tractor instead of lower arms of 3-point linkage, and it consists of two longitudinal swinging arms connected with a crossbeam with spades (spikes) that are pushed into the soil when the support is down. The up and down position of the support is controlled by tractor hydraulics.

**Aids for choker timber skidding** came to existence partly already in the past with the aim to **reduce traction resistances**, or to transform a part of traction resistances into rolling resistances: e.g. caps; skis; skidding pans; skis with swivel bunk; sulkies with bunk or logging arches carrying a third to two thirds of the load and partly lightening the rear axle of the tractor but with problems in bends (easy overturning). Unlike in foreign countries, these aids are little used in the Czech Republic.

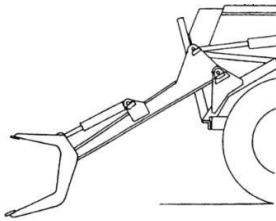


Fig. 78. High stacker

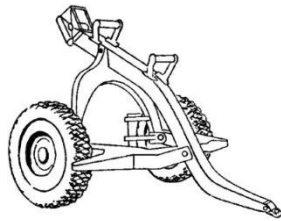


Fig. 79. Tractor sulky

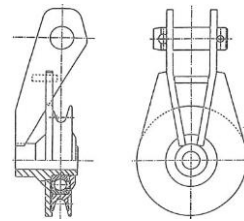


Fig. 80. Open pulley

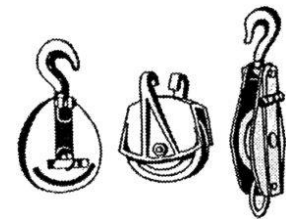
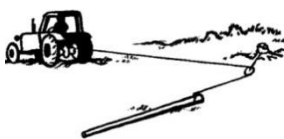


Fig. 81. Opening pulleys

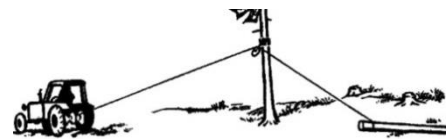
**Directional and height pulleys** are installed on trees with textile chokers for skidding in difficult-to-access terrains, at by-passing obstacles and to reduce damage to standing trees. **Power pulleys** with chokers of relevant size multiply tractive force (practical theorem is that the carrying capacity of choker by which the pulley is fastened to the load must be at least four times higher than the tractive force of the winch) when releasing frozen stems, skidding of particularly big pieces, overcoming a steep slope (primary extraction from ravines), rolling out decks etc. Usually, a simple power pulley is used, which doubles the tractive force, but a **hoist** can be used too. The maximum load of the directional pulley corresponds to maximum traction of winch and load coefficient. Resulting load is transmitted also on the choker and anchor tree. Those have to be dimensioned accordingly! In all pulleys, minimum pulley diameter must be respected as well as pulley groove radius in relation to the diameter of cable used. Ideal width of pulley groove is 1.06-1.08 of cable diameter. At a greater width the cable is deformed elliptically into width, and at a smaller width it becomes deformed on height. This means that in cable transport installations, the crew must have a relevant set of pulleys for each cable diameter! **Opening pulleys** with a folding sidewall are used to insert the cable into the groove after which the sidewall is closed. Directional pulleys can also be with an open sidewall – **open pulleys**. A hoist effect is obtained if one pulley (or more pulleys) moves along with the load. The hoist is mostly used to tension the skyline of cable transport installations (see Chapter 21). In such a case, it is inserted between jaws holding the skyline and anchor. In order to have the loss due to friction of cables in pulleys as low as possible, careful maintenance is a must. When the cable is put into the hoist, its crossing must be prevented and the sequence of threading loops into outer and inner pulleys must be observed to reduce torsional forces in the cable, which cause twisting of the hoist.



Directional pulley



Power pulley



Height pulley

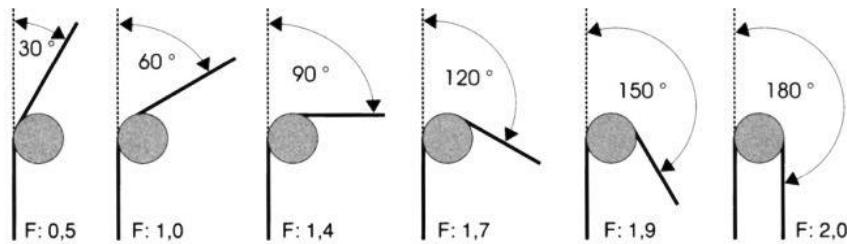
Fig. 82. Technological use of pulleys



Cable deviation from straight line	Load coefficient F	Traction of winch e.g. 50 kN (5 t)	Resulting load on pulley t
30°	0.5	5 t	2.5 t
60°	1.0		5.0 t
90°	1.4		7.0 t
120°	1.7		8.5 t
150°	1.9		9.5 t
180°	2.0		10.0 t

According to FRAUENHOLZ, 2008

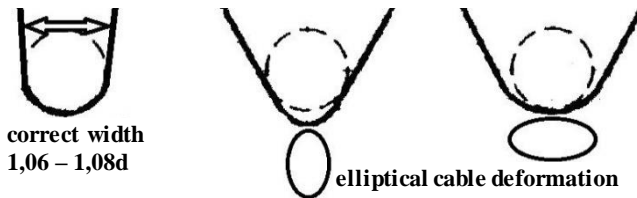
**Tab. 12. Resulting pulley load according to the angle of cable deviation on the pulley**



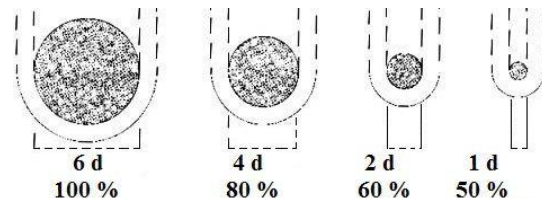
According to FRAUENHOLZ, 2008

**Fig. 83. Coefficients of pulley load according to the angle of cable deviation on the pulley**

Load carrying capacity of cable decreases with the cable bending over small radii such as pivots of shackles. Full load carrying capacity of cable is retained only when the pivot diameter (inner pulley diameter) is equal to six-times cable diameter or more. With the pivot diameter being the same as the cable diameter, the load carrying capacity is reduced by half. Moving cables are stressed by alternating counter-bending. In terms of their service life, it is therefore useful to use as large diameters of drums and pulleys as possible. If we consider the service life of cable as 100 % at a winch drum diameter of 400 mm, then a drum diameter reduced to 160 mm would mean service life of cables reduced to 5 % !



**Fig. 84. Ideal and inappropriate pulley groove width**



**Fig. 85. Cable load carrying capacity in dependence on the inner pulley diameter**

**Workflows at choker timber skidding by tractors and prime movers**

The choice of choker skidding variant depends on the logging method by which the form of skidded timber is given: logs in the assortment method, whole or crosscut trunks (transport lengths) in the tree-length logging method, and whole trees with crowns and branches in the full-tree logging method. Choker timber skidding by special forest prime movers is similar to choker timber skidding by UKT. With respect to higher traction abilities, it is used in the main felling (usually the method of choker line), and the crew has two members (SLKT are not always equipped with the remote winch control). Workplace arrangement derives from the chosen means (width of lines, radii of bends, size of roadside landing). According to the means and work methods, we distinguish choker timber skidding by tractor or by prime mover

- crew of two members
- crew of one member and manually controlled winch
- crew of one member and remotely controlled winch.

Depending on local conditions, any of the above methods can be as an alternative replaced by skidding individual logs or by the method of choker line.

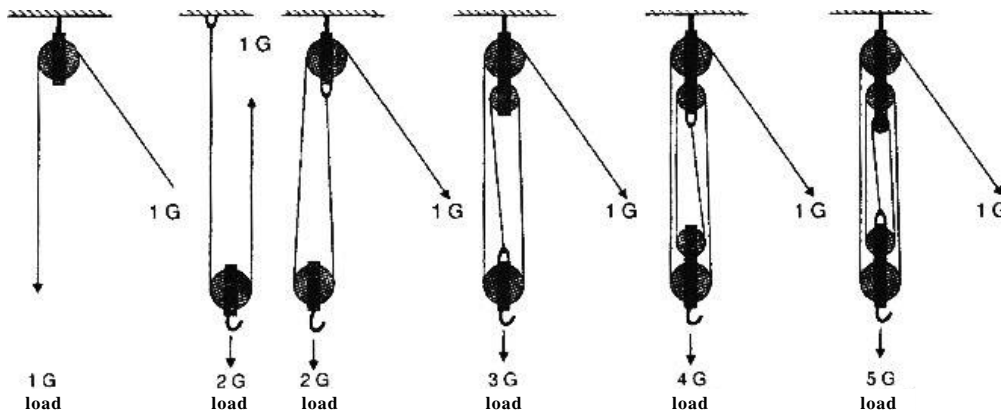


Fig. 86. Principle of the hoist (multiplication of forces)

**Skidding of timber** consists of the following **basic operations**:

- primary extraction of timber from inside the stand
- load assembly
- skidding of timber (by dragging or forwarding)
- placement of timber at the deck

Procedures for binding chokers, by-passing standing trees and obstacles are presented and illustrated both in this chapter and at other relevant places of this textbook. At timber skidding by tractors, the choker is fastened to the log first, and only then the choker is fastened to the skidding line. As the tractors are used for skidding logs of larger volumes, a tucking hook is used to tuck the choker under the log. Rudiments of occupational health and safety (prohibited manipulation with cables, chokers, pulleys and load during the cable pull; staying outside danger area; prohibited release of frozen and stuck logs by jerky movements of cables) must be respected.

**Skidding of timber by tractors and prime movers with a crew of two persons without winch remote control**

**Skidding of individual pieces** consists of the following operations:

- optimum position of tractor on the skidding line
- securing the tractor against unwanted movement (brakes on, shield or mountain support down) and release of cable
- securing the direction of cable guidance by directional or height pulley
- work of assistant (cable fastener)
  - carries the choker while pulling out the cable to the determined piece
  - wraps the piece around with the choker and fastens the choker to the cable
  - withdraws to a safe distance, signals to the tractor driver that winch should be switched on
  - monitors the skidded piece from a safe distance, warns about obstacles, and in collaboration with the tractor driver
  - gives proper direction to the skidded piece after cable pull stop
  - after pulling, he signals to the tractor driver to stop pulling, disconnects the choker, and pulls the cable to another piece to repeat the procedure
- the cable can be pulled out by both workers together (at larger distances, up the hill).

**Skidding of timber by the method of choker line** is used primarily in the main felling when the winch cable on which more pieces (stems, logs) are connected by slider bolts by means of chokers, more pieces (whole load) can be pulled out at the same time. An increased risk of damage to standing trees exists in the improvement felling but even there the skidding by choker line can be used in logs produced of one stem. The workflow consists of the following operations:

- tractor driver will secure the tractor at a suitable place and will release the cable
- activities of assistant (hauler, cable fastener)

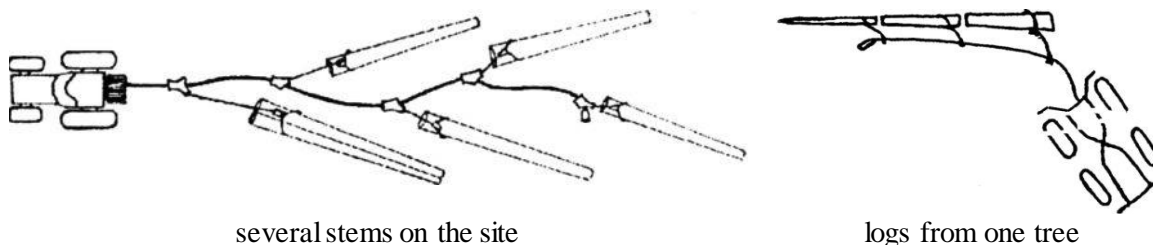
- carries the necessary number of chokers, pulls out the cable and proceeds to pieces to be pulled out
  - on the way, he throws aside chokers to pieces determined for pulling
  - proceeds to the most distant piece, fastens the choker and snaps it into the slider clamp of skidding line
  - on the way back, he deflects the skidding line to individual pieces, shifts slider clamps on the line and gradually connects the pieces to the cable (similarly as the first piece)
  - signals to the tractor driver for switching the cable pull on
  - monitors the course of skidding from a safe distance, and similarly as in the above case, corrects the procedure in collaboration with the tractor driver
- if the volume of skidded timber is lower than the permitted load, the procedure is repeated; otherwise the tractor will skid timber onto the deck.

### Skidding of timber by tractors and prime movers with a crew of one person

In this variant, the tractor driver is at the same time both machine operator and helper. Timber can be skidded by one piece or by using the choker line. The choice of workflow depends on the method of winch control – manually or remotely.

#### • skidding by manually controlled winch

- tractor driver puts the tractor at a suitable place and secures it against unwanted movement
- operator releases the winch cable drum and gets out of the cab
- operator pulls the cable to the piece (pieces) to be skidded and fastens it to the cable by choker
- then operator returns into the tractor, switches on the winch drive and monitors the course of skidding
- if the piece becomes stuck, operator switches the winch drive off, releases the cable, walks to the piece, releases it by permitted way or directs it
- operator returns into the tractor and continues in winding
- when the piece (pieces) is pulled to the tractor, operator disconnects it and the procedure is repeated



**Fig. 87. Skidding of timber by the method of choker line**

#### • skidding by remotely controlled winch

- tractor driver puts the tractor at a suitable place and secures it against unwanted movement
- operator puts on the standby state, releases the winch cable drum and gets out the cab
- if not made earlier, operator performs the functional test of the device
- operator pulls the cable to the piece (pieces) to be skidded, and fastens it to the cable by choker
- then operator withdraws to a safe distance, switches on the winch drive and monitors the course of skidding
- if the piece becomes stuck, operator switches the winch drive off, releases the cable, walks to the piece, releases it by permitted way or directs it
- operator returns to a safe distance, switches the winch drive on and monitors the course of skidding
- when the piece (pieces) is pulled to the tractor, operator disconnects it and the procedure is repeated.

Note: With a crew of two persons, the procedure is similar; each of the two has a command radio station of his own and controls one drum.

### Load assembly and timber skidding

- individual pieces are bound into bundles on the winch skidding line by means of chokers
- the load is bound with butt end or top end in travel direction
- load size depends on the machine, terrain, direction, route inclination and shape
- load is somewhat lifted on the winch cable or leaned against the skidder shield
- the winch is put on brakes
- the load dragging (skidding) takes place along with the machine travel.



Fig. 88. Overcoming an obstacle by lifting the load

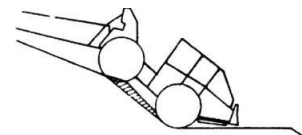


Fig. 89. Modification of ramps

### Stacking timber on decks

Having arrived to the landing (deck), the tractor stops, the winch cable is released, chokers of the dragged load are disconnected, in the case of sorting its parts only. The tractor moves forward a bit, the cable with chokers from the disconnected load is pulled out, and in the case of sorting, the procedure is repeated in other parts of the load. Handling is usually done in between (crosscutting of stems into logs). When the whole load is unbound, the tractor driver winds the cable on the drum and continues in piling the pieces onto the deck. This can be done by the skidder shield when the tractor reverses to the deck while piling the pieces; by means of mountain support (similar to the above); by the front-located hydraulically controlled blade (pusher) by which the pieces can be grabbed, lifted and stacked (some types of pushers can even transport the pieces); as well as by the stacking blade. These mechanisms can be also used to even the ends of decks. Timber can be rolled up also by the winch cable using a directional pulley.

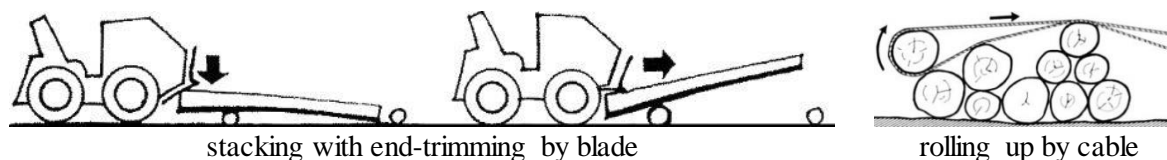
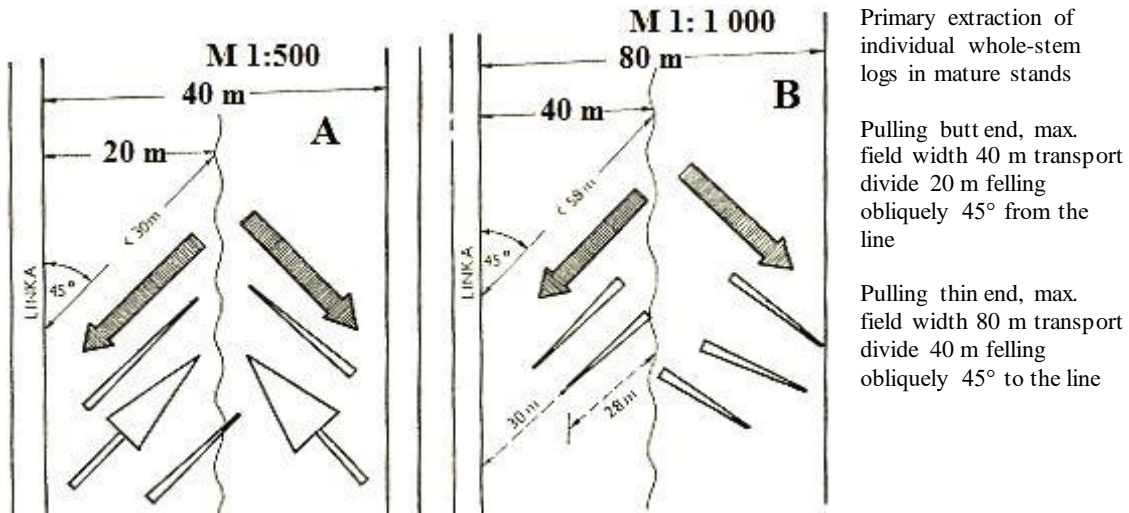


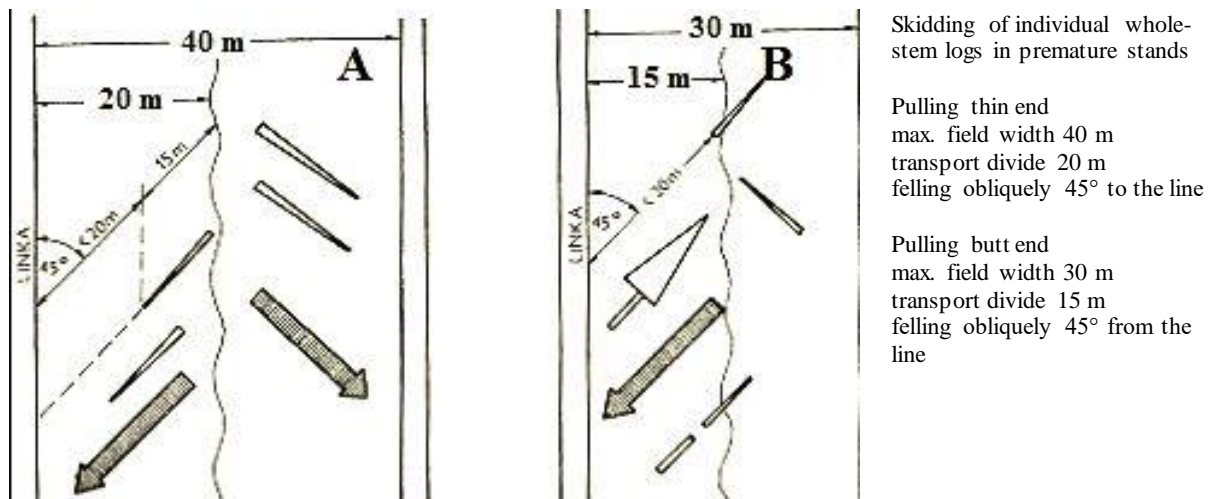
Fig. 90. Timber stacking on the deck

### Principles for the arrangement of workplaces at choker skidding of timber

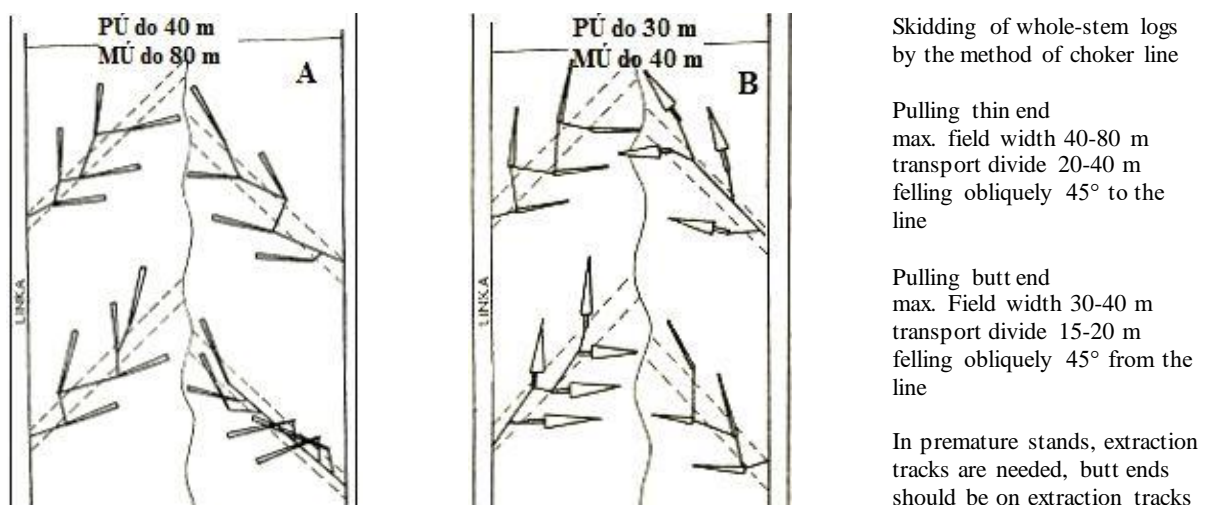
Stands have to be divided into working fields by a system of skidding lines and strip roads (see Chapter 15); this will provide access to the stand inside for skidding means and for primary extraction of timber by winch cable. Skidding line is a permanent or temporary gap in the stand, whose width corresponds to the width of skidding means, usually 3-4 m. Humus should not be removed from the gap surface the treatment of which by tractor blade should be minimized (modification of ramps). The direction of timber transport on lines is specified within technology preparation with respect to the location of landings and decks, transport divides and slope gradients. The workplace is a part of the stand determined for logging, lines for timber skidding and decks. It is useful to mark workplace edges with warning signs (tapes) etc indicating danger areas. Skidding methods should move only along the lines even on clear-cut areas in favourable terrains (to protect the soil). Moving outside the line is permitted only exceptionally (for turning). On slopes, the lines should be preferably led at right angles to the contour. Spacing of lines (working field width) depends on the method and means for primary extraction and skidding.



**Fig. 91. Spacing of skidding lines at choker skidding of individual timber pieces in main felling by pulling the butt end (A) and the thin end (B)**



**Fig. 92. Spacing of skidding lines at choker skidding of individual timber pieces in intermediate felling by pulling the thin end (A) and the butt end (B)**



**Fig. 93. Spacing of skidding lines at choker skidding of timber by the method of choker line in intermediate and main fellings by pulling the thin end (A) and the butt end (B)**

## 5.4 Machines for chokerless skidding of timber by dragging

The trend of furnishing tractors and prime movers with devices for timber skidding by dragging without the touch of a human hand has been in existence for decades. The main principle of chokerless timber skidding by dragging is grabbing and gripping timber by a tongs-shaped tool that may be a grapple or a clam bunk. Both are equipped with hydraulically controlled jaws which grip the timber. A difference between them is in the position of jaws that point downwards in the grapple and upwards in the clam bunk. Directional felling is an important factor in efficient chokerless timber skidding; in the case of bundling, another important factor is the placement of stems with butt ends in the skidding direction, on sides of the line, in a longitudinal or slightly slant position. **Grapples** exist in two options

- on a longer boom (6-8 m and even more) for loading, unloading and moving of bundles, even up to a height of several metres, grapple hold is relatively small (0.5-0.7 m) and can take one or two pieces. These grapples are included in the equipment of forwarders and trailers, some prime movers (HSM, LKT 82 C) and truck-and-trailer units;
- on a short boom (ca. 3 m) and with a greater clearance of jaws (1.3-2.0 m), allowing to grab a whole bundle of timber. On the boom, the grapple is suspended on the cross-swivel joint or the mounting is rigid. Jaws of some grapples are pulled through with tight cables improving the load grip and preventing the loss of pieces.

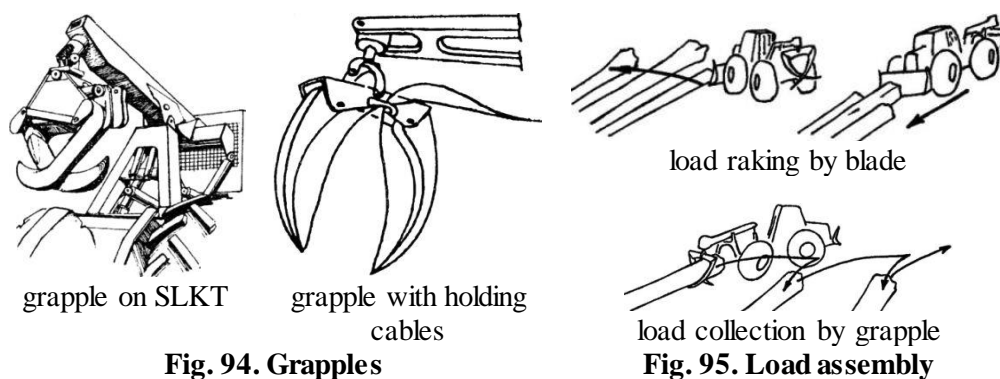


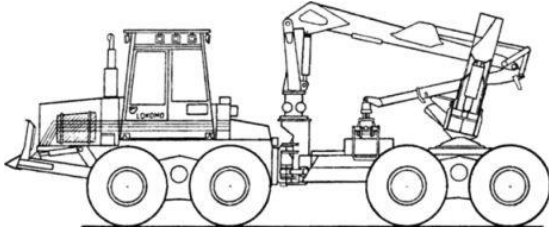
Fig. 94. Grapples

Fig. 95. Load assembly

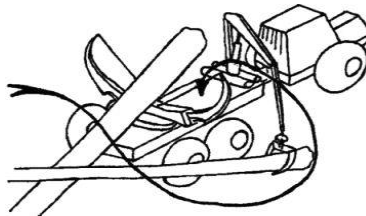
**Grapple** (forceps) **on a short boom** is behind the rear axle on UKT, usually on the 3-point linkage, and the boom can be usually deflected both to sides and height; this makes it possible that when cornering, the driver can deflect the boom to the sides, thus optimizing the load passage with minimum damage to surrounding trees. On SLKT, grapples can be fixed above or in front of rear axle, which improves weight distribution. Grapples can be mounted together with winches allowing to clear timber from places unreachable by the grapple. Grapples can be operated in the intermediate felling (after bundling of timber by horse into piles on the line) as well as in the main felling. Examples of grapples can be AUER types 1300, 1700, Timberlift, Maxwald, Nokka. The material has to be bundled namely in the intermediate felling, i.e. bundles have to be made, which are then grabbed by the grapple and skidded to the roadside landing. In the absence of bundling, labour intensity of skidding increases disproportionately. Disadvantages of this skidding method include travelling across the whole logging site as the tractor with the boom has to travel to each piece; worse usability in demanding terrains – tractors with grapples cannot come over difficult places using a procedure similar to snubbing. Tractors with this equipment are currently used minimally in the Czech Republic.

**Clam bunk** is determined for skidding long timber in semi-suspension when the load partly dwells on the bunk and partly is dragged on the terrain surface. It is mounted on undercarriages of forwarders instead of stanchion body. As the machines find not so many applications, their manufacturers choose a kit design when a forwarder with stanchions can be reconstructed into a tractor with the clam bunk if needed (efficient deployment is from 300 m<sup>3</sup> of timber) in 30 minutes. Cross-section of clam bunk is 1.2-2.0 m<sup>2</sup>, which allows large loads and high output of skidding. Timber falling out of the bunk is prevented by tight ropes pulled through the jaws. Trees or trunks are individually grabbed by the grapple mounted on the boom and inserted properly arranged between the bunk jaws that have to be gripped before the machine starts driving. A tractor with the clam bunk carries a greater load on the rear axle than a tractor towing the load on the cable; this is why the first machines had a higher rated footprint

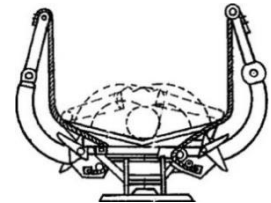
pressure; however, current machines feature the rated footprint pressure comparable or even lower thanks to multi-wheel undercarriages, double axles and wider tyres. Tractors with the clam bunk have the centre of gravity positioned higher, which puts certain limits on their transverse stability (8-10 %). Although their performance is high, they have some technological limitations (cannot manage sharp elevation positions where the load does not touch the ground and the axle is overloaded in convex terrains, and the undercarriage is “broken” by the load in concave terrains; in sharp directional positions, the marginal trees of the line are damaged by the butt ends of the load). Therefore, careful technological preparation is a must before their deployment. They are useful for concentrated logging after disasters, on clear-cuts, logging due to air pollution etc. They are currently used minimally in the Czech Republic.



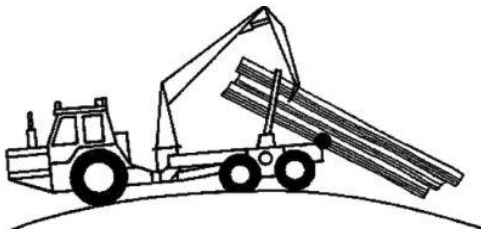
**Fig. 96. Prime mover LOKOMO 933 C with the clam bunk**



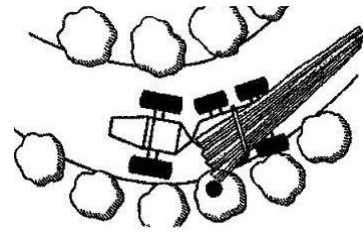
**Fig. 97. Loading of stem into the clam bunk**



**Fig. 98. Clam bunk**



**Fig. 99. Overloading of rear axle in convex arch**



**Fig. 100. Damage to marginal trees of the line in sharp directional arch**

Recently, wheeled skidders (SLKT) combine winch and grapple on a longer hydraulic boom + alternatively a skidder shield or a clam bunk. Examples are machines such as HSM 704 (shield), HSM 805, HSM 904 (bunk), Wellte - types W 110, 150, 180 and the Slovak prime mover LKT 82 C. The solution is promising as it puts together advantages of different principles into one unit. Timber bundling is recommended for better machine use especially in the intermediate felling. An advantage of skidding with these machines is a better guiding of the skidded piece and hence a low impact onto the stand.



**Fig. 101. Prime mover HSM 805 with the clam bunk, grapple on hydraulic boom and winch**

## 5.5 Timber forwarding machines

At **forwarding**, the load of timber dwells on the cargo area of the transport device, placed between the stanchions. Forwarding is a technological phase consisting of primary extraction, load assembly, haulage, sorting at the roadside landing, stacking on the landing or deck, and travelling into the stand. Because the timber transport units and forwarders are equipped with the hydraulic boom (less accurately referred to sometimes as hydro-manipulator, hydraulic arm) with a grapple, all operations can be performed by just one machine. In such a case, timber is extracted from the stand by the hydraulic boom within a distance given by its reach (6–8 m), and the load is assembled continually onto the cargo area. This option is possible in the main and intermediate motor-manual felling's but it is economically only slightly suited for the improvement felling due to low efficiency in clearing individual pieces of wood and short reach of the boom into the stand. This is why an option dominates in the improvement felling when the timber is cleared in advance from the stand and stored at the forwarding line, and only then is forwarded by the timber transport method.

**Benefits of skidding timber by forwarding** include reduced physical effort of workers as compared with the binding of chokers, lower dependence on weather, elimination of some unpleasant operations (tying and untying of chokers in mud or snow, forcing one's way through weeds, undergrowth and slash), reduced risk of injuries (most accidents happen at choker skidding of timber by damaged – frayed rope); increased daily performance of workers up to 60 m<sup>3</sup> of skidded timber (even over 200 m<sup>3</sup> in favourable conditions), which is unfeasible if chokers are bound and winch cable is pulled in manually; and the soil surface does not get disturbed by log butt ends. As to customer-supplier relations, it is important that timber is not being damaged or polluted by dragging on the ground. (Costs of sharpening and replacement of cutting tools – saw blades and bands, saw discs – are higher by 80-100 CZK/1 m<sup>3</sup>. This is why some customers give a bonus for the forwarded timber or bill a price deduction for timber skidded by dragging.) The effect of the weight of transported load on the traction of forwarders and units with all-wheel drive is specific as compared with the influence of the weight of load dragged by skidders and prime movers. Adhesive strength of forwarding machine significantly increases under the influence of load weight but driving resistance caused by increased rolling friction of wheels increases only slightly. When the load is dragged behind the tractor, its adhesive strength increases only a little bit (may even be reduced due to the lightening of front driven axle), while the resistive force of load (dragged burden) shear friction significantly increases.

The risk of wheel slip in forwarding means is not so acute as in tractors and prime movers at dragging timber, and this type of damage to the soil (milling of ruts by slipping wheels) is lower. Although the **risk of soil compaction** is increasing due to a greater load at machine travel, the problem can be resolved by the increased number of wheels, by double-wheels on axles (bogie axles), tracked wheels, increased tyre width, as well as by means of organizational and technical measures.

**A disadvantage** of the forwarding units and forwarders is their limited employment in field conditions. Terrain ruggedness must not make the machine passage impossible

- the terrain inclination of up to 45 % is suitable for timber skidding at right angles to the contour; at higher gradients, the machine stability is compromised and its manoeuvrability is significantly impaired
- the high position of the centre of gravity (cargo area is up to 145 cm above the ground) impairs the transverse stability of loaded machine; this is why on greater inclinations, loaded forwarders should be moving perpendicularly to contour lines. Some forwarders (John Deere) have a tiltable cargo space which is hydraulically tilted toward the slope; this favourably affects the position of gravity centre and improves transverse stability. A measure to increase longitudinal stability is fastening of machines to cables of special traction winches – e.g. Forcar FC200 made by Herzog and winches of other manufacturers
- in higher terrain inclinations, vehicles cannot manage exits from the strip road into the terrain and vice versa due to their larger turning radius – exits must be adjusted accordingly within the workplace preparation
- in conspicuously concave and convex terrains, problems may arise with the vehicle length (10 m and more with the load).



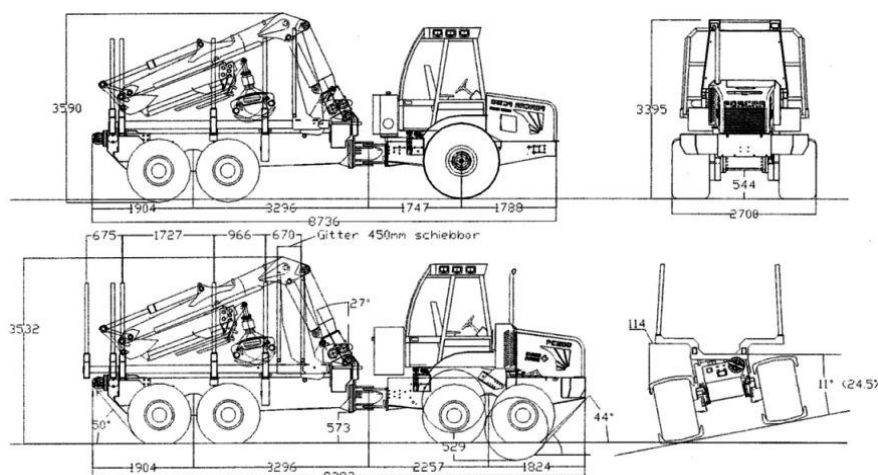
The **semantic difference between tractor and trailer unit** (timber transport unit) **and forwarder** is of essential character as it directly relates to technological possibilities of the two machines.

**Forwarder** is a special compact machine determined for timber loading, forwarding and stacking; it consists of engine part and cargo part, which are on two semi-frames connected by joint (axial or central); machine control is articulated by means of hydraulic system, all wheels are driven and load carrying capacity is usually markedly higher than that of tractor and trailer units.

**Tractor and trailer unit** is represented by a temporary connection of two separate means into one unit: tractor or prime mover and trailer, of which each can be used separately for other purposes. Simple units have tractor and trailer coupled with a firm shaft, drive of trailer wheels is not available, or there is only a hydraulically driven pinion between the wheels of double (bogie) axle. More advanced trailer designs include hydraulically articulated shafts facilitating and improving the guidance of trailer by the tractor when driving (reversing). In favourable conditions, they can be a purposeful alternative (purchasing cost lower by up to 50 %) to forwarders, and their performance in favourable conditions can be up to 90 % of forwarders (this is however not the rule). Annual timber volume forwarded by tractor and trailer units is 2 000–8 000 m<sup>3</sup>.

#### Differences between tractor and trailer unit and forwarder in respect of use

- in the forwarder, the travel direction is not much affected by the complexity of driving (especially when it is not loaded and visibility from the cab is not impaired by the load)
- in simple tractor and trailer units (without the hydraulically articulated shaft), reversing on the lines is practically impossible and the travel direction is affected by the complexity of driving (even without the load and with a good view from the cab)
- in advanced tractor and trailer units (with the hydraulically articulated shaft), reversing is easier, travel direction is somewhat less affected by the complexity of driving than in simple units (especially when they are unloaded and the view from the cab is not impaired by the load)
- traction capabilities of simple tractor and trailer units with undriven trailer wheels are considerably lower than in forwarders or tractor and trailer units of advanced technical standard with all-wheel drive; it follows that the simple tractor and trailer units feature a limited climbing capacity as well as a possibility of tractor wheel slipping.



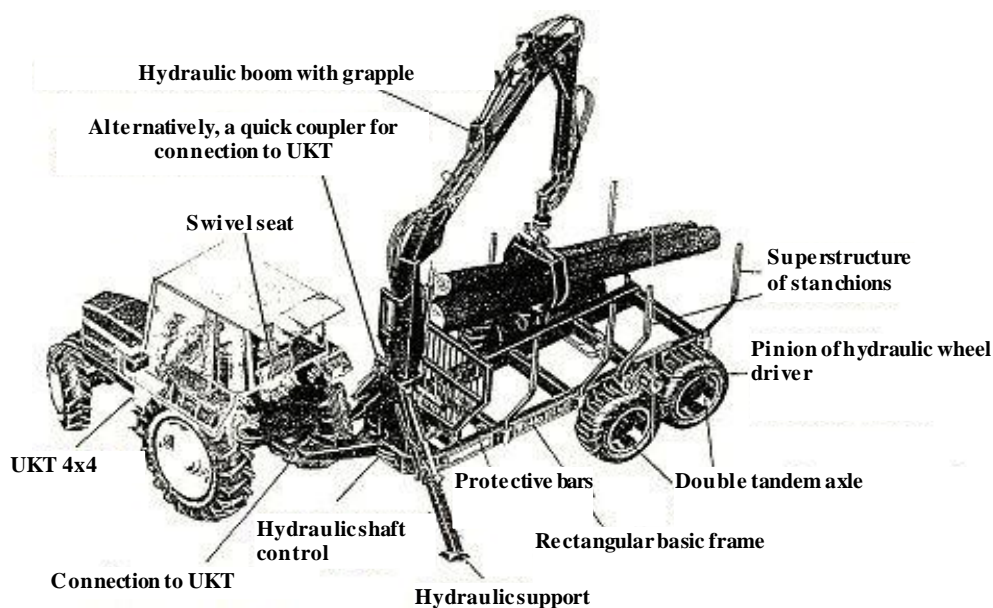
**Fig. 102. Forwarder Forcar FC 200  
with security winch, sliding stanchions and tiltable cargo space**

**Forwarding machines** (both tractor and trailer units and forwarders) are referred to as **assortment machines** (or **stanchion machines**), as they serve to transport stacked assortments and short logs (up to 6 m), and are equipped for the purpose with the superstructure of stanchions (stakes) into which the timber is placed in full length. Operating on public communications they have to be provided with a fastening facility preventing an accidental log falling out (in the forest, the load is not fastened), and the vehicle has to have a complete lighting including brake and tail lights (which are covered in forest not to suffer damage). Behind the cab, there is a front panel (bars, shield) to prevent the load from shifting onto the driver's cab when braking. Some types have a sliding shield (or sliding stanchions) to facilitate

load forwarding when transporting logs of different lengths. Stanchions (stakes) of forwarding machines are bent to inside the cargo space at an angle adequate to max. transverse inclination of the machine not to damage marginal trees on the line when travelling in transverse tilt.

### Design characteristics of assortment tractor and trailer units and forwarders

**Assortment tractor and trailer units** usually use UKT 4x4 with output up to 70 kW as an **energy device**, exceptionally a special wheeled prime mover. Supporting part of the unit is a single axle trailer with stanchions and hydraulic boom with the grapple. Trailer **design** consists of supporting frame, backbone tubular beam in lighter trailers, heavier trailers have a rigid rectangular frame made of steel profiles.



**Fig. 103. Tractor and trailer unit**

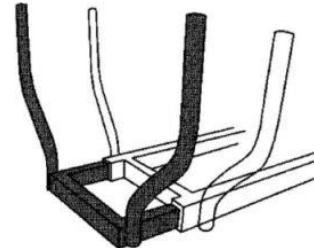
**Undercarriage** is single axled but usually with four wheels as double (tandem or bogie) axles are usually used. The axles are situated in the rear third of the frame (in some types, they are even longitudinally adjustable – for a better load distribution between trailer and tractor, which improves tractor stability and traction), and they are equipped with service brakes. Some trailers are also equipped with a steerable axle. The simpler types of trailers are without the drive of wheels (which is considerably limiting unit traction, and hence its climbing capacity as well as load carrying capacity). Frequently used is a short-term auxiliary wheel drive by means of hydraulically driven pinions, inserted from outside between wheels on the bogie axle by the hydraulic cylinder (suitable tyre tread is necessary). The solution allows to increase the unit traction for a short time and thus to overcome difficult sections of the route. The more sophisticated trailers have undercarriage wheels with permanent drive with the required energy taken from the tractor PTO shaft. The **connection of trailers** to the tractor is by the shaft. The simplest trailers are equipped with a firm shaft only. The hydraulically articulated shaft and the interconnection of tractor rear and trailer shaft by double-acting hydraulic cylinder facilitate directional steering of the unit including reversing. Such a trailer connection is similar to the articulated steering of LKT; deflection angle is up to  $60^\circ$  (caused trailer deflection to side is up to 70 cm).

Hydraulic boom with a grapple and a side reach of 6-7 m is most often located behind the shaft in the front part of the trailer, and is controlled hydraulically from the tractor cab. Reach and load carrying capacity of hydraulic booms are the most important parameters illustrated by diagrams. The capacity of lift in dependence on unloading can be calculated from the lifting torque of the boom  $MZ$  [kNm]. To increase the unit stability at loading and unloading the cargo, the trailer is equipped with hydraulically adjustable supports which must be lowered before each loading or unloading, which is another characteristic difference compared with the forwarder which does not have such supports. The source of hydraulic pressure fluid for trailer mechanisms can be the external circuit of the tractor but trailers

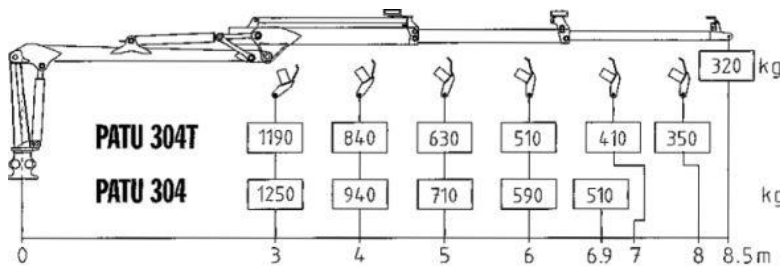
are more often equipped with a hydraulic pump of their own, powered by the tractor PTO shaft. Cargo space of the assortment trailer consists of 4-8 stanchions in the basic frame. On the trailer front, there is a protective front panel to prevent the cargo from shifting onto the cab when braking. Own weight of the trailer is usually 1-3 t, overall length 5.0-6.5 m, loading length ca 4.0 m. Load size is 5-12 t of timber (most often 8-10 t). Tractor and trailer units are used in easy terrain conditions; their indicative performance is 6-9 m<sup>3</sup>.h<sup>-1</sup>; it is advised to skid assortments that have been already sorted out. Advantage of tractor and trailer units is flexibility in forwarding lower amounts of timber, possibility of moving on public roads at higher speeds, and tractors can be used also for other works.



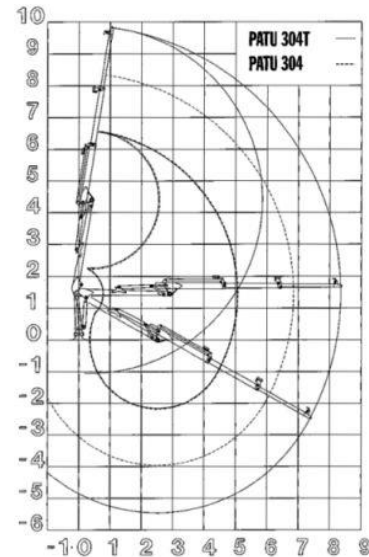
**Fig. 104. Non-driven and pinion-driven bogie axle**



**Fig. 105. Sliding stanchions**

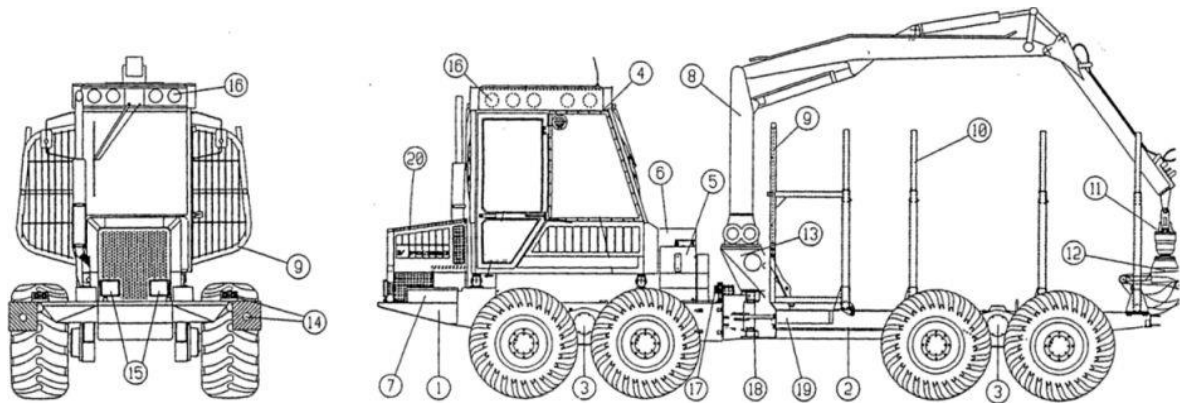


**Fig. 106. Diagram of hydraulic boom lift**



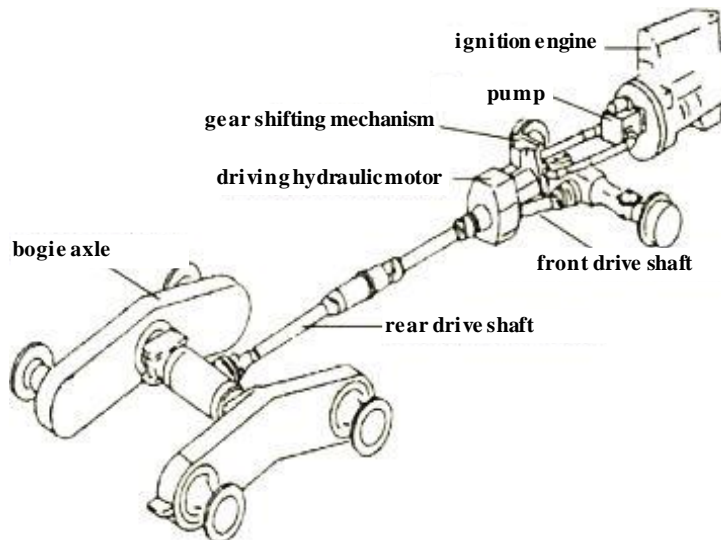
**Fig. 107. Diagram of boom reach**

Assortment forwarders are self-propelled machines forwarding short timber assortments. Their basic part is the frame chassis consisting of the front and rear semi-frames connected by axial or central joint and tilted against each other by means of hydraulic system (articulated construction similar to LKT). This is why the tractor can travel and manoeuvre in both directions, which is further facilitated by the operator's swivel seat. For easier reversing, new types are equipped with camera scanning the space behind the machine. The front semi-frame carries engine, transmission systems and cab, the rear semi-frame carries cargo space with stanchions. A boom with grapple is most frequently located on the rear semi-frame near the central joint, rarely on the cab roof. Boom reach is 6-8 m, but there are also booms with a reach of 10 m. Forwarders are equipped with the arrest of axial joint or swing axles in order to increase the chassis rigidity and transverse stability of the machine at loading and unloading. Thus, they are not provided with adjustable supports like tractor and trailer units, which makes the work easier and faster. Cargo space is 4 m long and bordered with 2x4 stanchions (adjustable too) and protective bars. Maximum length of transported assortments is 6 m. Load volume of 2-3 m logs is 10-20 m<sup>3</sup>. According to load capacity, forwarders are distinguished into small (up to 6 t), middle sized (up to 10 t) and large (up to 18 t). Engine power is 70-140 kW in dependence on the load capacity. External width of forwarders is about 2.5 m; however, there are smaller machines on the market with engine power ranging only from 40-50 kW and width of ca 2 m.



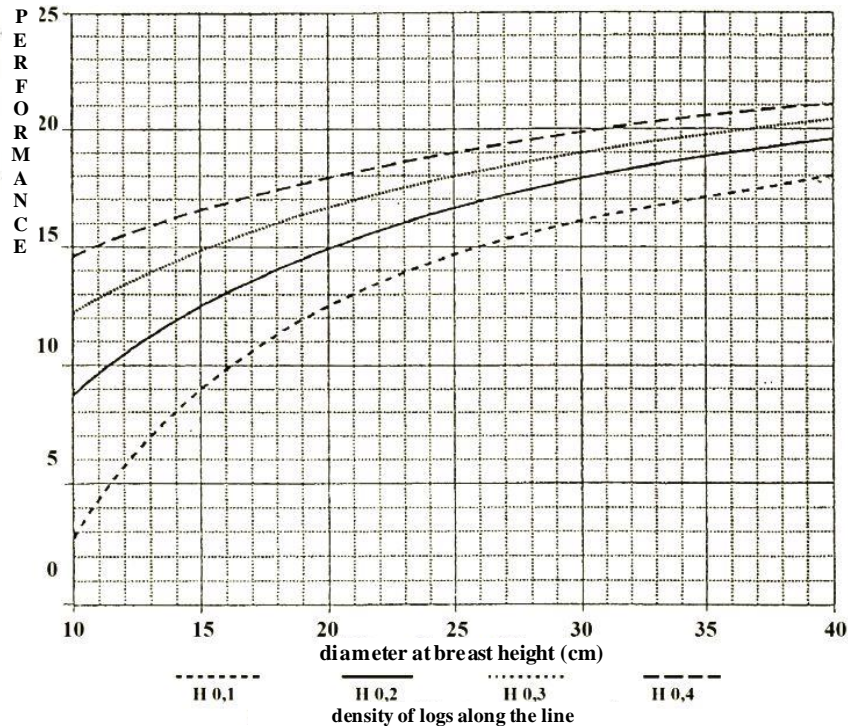
1 front semi-frame, 2 rear semi-frame, 3 double bogie axles, 4 safety cab, 5 fuel tank, 6 hydraulic fluid tanks, 7 tool box, 8 revolving boom column, 9 protective bars, 10 stanchions, 11 rotator, 12 grapple, 13 supporting frame of hydraulic crane, 14 spotlights and reflectors, 15 lights for driving, 16 light for working, 17 arrest of axial joint, 18 axial joint, 19 hydraulic cylinder of articulated steering, 20 engine cover

**Fig. 108. Schematic of forwarder**

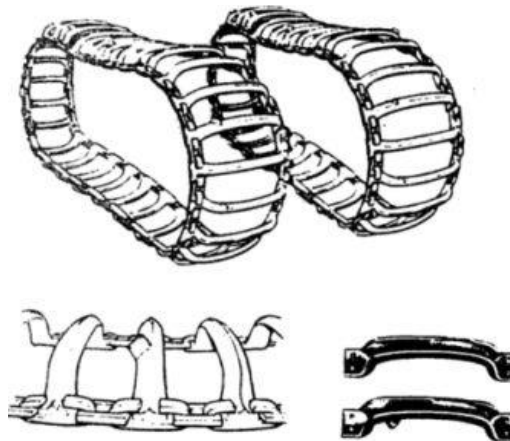


**Fig. 109. Schematic of forwarder chassis**

Forwarders have **wheeled** or **tracked undercarriage (chassis)**. Wheeled chassis has 6 or 8 wheels (2 big wheels in front and 4 smaller wheels in the back on bogie axles, or two-times two bogie axles) with tyres min. 600 mm in width. Wheels of bogie axles can be tracked for moving in terrains with poor load carrying capacity. **Forwarders are used** primarily for skidding assortments up to 6 m in length, made by harvesters and placed at skidding lines also in more difficult terrains. Pre-condition for their efficient use is a higher concentration of harvested timber. **Advantages of forwarders** include high work productivity, big load capacity, good terrain passability, good ergonomic and safety conditions for the operator, possibility of sorting and stacking assortments by the boom, environment-friendly deployment thanks to low specific pressure on the soil, large ground clearance and minimum pollution of timber at skidding. Forwarders feature higher performance than transport means for long timber even in lower stem volumes and at longer transport distances. At a distance from 200-400 m, their performance range is 5-12 m<sup>3</sup>/h.

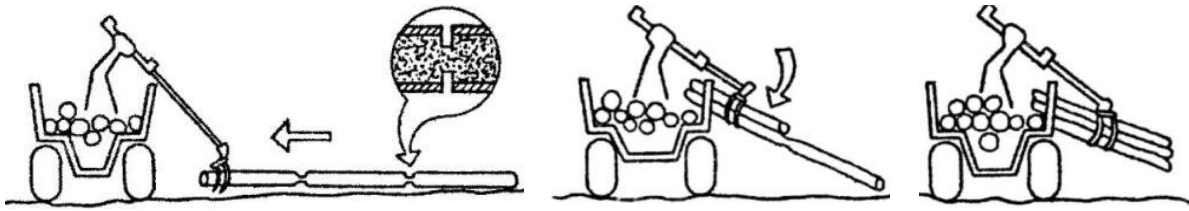


**Fig. 110. Forwarder performance in dependence on stand DBH and concentration of logs at the line**



**Fig. 111. Tracks**

**Work techniques** with forwarders and tractor and trailer units differ in the whole-area main felling, and in the improvement and selective fellings. In the whole-area felling, primary extraction can be integrated with load assembly because forwarders can usually move along the lines that are located on the logging site at sufficient density. In the improvement felling, the movement of forwarders is limited to the lines only and this is why primary timber extraction to them has to be done by another means (harvester, horse, winch, manual piling). Prepared piles (stacks) must be located in gaps between the trees, outside the line passage profile! The forwarder then assembles the cargo by loading up the prepared piles. An exception from the rule is “breaking” of combined log lying near the line. This procedure is used in motor-manual logging when the chainsaw operator fells and delimits a tree near the line and indicates the lengths of to-be logs only by cuts on both sides. The operator then carefully skids the combined log to the line and “breaks” it onto the cargo area. Logs from trees distant from the line must be brought to the vehicle by hand. The procedure is very skill-intensive both for the logger and the operator.



**Fig. 112. “Breaking” of combined log onto the forwarder cargo area**

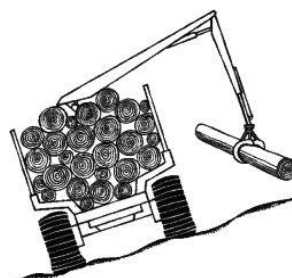
There is a rule for the movement of all forwarding machines across the terrain and on the lines that they are much more sensitive to transverse inclination due to high gravity centre than tractors skidding timber by dragging. This is why the machines are allowed to move on lines where longitudinal and transverse gradients are combined only without the load, and travelling with the load is permitted only along the lines without the transverse inclination! If the travel of forwarding machine along the contour line cannot be prevented, the machine is balanced by sweeping the hydraulic boom against the slope (possibly grabbing a log into the grapple). When a forwarding machine travels along the contour line, timber should be loaded onto the cargo area only from the space above the line to eliminate the risk of machine overturning due to the tilting moment of hydraulic boom and burden. It is typical for tractor and trailer units (simpler and low-cost models in particular) that the linkage of towing vehicle and trailer is loose and does not allow active directional steering of the trailer at reversing. Regarding the fact that the ability of such units to reverse into a blind line is very limited and almost not existing, skidding lines should be preferably routed as continuous. Reversing with forwarders is easier as the principle of their steering is identical or similar to articulated steering. This is why forwarders can operate also on the pattern of lines providing access, of which some are blind. Nevertheless, as to optimization of works and low impact on the soil, the lines should be designed as continuous even in this case to eliminate unnecessary passage of machines along the same track. If a forwarder becomes stuck when travelling with the load (at a place of poor ground bearing capacity on the line), there is many a time no other solution than to unload a part of cargo next to the line and skid it with the next travel with the load only (when the forwarding machine is not equipped with a rescue winch).

#### **Basic requirements for a network of lines for forwarding machines**

- marking of lines in the stand is a task for the technologist not for the operator
- at higher slope gradients, lines should be inserted perpendicularly to contour lines
- minimum stump height on the line should be looked at already at felling or the stump height can be reduced additionally (risk of damage to trees and machines, risk of machine overturning)
- width of lines according to machine size 3.5-4.5 m (and more for ramps on primary logging roads)
- parallel arrangement of lines is preferred
- number of blind lines should be minimized.



**Fig. 113. Hitting a stump can result in machine overturning or damage to trees next to the line**



**Fig. 114. Balancing the machine in transverse inclination by boom with the log**

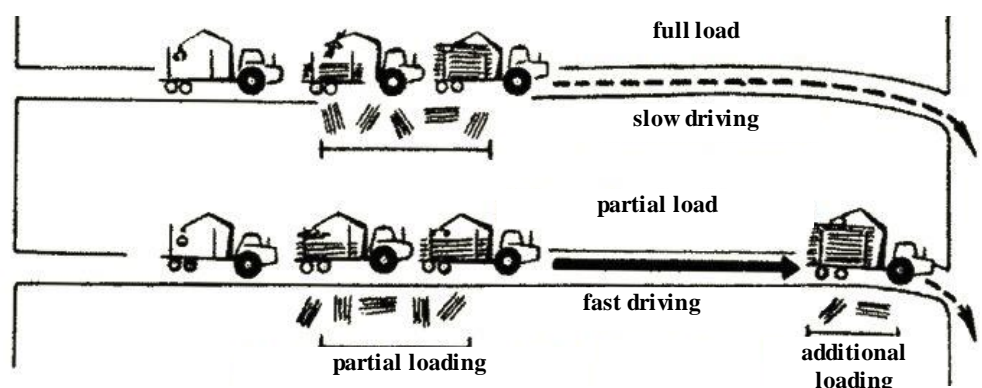


Fig. 115. Schematic of forwarder loading and driving

**Driving** with the fully loaded forwarding machine is slow; this is why gradual loading can be more suitable at longer transport distances. A part of the cargo is loaded at the beginning of track, the machine continues driving at a higher speed to the end of track where additional cargo is loaded, and reduced speed is used at the roadside landing. In forwarders, this procedure is particularly faster than systematic loading as they do not have to tilt supporting legs for each loading. **Timber unloading** is done by the hydraulic boom with the grapple while the logs are sorted and stacked. In some cases, **using the assortment machine for timber hauling** can be useful. This is when the transport distance is so short that a longer time can be saved by eliminating one loading and unloading of cargo than is a difference in time consumption for hauling by automobile as compared with the time consumption for hauling by the slower forwarding machine. In some European regions, the haulage of short logs by the assortment forwarding machine is quite common in mountain areas in which the pattern of roads is dimensioned just for them and does not allow the operation of more sizeable truck and trailer units at all.

### Model technologies of primary timber extraction

**Power saw + manual timber piling + assortment forwarding machine** is used in the improvement felling, motor-manual assortment method, variant of standard lengths, when the forestry worker piles (skids) the produced short logs to the line along which skidding is implemented by the assortment forwarding machine.

**Power saw + horse + processor + assortment forwarding machine** is used in the improvement felling when whole trees are skidded by horse to the line, and after having been processed by processor and placed to the line, the produced logs are transported by the assortment forwarding machine.

**Power saw + mobile winch + processor + assortment forwarding machine** is used in the improvement felling when whole trees are skidded to the line by mobile winch, and logs are transported by the assortment truck and trailer unit after having been processed by processor.

**Power saw + tractor winch + processor + assortment forwarding machine** this solution is similar to the two above cases with a difference that the felling can be integrated with the primary extraction of felled trees.

**Harvester + assortment forwarding machine** is currently a typical example of timber forwarding technology. It is used both in the improvement felling and in the regeneration felling. The harvester cuts trees, brings them onto the line where they are delimbed and processed into assortments that are placed outside the passage profile of the line in the improvement felling and piled on the logging site in the regeneration felling. Forwarding is usually implemented by the assortment forwarder (not by the truck and trailer unit the performance of which is usually considerably lower compared with the performance of harvester).

### 5.6 Combined ground-based timber skidding

**Combined skidding** of timber means that one machine extracts timber from the stand to the skidding line where it prepares the load (wood piles) on the forest edge landing (VM) for another machine which finishes the phase of timber skidding by skidding the timber along the line and by stacking it on the

roadside landing. The combined skidding of timber is used in cases when it appears as purposeful **for economic reasons** (the sum of direct costs incurred is lower than direct costs that would have to be incurred by using a single machine), **time reasons** (the combination saves time as compared with using a single machine) or **ecological reasons** (the combination of machines is more environment-friendly than using a single machine). A concurrence of these reasons is however quite common.

### **Usual combinations of timber skidding means**

The below combinations do not represent an exhaustive outline of all existing options but only those whose application is realistic in the conditions of the Czech Republic.

#### **Horse + tractor (UKT, SLKT)**

It is primarily used in the improvement felling when the horse brings the timber to the line and the assembled load is then skidded by the tractor. The distance of skidding by the horse should not exceed 40 m (50 m). The main advantage of this combination consists in the fact that skidding (movement of each piece along a separate route) is done by the energy-efficient means, and thanks to the manoeuvrability of the horse, the low-impact timber skidding is less laborious for the operator than skidding by winch cable, which would require a frequent change in re-hanging directional pulleys. At skidding the timber on the line, the tractor can utilize its tractive force and higher speed of movement. Whether a combination of the horse with UKT or SLKT is used, does not depend on terrain characteristics as the tractor operates on the line rather than across the terrain. There should be no terrain inequalities on the line and gradients above 25 % usually occur only in a very few lines. The choice between UKT and SLKT is affected primarily by the skidding distance because at longer skidding distances, the deployment of higher performing and faster SLKT can be more advantageous even in the terrains of a group. Damage by skidded timber to trees standing in the stand is higher in the combination with SLKT than in the combination with UKT as the assembling of larger loads indirectly causes a greater share of timber skidded along suboptimal extraction routes.

#### **Tractor (UKT, SLKT) + cable transport installation**

The combination is used in the case that a terrain of low bearing capacity, a terrain with obstacles or a watercourse has to be overcome after primary extraction and skidding by wheeled vehicle along a part of the route. In such a case, the cable transport installation serves as a hauling cableway and is not used for primary extraction and assembly of timber load.

#### **Cable transport installation + tractor (UKT, SLKT)**

This combination is usual when the efficient length of LDZ route does not allow its ending at the roadside landing (OM), and at the same time, the terrain characteristic allows to consider the end point of LDZ as a forest edge landing (VM), and to skid timber by tractor therefrom. It is ideal to use the full-tree harvesting method, and to perform delimiting at the forest edge landing (VM) or between VM and OM. The same applies in cases when tractor has to be used for pulling timber away from the cableway skyline. (In this case, the tractor can be used for simultaneous delimiting by the branch-trimming unit).

#### **Feller-buncher + SLKT (tractor with clam bunk)**

In this combination, the feller-buncher performs primary extraction (clearing) with making bundles for the following skidder. It is a very effective combination with respect to the fact that load assembly consumes up to 1/3 of time from the entire cycle of timber skidding. Using the feller-buncher therefore considerably increases the performance of the subsequent skidder. If the following operation is delimiting by processor on the roadside landing, tractor with the clam bunk (which drives out from the load) is more useful in terms of time than SLKT in which the load placing on OM lasts much longer and causes a longer idling time of the processor.

#### **Manual timber piling + assortment forwarding machine**

The combination is used in the motor-manual assortment method, in the variant of standard lengths, when the lumberman piles (skids) short logs (usually 2 m long) to the line along which forwarding is then performed by the assortment forwarding machine.



### Harvester + assortment forwarding machine

The combination is used in both improvement and regeneration felling. Harvester cuts the trees and brings them to the line where it delimits them and makes assortments. Forwarding is performed by the assortment forwarding machine.

### Horse + harvester + assortment forwarding machine

This combination is used in the improvement felling when a larger spacing of skidding lines is required than a double arm reach of the machine. Having been cut by one-man power saw, trees outside the harvester reach are extracted by horse to a place from the line that is reachable by the boom and are processed by the operator. Regarding the different performance of the means and the need to ensure safety work for all participating persons, the felling by power saw and the extraction of timber (trees) by horse have to be made in advance.

## 6. Occupational safety and health

### 6.1 Safety cabs and frames of machines

Risks threatening a machine crew differ according to the kind of activity and place of its performance. Therefore, the machine operator must be to some extent protected by the safety cab (frame) that is subject to approval under an OECD (Organization for Economic Cooperation and Development) methodology. The authorized organization in the Czech Republic is The Government Testing Laboratory of Machines for Agriculture, Food Industry and Forestry in Prague. It is practically impossible to manufacture a cab that would not be deformed at all when the machine overturns. Machines at which the risk of turnover exists must be thus provided with a cab ensuring a sufficient survival space (protected space) for the crew in case of machine turnover. If the machine is not provided with such a cab, it must be fitted additionally with the protective frame meeting the same criteria. The structure of such a cab or frame is referred to as **ROPS** (Roll-Over Protective Structure) and sometimes as **TOPS** (Tip-Over Protective Structure). If there is a risk of objects falling from height on the cab during machine working (stones on machines working below a quarry wall, risk of branches, tree crowns, and whole trees falling on logging machines), it must be provided with a structure protecting the crew against the penetration of such objects to the cab – by **FOPS** (Falling-Object Protective Structure) structure referred to sometimes as **FOG** (Falling-Object Guard). Penetration of objects (branches at driving along the line, torn cable of winch whipping towards the cab, torn off glide or choker etc.) into the cab threatens at work in the forest. It should be prevented by **OPS** (Operator Protective Structure), which is mostly a protective grate on the cab windscreen. In the farmer's equipment of tractors for skidding, OPS is reduced to a protective type of net integrated in the winch structure. If the FOPS (FOG) and OPS protection is integrated in the logging machines, it is referred to as **OPG** (Operator Protective Guard). It should be borne in mind that the protection of the ROPS type can be effective, only if the operator is secured by safety belt and does not use the cab as a storeroom. If the means of transport rolls over, the operator is as a rule not injured by the machine overturning itself but by axe, saw, tools or canister transported in the cab.

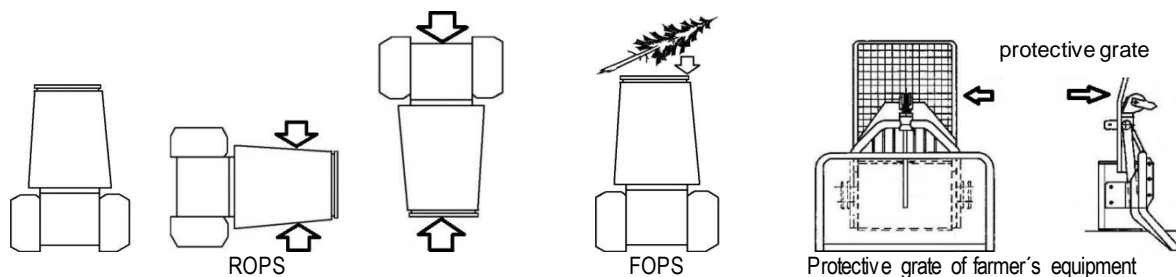


Fig. 116. Functions of protective structures

### 6.2 Manoeuvrability of vehicles on slopes

In longitudinal inclination, the vehicle loses manoeuvrability if the load of any axle decreases below 1/3 of its static load on the flat ground. Typical situations are uphill start (reduced front axle load and overloaded rear axle) and braking at downhill drive (reduced rear axle load and overloaded front axle).

The area of good vehicle controllability corresponds to the slope inclination up to ca. 1/3 of static stability angle, i.e. to the climbing ability marked in the tractor cab that corresponds to the static stability angle at safety factor 3 (factor 3 is used in the Czech Republic, it is lower, however, in many countries). The lateral static stability margin of a vehicle for critical situations caused by dynamic effects (transverse slip, skid, swing at driving up on an obstacle and driving down from an obstacle) is not mathematically quantifiable as yet, and given the need of such a margin, safety factor 3 is used in the Czech Republic, too. Details on determining the stability of mobile machines see Chapter 6.3.1.

### 6.3 Occupational safety and health in the European Union

The European Union's activities in the field of occupational safety and health (OSH) are legally anchored in the article 137 of the **Treaty of Nice** (now the article 153 **Treaty on the Functioning of the European Union**). Within the European Commission the Directorate-General for Employment, Social Affairs and Inclusion deals with the OSH issue. At the European Parliament level, this topic belongs to the Committee on Employment and Social Affairs and this issue is addressed by the Council Employment, Social Policy, Health and Consumer Affairs Council at the level of the European Union. OSH is also the subject of activities for two agencies of the European Union: European Agency for Safety and Health at Work and European Foundation for the Improvement of Living and Working Conditions.

In the European Union, the basic requirements for OSH are formulated in the Council **Directive 89/391/EEC** — measures to improve the safety and health of workers at work. The framework directive is supplemented by individual directives that address specific health and safety issues. The most important follow-up directives include: **Directive 2009/104/EC** concerning the minimum safety and health requirements for the use of work equipment by workers at work, **Directive 89/656/EEC** on the minimum health and safety requirements for the use by workers of personal protective equipment at the workplace, **Directive 2003/10/EC** on the minimum health and safety requirements regarding the exposure of workers to the risks arising from physical agents (noise), **Directive 2002/44/EC** on the minimum health and safety requirements regarding the exposure of workers to the risks arising from physical agents (vibration), **Directive 98/24/EC** on the protection of the health and safety of workers from the risks related to chemical agents at work and **Directive 89/654/EEC** concerning the minimum safety and health requirements for the workplace. The Member States of the European Union will ensure the implementation of EU regulations into national legislation.

Other legally binding OSH documents can be the labour standards of the International Labour Organization (ILO). The tripartite agency ILO brings together governments, employers and workers of 187 member states. In 2006 ILO introduced the International Labour Standard for the **Promotional Framework for Occupational Safety and Health Convention**, which has so far been ratified by 49 countries around the world. Another tool that the ILO uses to improve OSH in the forestry are Codes of Practice. These Codes set out practical guidelines for public authorities, employers, workers and enterprises, however they are not legally binding documents. Both the Forest Stewardship Council (FSC) and the Program for the Endorsement of Forest Certification (PEFC) refer to ILO documents related to OSH in the forestry.

When selling a product in the European economic area, the manufacturer shall provide a declaration of conformity (CE marking) with the essential health and safety requirements defined in Directive 2006/42/EC on machinery. To demonstrate conformity, the manufacturer uses a number of harmonized standards of the European Union, see Commission communication in the framework of the implementation of Directive 2006/42/EC on machinery.

In the European Union, The Rapid Alert System for Non-Food Products (RAPEX) is used under the auspices of the European Commission. If a product is placed in the European economic area and does not meet the requirements of the relevant European standards, a warning is issued to consumers and further steps are taken, usually withdrawing the product from the sales network. For example, since 2005, 17 alerts have been issued in this system concerning chainsaws. The most frequent problems concerned the chain brake, hand guard and grip area.

### 6.4 Key principles of work safety at timber skidding

Tractors for timber skidding and skidders / truck-and-trailer units can be operated only by staff with the tractor driving licence, holders of machine operator certificates and holders of a licence for operating radio stations in case of tractors controlled by command radio stations.

Protective gloves (leather or cut-proof) must be used at work with cables and chokers and a protective helmet for working in the stand (outside the machine cab). Frayed cable chokers must be discarded.

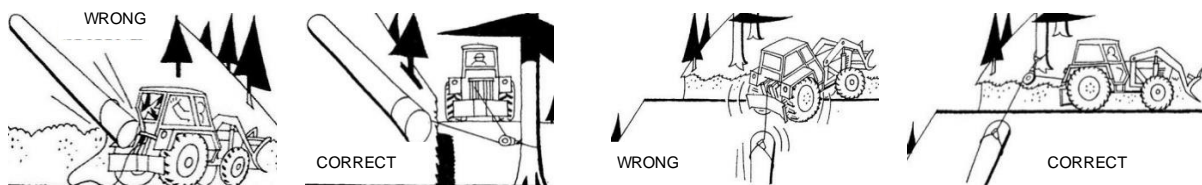
Hearing protectors shall be used at machines exceeding the permitted noise level.

Machine operator must be secured by safety belts while driving.

At putting loads together for the tractor, chokers are always tied to skidded timber first, and only then the prepared choker is hooked up on the glide of winch cable. Fingers must not be inserted between the choker and the log at binding chokers.

While working, the mechanist and the chute assistant (assistant driver) must use agreed clear signals for winding the cable, stop of winding, winch drum brake off, and particularly for immediate emergency stop of winding.

In terrains with the risk of spontaneous timber movement, timber is skidded downhill using a winch cable only if the tractor stands outside the hazardous area.



The tractor must not stand in the direction of timber movement at cable skidding downhill. The tractor stands in a safe area and timber is skidded using a guide block.

A guide block is used at cable skidding from a ravine so that the tractor cannot be swept by timber set in motion at random.

**Fig. 117. Winch cable skidding**

Forwarders/tractor-and-trailer units must not be used on lines with the crossfall putting the machine's stability at risk. The movement of forwarders/tractor-and-trailer units without loads only is permissible on lines, the crossfall of which is close to that limit. Timber loading on a moving forwarder/tractor-and-trailer unit on a transverse slope is possible only from the upper side.

Timber skidding by tractors and forwarders/tractor-and-trailer units downhill on a slope with limit inclinations is permissible under good adhesion conditions, for a short distance, on direct and easy to survey routes, and at reduced speed only. In skidding timber by dragging, it is appropriate to skid whole trees as their friction brakes the driving speed.



Tractors with front pushers have them in the lowest position when driving so as not to make the tractor centre of gravity higher

Friction of whole trees brakes the driving speed on lines with limit inclination

If the tractor turns around on the slope, it is appropriate to secure it with the rope

Loaded tractor-and-trailer units /tractors must not drive on lines with the cross fall putting their stability at risk

**Fig. 118. Some principles of safe timber skidding**

Vehicle driver must hold a driving licence for the relevant vehicle category. If the vehicle is equipped with a hydraulic crane (hydraulic loader), he must have a licence for its operation.

Hydraulic crane is a lifting device that is by law subject to regular revisions which the vehicle owner must ensure and maintain documentation on them.

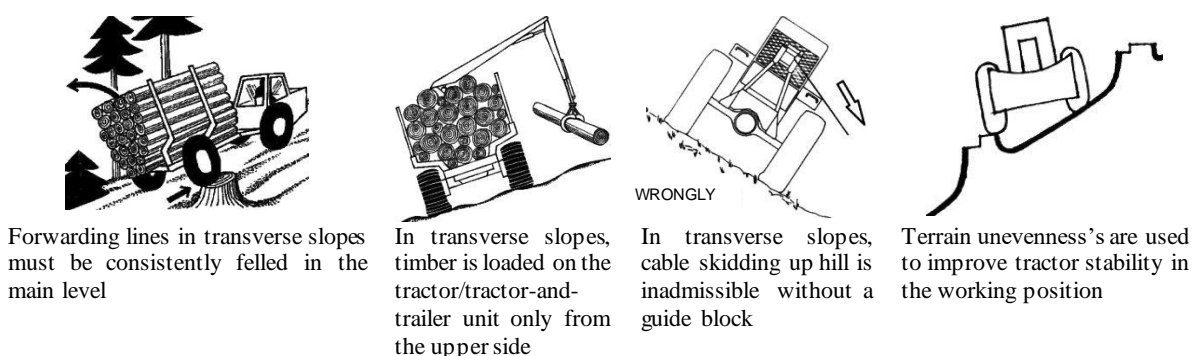


Fig. 119. Some principles of safe timber skidding

## 6.5 Practical recommendations for OHS

**Minutes from the OHS training** provide a necessary alibi document proving that the particular technical employee fulfilled the obligation to train workers. It is therefore necessary that the factual content of training minutes and its formal design are not done sloppily (quote standards, operational instructions, directions etc.) and it must not be forgotten to have the attendance list signed by all participants in the manner: name - signature.

**Re-examination in OHS** must be provable too; therefore, the same applies as in the above.

**Workplace hand-over** in the form of record must be confirmed by the signature of the taking over person in the service book at least. A brief record indicating specificities of the workplace (e.g. overhead power lines in the proximity, work on the slope etc.) is sufficient. The record should not be postponed but entered immediately at handing the workplace over! 'Murphy's law' namely functions, accidents and injuries happen frequently during the very first hours of work at a new workplace.

**Routine OHS check at the workplace** should be recorded at least in the service book. It shall include what was wrong, what was pointed out to a worker, what he was reprimanded for, what sanction was imposed. An oral reprimand should be signed by worker as a proof that he has acknowledged it. At accident examinations, it is used commonly as a means of proving that the company has fulfilled its obligation of continually checking occupational safety.

**Particularly risky works** should be carried out under direct management of technical-economic employee (salvage felling, special technologies, using of explosives, and works, at which it is directly prescribed by a special rule - bench blasting).

**A vehicle for the transport of persons** shall be parked always in the direction of departure at the workplace and in such a way that it is not obstructed by anything and can leave without delay in the event of accident.

**Adjustment and maintenance** are carried out only on the machine that has been stopped. Before their start, the ignition key shall be taken out of the switch box so that the machine cannot be started even by mistake. The key must not be left in the ignition of machine put out of operation for the same reason. It is not allowed to test the leakage of screwed joints, pipes, and hoses by an unprotected finger because of the risk of burns and eczemas. Protective goggles and gloves shall be used at checking and during the maintenance of accumulator; smoking close to the accumulator is not allowed. Xenon bulbs may be changed when they are cold or in gloves and only with the electric circuit of lights switched off because of live voltage!

At **ascending to and descending** from the cab using stairs, the mountaineering principle of three fixed points shall be respected. Never jump down from stairs to the ground but descend because feet muscles are stiff from working in the cab and not prepared for dynamic load, and a foot sprain can also occur due to hitting uneven ground or slipping.

When starting work at a new workplace, it is very important to put down **GPS coordinates** of roadside landing on a visible and accessible place for a possible need to call medical aid.

**Approaching a working machine, stay in the field of the operator's vision** and call him by radio or mobile phone, if possible. By night, approach with a cycle flasher only and make hand gestures (also by day). Do not get near the machine, if it is not absolutely certain that the operator knows about you - e.g. engine is still running at operating speed. A safety distance of forwarders is 30 m, but in a harvester, not even 70 m may be enough when the chain breaks and lashes. Due to that reason, rather a larger danger area should be marked with the warning tape. If the machine operator sees a person in the hazardous area near to the machine, he must interrupt the work and raise hands from controllers – so as to exclude even an unintentional movement and so as the upcoming person can see the raised hands as a signal that the operator knows about him! The space between the chassis and the jib and the area of articulated steering must not be entered.

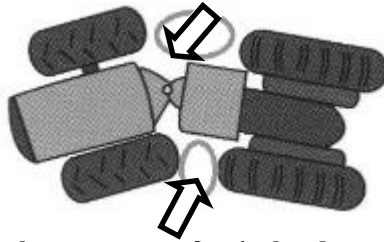


Fig. 120. Area endangered by the movement of articulated steering (do not enter these areas!)

**Marking colours in spray** must not be exposed to temperatures higher than 50° C and therefore they must not be left in the machine (or car) cab standing in the sun!

Do not try to jump out of cab **when the machine rolls over**, hold on tight instead! Keep the cab clean, without objects that might hurt you during the machine roll-over (axe, canister, tools).

Machines with articulated steering should not change the driving direction **when travelling in the line crossfall** (and angle on the hillside)! In particular, the operator must not swerve the steering against the slope because they would risk the machine stability by that! In the illustration figures, the dark arrow on the steering wheel shows the risk manoeuvre that may cause the machine to roll over.

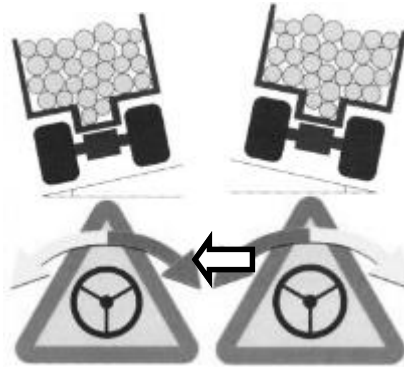


Fig. 121. Risk of roll over in the machine with articulated steering when the steering is swerved against the slope

## 7. References

- Baadsgaard - Jensen, J. (1988) *Comminution and application of forest residues*. Skovteknisk Institut Denmark.
- Bauer, F., Ryšavý, I. (1985) *Hydraulické systémy mechanizačních prostředků*. VŠZ v Brně, 140 p.
- Bozděch, J., Černák, J. (1986) *Tabulky hmotnosti ihličnatého a listnatého dřeva*. Alfa Bratislava.
- Černý, Z. (1989) *Stroje a technologie v pěstební výrobě*. VŠZ v Brně.
- Černý, Z. et al. (1983) *Mechanizace pěstebních prací*. VŠZ v Brně.
- Černý, Z., Neruda, J., Lokvenc, T. (1995) *Zalesňování nelesních půd*. IVV MZe ČR.
- Douda, V. et al. (1974) *Mechanizační prostředky lesnické*. SZN Praha.
- Drápal, D. et al. (1980) *Hydraulická ruka v lesním hospodářství*. Praha.
- Dressler, M. (1977) *Bezúvazkové soustředování dříví*. Praha.
- Dressler, M. (1982) *Význam a uplatnění limitujících faktorů pro těžební technologie*. Lesnický průvodce č. 2, Praha.
- Dressler, M., Popelka, J. (1974) *Přibližování dříví universálními a speciálními traktory*. SZN Praha.
- Erler, J. a kol. (2012) *Forsttechnik*. TU Dresden.
- Grečenko, A. (1963) *Kolové a pásové traktory*. SZN Praha.
- GUV: (2005) *Seilarbeit im Forstbetrieb*. GUV-I 8627 Bundesverband der Unfallkassen, München.
- Havlíček, J. et al. (1989) *Provozní spolehlivost strojů*. Státní zemědělské nakladatelství v Praze, 610 p. ISBN 80-209-0029-2
- Jurča, V. (2004) *Informační systémy v oblasti údržby*. Učební text pro vzdělávací program ČSPÚ „Manažer údržby“. 64 s.
- Jurča, V., Hladík, T. (2006) Maintenance Data Evaluation. *Exploatacja i niezawodnosc*, č. 3/2006. Polish Maintenance Society. Warsaw. ISSN 1507–2711
- Klíma, J. a kol. (1982) *Lesář – dřevorubec*. SZN Praha.
- Kostrůň, L. et al. (1971) *Lesní těžba a dopravnictví*. Praha.
- Legát, V. et al. (2007) *Systémy managementu jakosti a spolehlivosti v údržbě*. Česká společnost pro jakost. 192 p. ISBN 978-80-02-01979-7
- Legát, V. et al. (2008) *Jakost, spolehlivost a obnova strojů*. (Učební texty) ČZU, Praha, CD. ISBN 80-813-1514-8
- Löffler, H. (1986) Bodenschäden bei der Holzernte, Ursachen, Folgen, Vorbeugung. *Holz – Zentralblatt*, Nr. 149, s. 2190-2192.
- Matthies, D. (1998) Möglichkeiten und Grenzen für die Definition einer ökologischen vertredlichen Befahrbarkeit KWF Workshop. *Forsttechnische Informationen*, Nr 3, pp. 29–36.
- Meng, W. (1978) *Baumverletzungen durch Transportvorgänge bei der Holzernte*. Stuttgart.
- Messingerová, V. (2001) *Lesné dopravníctvo*. Návodový do cvičenia. TU Zvolen.
- Míkleš, M. (1999) *Teória mobilných strojov*. TU Zvolen.
- Moudrý, J. a kol. (1980) *Práce v komplexních čtách*. Praha.
- MZ ČR (1992) *Příručka pro majitele lesa*. Praha.
- Nadezhdina, N., Prax, A., Čermák, J., Nadyezhdin, V., Ulrich, R., Neruda, J., Schlaghamersky, A. (2012) Spruce roots under heavy machinery loading in two different soil types. *Forest Ecology and Management*, sv. 282, č. October, s. 46-52.
- Němec, J. (1959) *Technická příručka lesnická*. SZN Praha.
- Neruda, J. (1995) *Technika pěstební výroby*. MZLU v Brně, 114 p.

- Neruda, J., Simanov, V., Klvač, R., Skoupý, A., Kadlec, J., Zemánek, T., Nevrkla, P. (2013) *Technika a technologie v lesnictví. Díl první*. Brno: Mendelova univerzita v Brně. 364 p. ISBN 978-80-7375-839-4
- Neruda, J., Simanov, V., Klvač, R., Skoupý, A., Kadlec, J., Zemánek, T., Nevrkla, P. (2013) *Technika a technologie v lesnictví. Díl druhý*. Brno: Mendelova univerzita v Brně. 300 p. ISBN 978-80-7375-840-0
- Neruda, J., Ulrich, R., Vavříček, D., Nevrkla, P. (2011) Interakce prostředí a parametrů strojů při optimalizaci technologických postupů lesní těžby. In: Skoupý, A. (ed.). *Multikriteriální hodnocení technologií pro soustředování dříví*. 1. vyd. Praha: Lesnická práce, s.r.o., pp. 1-19. ISBN 978-80-7458-016-1
- Neruda, J., Ulrich, R., Vavříček, D., Nevrkla, P., Fil'o, P., Kadlec, J., Pohořalý, J., Šedivý, V., Skoupý, A., Klvač, R. (2012) Analýza parametrů a souvisejících faktorů provozu výrobních technologií. In: Kulhavý, J., Menšík, L. (eds.). *Les a dřevo: podpora funkčně integrovaného lesního hospodářství a využívání dřeva jako obnovitelné suroviny: významné výsledky institucionálního výzkumu Lesnické a dřevařské fakulty Mendelovy univerzity v Brně v období 2005-2011*. 1. vyd. Brno: Mendelova univerzita v Brně, 2012. pp. 262-268. ISBN 978-80-7375-608-6
- Neruda, J., Valenta J. (2004) *Determinace poškození lesních porostů těžebními technologiemi*. Monografie. MZLU v Brně, Folia Universitatis Agriculturae et Silviculturae Mendelianae Brunensis.
- Neruda, J., Vavříček, D., Ulrich, R., Janeček, A. (2011) *Interakce stanoviště a těžebně dopravních strojů*. 1. vyd. Brno: Mendelova univerzita v Brně, 91 p. ISBN 978-80-7375-573-7
- Neruda, J., Walczyk, J. (2009) Progresivní směry technického rozvoje v lesních školkách. In: Foltánek, V. (ed.). *Novinky v nabídkách mechanizačních prostředků k využití ve školkách*. 1. vyd. Brno: Sdružení lesních školkařů ČR, pp. 7-23. ISBN 978-80-7399-849-3
- Novák, L. (1982) *Technologie těžby prořezávkového materiálu*. VÚLHM, Závěrečná zpráva výzkumu.
- Pernis, P. (2005) Lesnické traktory a jejich bezpečnost I a II. *Forest Magazin*, Praha, č. 1.
- Petříček, V. et al. (1984). *Mechanizační prostředky v lesnictví*. SZN Praha.
- Pohořalý, J., Neruda, J., Kleibl, M., Hubálková, I. (2012). Soil bearing capacity detection according to changing humidity as a damage prevention caused by forest machinery movement. In: *VII Krakowska Konferencja Młodych Uczonych*. 1. vyd. Krakow: Grupa Naukowa Pro Futuro, p. 219. ISBN 978-83-62218-64-6
- Pošta, J. (2002) *Provozuschopnost strojů*. (Učební texty) ČZU, Praha, 95 p. ISBN 80-213-0966-0
- Rónay, E., Bumerl, M. (1982) *Doprava dřeva*. Bratislava.
- Rónay, E., Dejmal, J. (1991) *Lesná ťažba*. Bratislava.
- Rousek, M. (1996) *Tekutinové mechanismy a vzduchotechnika*. MZLU Brno.
- Simanov, V., Kohout, V. (1993) *Asanace erozní rýhy*. Výukové video, AVC VŠZ v Brně, 10,0 min.
- Simanov, V., Kohout, V. (2004) *Těžba a doprava dříví*. Písek.
- Skoupý, A. (1990) *Návrh optimalizovaného systému péče o lesní techniku*. (Výzkumná zpráva úkolu č. VI-6-/06-06). Vysoká škola zemědělská v Brně, 65 p.
- Stanovský, M. (1990) *Mechanizácia výchovy a výroby dreva v predrubných porastoch*. Lesnícke informácie. Príroda Bratislava.
- Svaz zaměstnavatelů dřevozpracujícího průmyslu, Společenstvo dřevozpracujících podniků v ČR, Česká asociace podnikatelů v lesním hospodářství, Lesy České republiky. (2002) *Doporučená pravidla pro měření a třídění dříví v České republice*. Svaz zaměstnavatelů dřevozpracujícího průmyslu, Společenstvo dřevozpracujících podniků v ČR, Česká asociace podnikatelů v lesním hospodářství, Lesy České republiky, Praha – Hradec Králové.
- Škapa, M. et al. (1987) *Lesní těžba*. Praha.
- Štaud, V. et al. (1963). *Technologická typizace a příprava pracovišť na úseku soustředování dříví*. Praha.

- Štaud, V. et al. (1983) *Umělá obnova lesa*. Technika a technologie. SZN Praha.
- Štollmann, V., Koska, P. (2001) *Lesnícke mechanizačné prostriedky*. Návody na cvičenia. TU Zvolen.
- Štollmann, V., Mikleš, M. (2001) *Lesnícke mechanizačné prostriedky*. TU Zvolen.
- Švenda, A. et al. (1983) *Technologie a příprava výroby dříví v lesním hospodářství ČSR*. Praha.
- Tomášek, L. (2003) *Pracovní postupy a zásady bezpečné práce při lesnických činnostech*. LČR s.p., Hradec Králové.
- Ulrich, R. (1989) *Stroje a technologie pro těžební výrobu*. VŠZ v Brně.
- Ulrich, R., Vavříček, D. (2013) *Certifikovaná metodika ukazatelů a systému technologických postupů v rámci těžební činnosti a udržitelného využívání lesních ekosystémů*. Osvědčení č. 49166/2013-MZE-16222/M66. MZe ČR, 45p.
- Wiesik, J. (1990) *Maszyny lesne I a II*. Wydawnictwo SGGW-AR Warszawa.



**Title:** Tractors and skidders in forestry

**Author:** prof. Ing. Jindřich Neruda, CSc., Ing. Pavel Nevrkla, Ing. Luboš Staněk,  
Ing. Tomáš Zemánek, Ph.D.

**Publisher:** Mendel University in Brno, Zemědělská 1, 613 00 Brno

**Edition:** first, 2023

**Number of pages:** 80

**ISBN 978-80-7509-954-9**

**<https://doi.org/10.11118/978-80-7509-954-9>**